

# 8220 THRU 8233

**PRELIMINARY INFORMATION**  
(subject to change without notice)  
February 18, 1999

## LOW-DROPOUT REGULATORS — HIGH EFFICIENCY

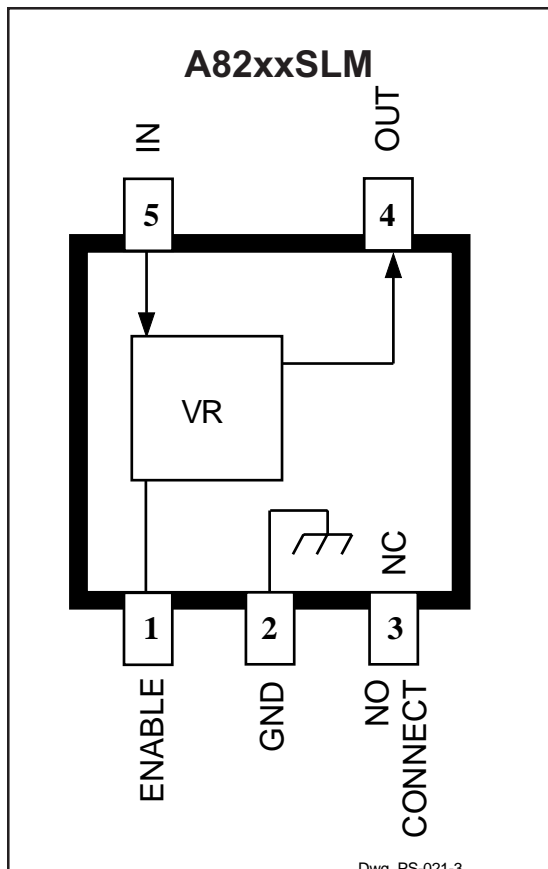

Dwg. PS-021-3

### ABSOLUTE MAXIMUM RATINGS

Input Voltage,  $V_I$  ..... 7 V

Peak Output Current,

 $I_{OM}$  ..... 100 mA\*Enable Input Voltage,  $V_E$  .....  $V_I$ 

Operating Temperature Range,

 $T_A$  ..... -20°C to +85°CJunction Temperature,  $T_J$  ..... +150°C

Storage Temperature Range,

 $T_S$  ..... -40°C to +150°C

\* Output current rating is limited by input voltage, duty cycle, and ambient temperature. Under any set of conditions, do not exceed a junction temperature of +150°C. See following pages.

Designed specifically to meet the requirement for extended operation of battery-powered equipment such as cordless and cellular telephones, the A8220SLM thru A8233SLM voltage regulators offer the reduced dropout voltage and quiescent current essential for maximum battery life. Applicable also to palmtop computers and personal data assistants, these devices deliver a regulated output at up to 100 mA (transient), which is limited only by package power dissipation. Regulated output voltages of 2.6, 2.7, 2.8, 2.9, 3.0 and 3.3 are currently provided. Other voltages, down to 2.0 volts, are available on special order.

A PMOS pass element provides a typical dropout voltage of only 125 mV at 50 mA of load current. The low dropout voltage permits deeper battery discharge before output regulation is lost. Quiescent current does not increase significantly as the dropout voltage is approached, an ideal feature in standby/resume power systems where data integrity is crucial. Regulator accuracy and excellent temperature characteristics are provided by a bandgap reference. The A8220SLM thru A8233SLM include ENABLE inputs to give the designer complete control over power up, standby, or power down.

These devices are supplied in a 5-lead SC-74A small-outline plastic package similar to the SOT-23. All devices are rated for operation over a temperature range of -20°C to +85°C.

### FEATURES AND BENEFITS

- High Efficiency Provides Extended Battery Life
- 125 mV Typical Dropout Voltage at  $I_O = 50$  mA
- 32  $\mu$ A Typical Quiescent Current  
Less Than 1  $\mu$ A "Sleep" Current
- Low Output Noise
- 100 mA Peak Output Current
- Improved PSRR and Transient Performance

### APPLICATIONS

- Cordless and Cellular Telephones
- Personal Data Assistants
- Personal Communicators
- Palmtop Computers

Always order by complete part number, e.g., **A82xxSLM**, where "xx" is the required output voltage in tenths.

# 8220 THRU 8233 LOW-DROPOUT REGULATORS

## FUNCTIONAL BLOCK DIAGRAM

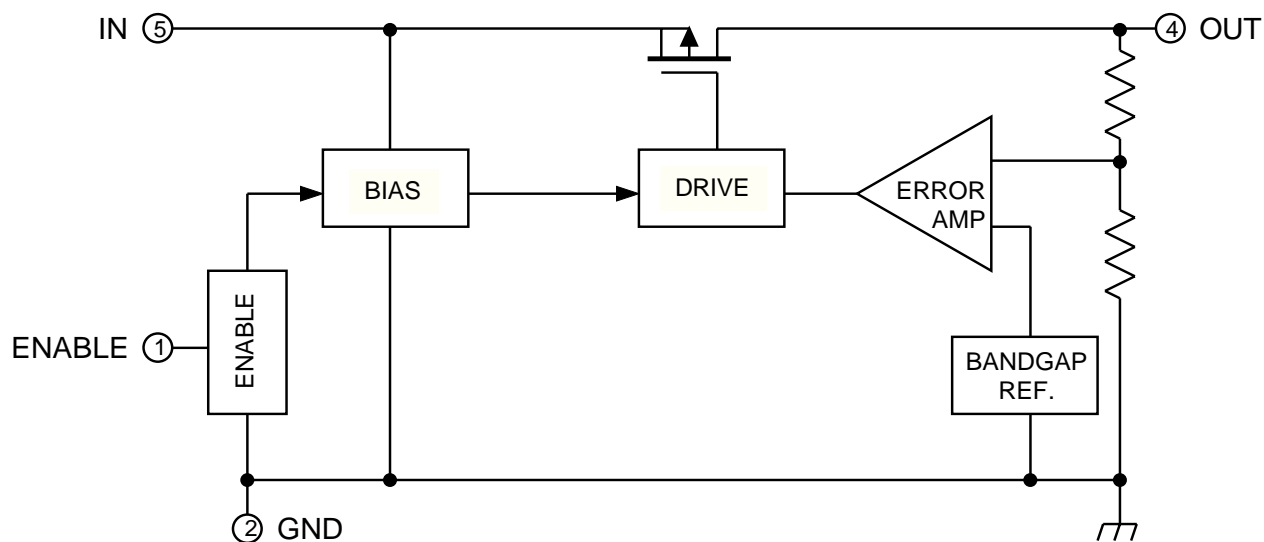

Dwg. FS-012-5

**A82xxSLM Maximum Allowable Average Output Current\*** with device mounted on 2.24" x 2.24" (56.9 mm x 56.9 mm) solder-coated copper-clad board in still air.

$T_A$	Allowable Total Average (10 ms) Output Current in Milliamperes with $T_J = 150^\circ\text{C}$ , Duty Cycle = 100%†						
	1.5	2.0	2.5	$V_I - V_O$ 3.0	3.5	4.0*	4.5*
25°C	100	100	100	100	100	100	100
50°C	100	100	100	100	100	100	100
70°C	100	100	100	100	100	91	81
85°C	100	100	100	98	84	74	66

\*Absolute maximum peak output current rating is 100 mA; absolute maximum input voltage is 7 V.

$$\dagger I_O = (T_J - T_A) / ([V_I - V_O] R_{\theta JA} \times dc) = (150 - T_A) / ([V_I - V_O] \times 220 \times 1.00)$$

Output current rating can be increased (to 100 mA maximum) by additional heat sinking or reducing the duty cycle.



# 8220 THRU 8233 LOW-DROPOUT REGULATORS

## ELECTRICAL CHARACTERISTICS at $T_A = +25^\circ\text{C}$ (unless otherwise noted).

Characteristic	Symbol	Test Conditions	Limits			Units
			Min.	Typ.	Max.	
Output Voltage (reference specified $V_{O(\text{nom})}$ )	$V_O$	$4\text{ V} \leq V_I \leq 7\text{ V}$ , $10\ \mu\text{A} \leq I_O \leq 50\ \text{mA}^*$	-0.09	0.00	+0.09	V
		$V_I = V_{O(\text{nom})}$ , $I_O = 50\ \text{mA}$	-0.25	—	—	V
Output Volt. Temp. Coeff.	$a_{VO}$	$V_I = 6\ \text{V}$ , $I_O = 10\ \text{mA}$ , $T_J \leq 125^\circ\text{C}$	—	-0.20	—	mV/ $^\circ\text{C}$
Line Regulation	$\Delta V_{O(\Delta V_I)}$	$4\ \text{V} \leq V_I \leq 7\ \text{V}$ , $I_O = 1\ \text{mA}$	—	3.0	10	mV
Load Regulation	$\Delta V_{O(\Delta I_O)}$	$1\ \text{mA} \leq I_O \leq 50\ \text{mA}^*$ , $4\ \text{V} \leq V_I \leq 7\ \text{V}$	—	—	20	mV
Dropout Voltage	$V_{I\text{min}} - V_O$	$I_O = 50\ \text{mA}$	—	125	250	mV
Ground Terminal Current	$I_{\text{GND}}$	$V_I < 7\ \text{V}$ , $V_E \geq 2.0\ \text{V}$ , $I_O \leq 50\ \text{mA}$	—	32	45	$\mu\text{A}$
	$I_Q$	$V_I \leq 7\ \text{V}$ , $V_E \leq 0.8\ \text{V}$ , $I_O = 0\ \text{mA}$	—	—	1.0	$\mu\text{A}$
ENABLE Input Voltage	$V_{\text{EH}}$	$4\ \text{V} \leq V_I \leq 7\ \text{V}$ , Output ON	2.0	—	—	V
	$V_{\text{EL}}$	$4\ \text{V} \leq V_I \leq 7\ \text{V}$ , Output OFF	—	—	0.8	V
ENABLE Input Current	$I_E$	$V_E = V_I = 7\ \text{V}$	—	—	$\pm 1.0$	$\mu\text{A}$
Rejection Ratio	PSRR	$V_I = V_{O(\text{nom})} + 1.5\ \text{V}$ , $V_i = 100\ \text{mV}$ , $I_O = 10\ \text{mA}$ , $f = 1\ \text{kHz}$ $f = 10\ \text{kHz}$	—	70	—	dB
			—	52	—	dB
Noise	$e_n$	$10\ \text{Hz} \leq f \leq 100\ \text{kHz}$ , $I_O = 10\ \text{mA}$ , $C_O = 10\ \mu\text{F}$	—	0.5	—	$\mu\text{V}/\sqrt{\text{Hz}}$

Typical values are at  $T_A = +25^\circ\text{C}$  and are given for circuit design information only.

\* Pulse test ( $\leq 20\ \text{ms}$ ). See previous page for duty cycle limitations.

# 8220 THRU 8233 LOW-DROPOUT REGULATORS

## TYPICAL CHARACTERISTICS

### LOAD REGULATION

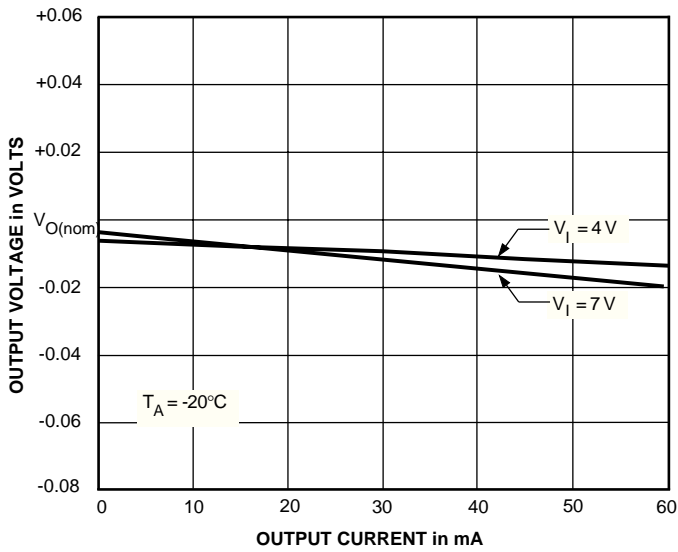

Dwg. GP-052-16

### LINE REGULATION

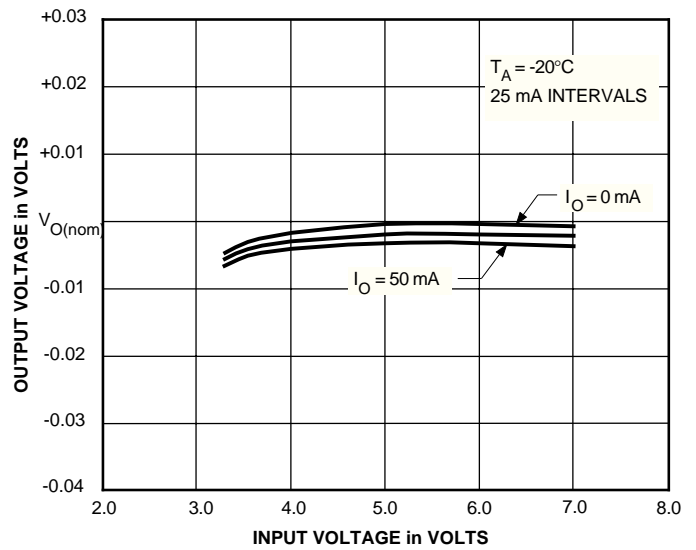

Dwg. GP-053-17

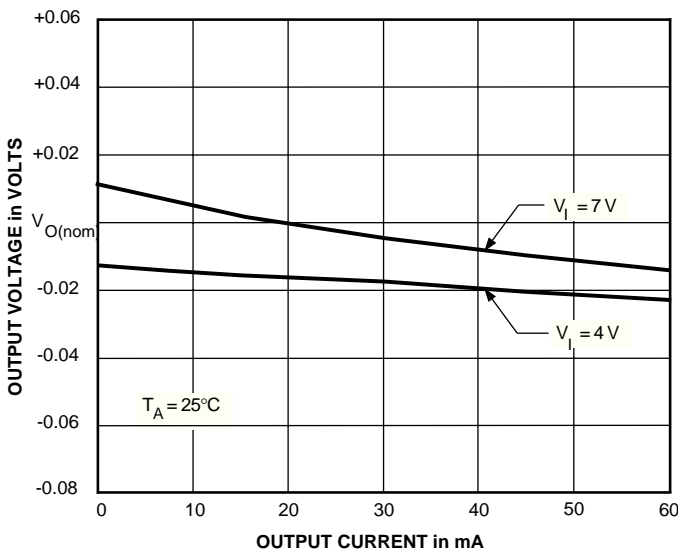

Dwg. GP-052-17

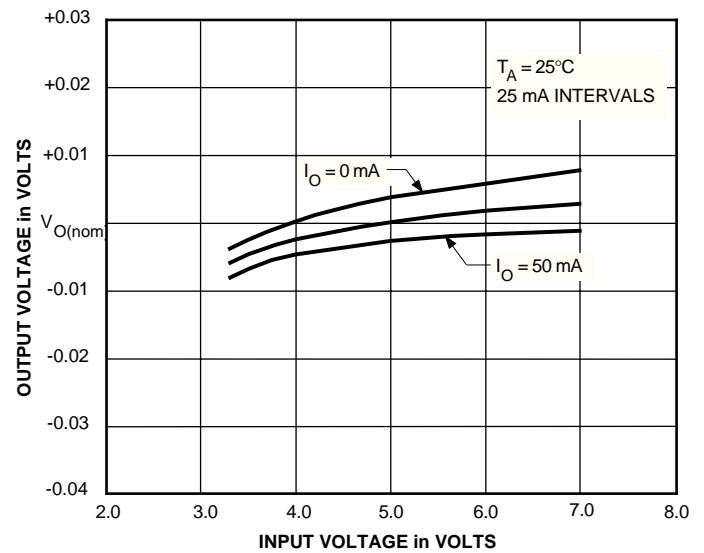

Dwg. GP-053-18

**CAUTION:** Maximum allowable duty cycle will be significantly less than 100% at high temperatures, at high input voltages, or at high output currents. See appropriate Maximum Allowable Output Current table.

# 8220 THRU 8233 LOW-DROPOUT REGULATORS

## TYPICAL CHARACTERISTICS (cont'd)

### LOAD REGULATION

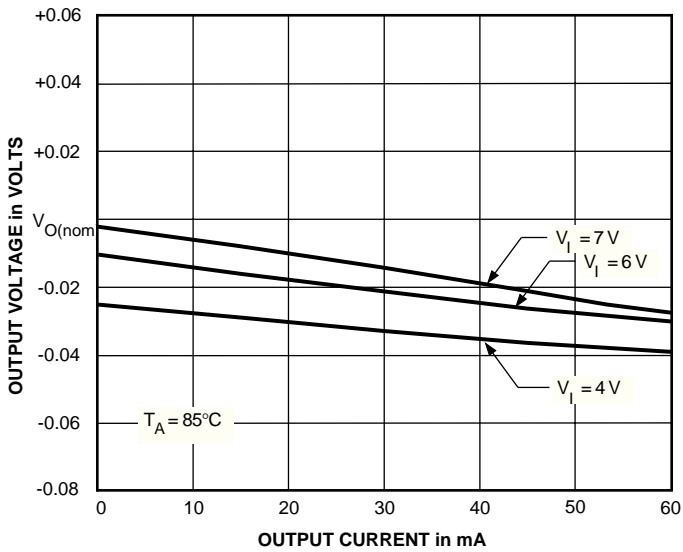

Dwg. GP-052-15

### LINE REGULATION

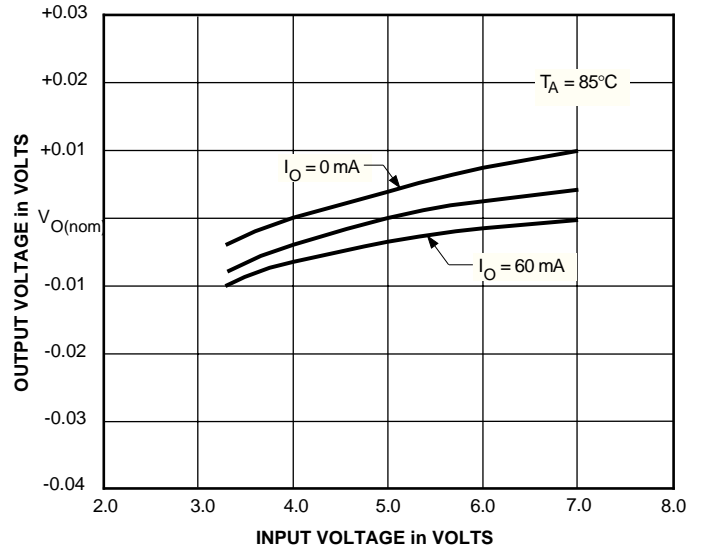

Dwg. GP-053-16

## OUTPUT VOLTAGE

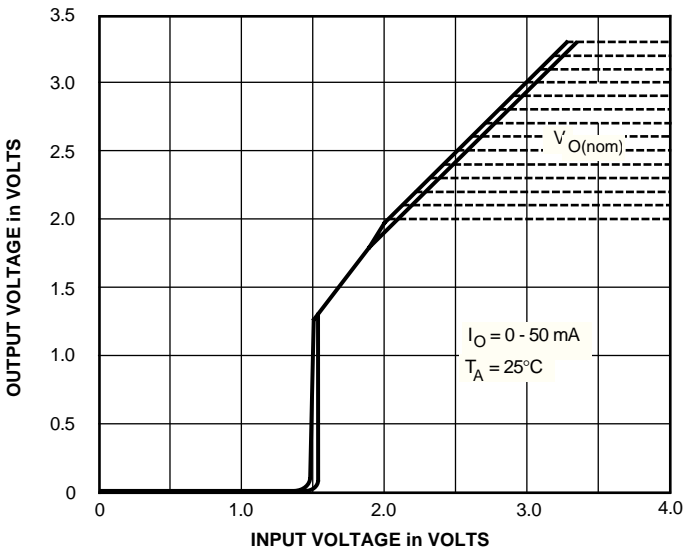

Dwg. GP-059-3

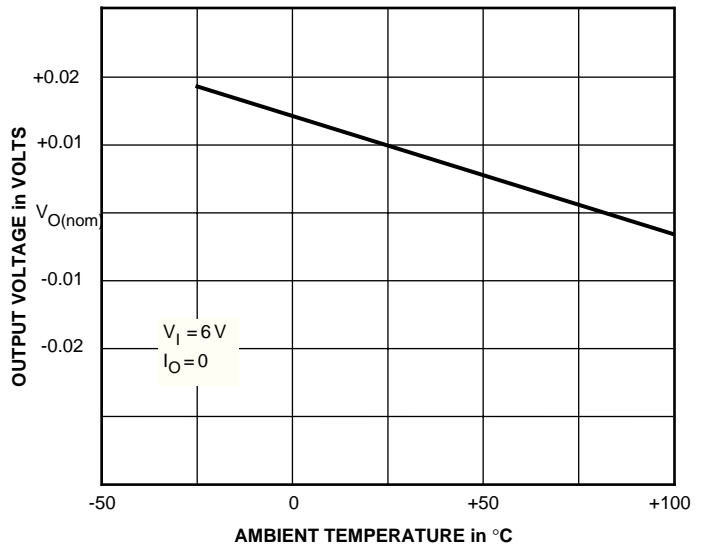

Dwg. GP-050-4

**CAUTION:** Maximum allowable duty cycle will be significantly less than 100% at high temperatures, at high input voltages, or at high output currents. See appropriate Maximum Allowable Output Current table.

# 8220 THRU 8233 LOW-DROPOUT REGULATORS

## TYPICAL CHARACTERISTICS (cont'd)

### GROUND TERMINAL/QUIESCENT CURRENT

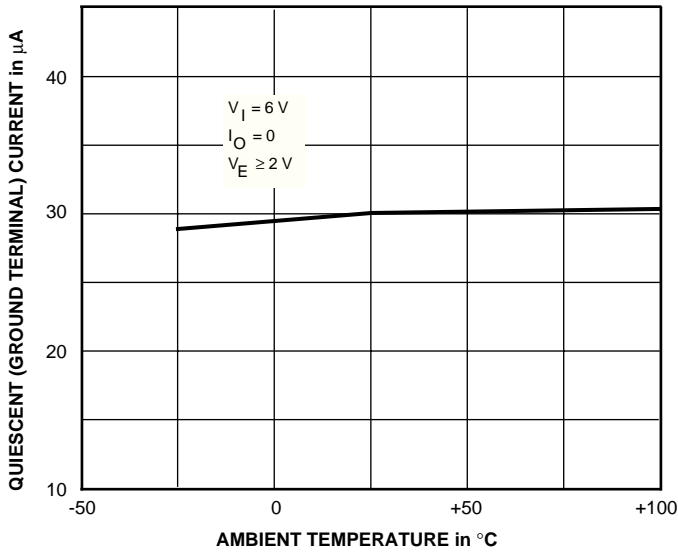

Dwg. GP-051-4

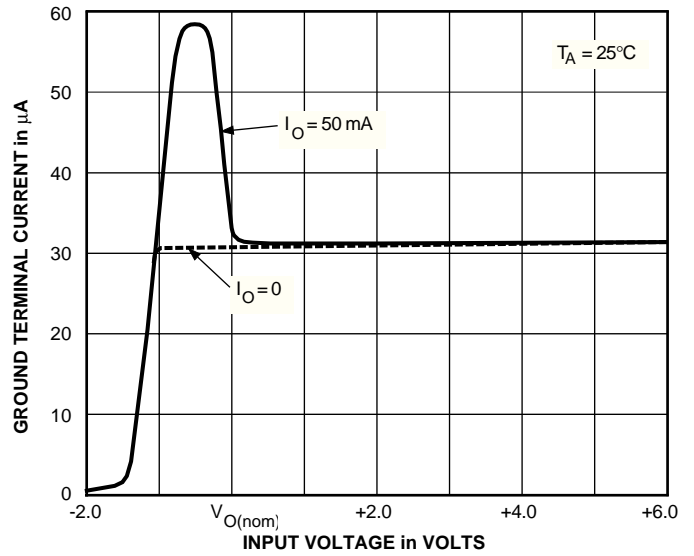

Dwg. GP-058-2

### DROPOUT VOLTAGE

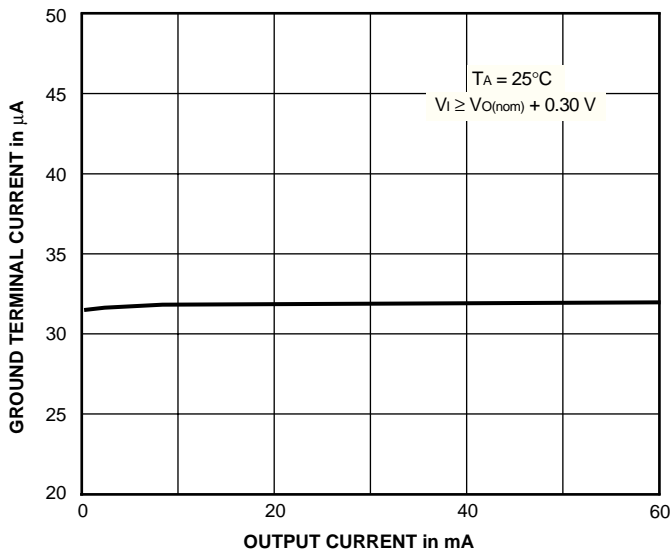

Dwg. GP-071

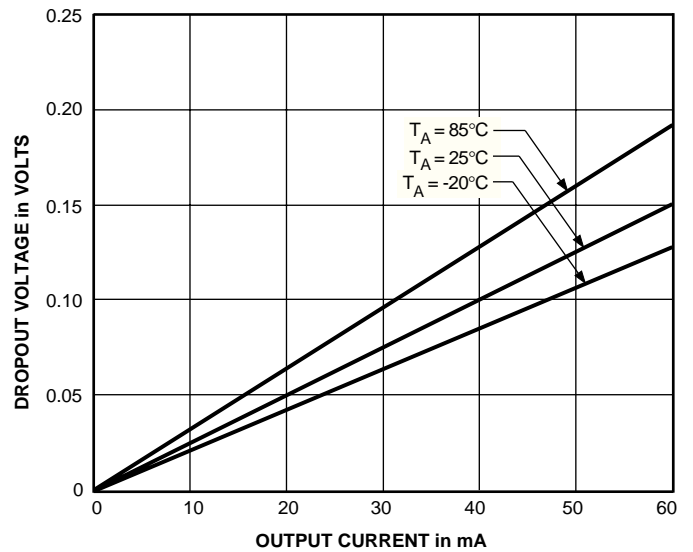

Dwg. GP-054-3

**CAUTION:** Maximum allowable duty cycle will be significantly less than 100% at high temperatures, at high input voltages, or at high output currents. See appropriate Maximum Allowable Output Current table.

# 8220 THRU 8233 LOW-DROPOUT REGULATORS

## TYPICAL CHARACTERISTICS (concluded)

### LOAD TRANSIENT PERFORMANCE

$V_I = 3.2\text{ V to }6.2\text{ V}$ ,  $C_O = 4.7\text{ }\mu\text{F}$ ,  $T_A = 25^\circ\text{C}$

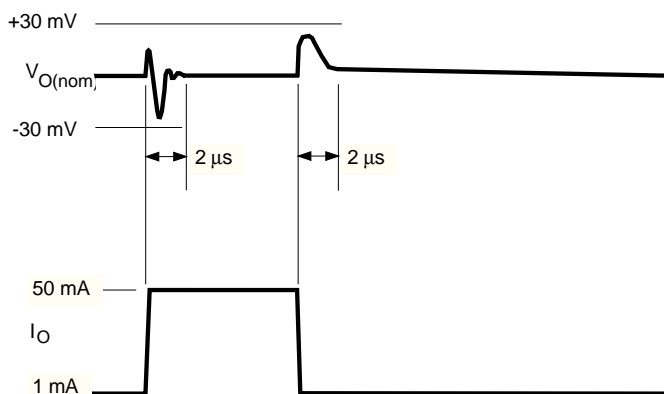

Dwg. WP-028-3

### ENABLE TRANSIENT PERFORMANCE

$V_I = 3.2\text{ V to }6.2\text{ V}$ ,  $C_O = 1\text{ }\mu\text{F}$ ,  $T_A = 25^\circ\text{C}$

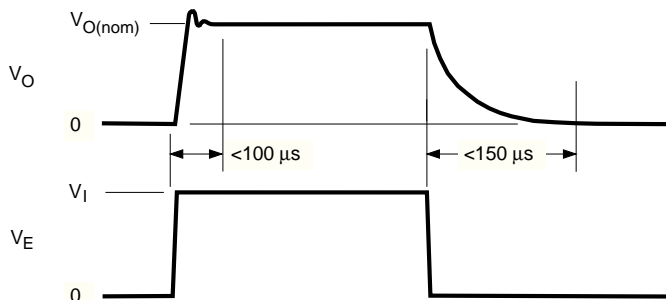

Dwg. WP-027-3

## APPLICATIONS INFORMATION

Linear regulators require input and output capacitors in order to maintain over-all loop stability. The recommended minimum value for the input capacitor is 0.1  $\mu\text{F}$ . The output capacitor is the dominant pole that provides the high-frequency compensation required for over-all regulator loop stability. These devices are stable with as little as 1  $\mu\text{F}$ . However, to ensure stable operation under all conditions and capacitor types, the recommended minimum value is 4.7  $\mu\text{F}$ . The output capacitor may be partially distributed through the load circuits. However, at least 1  $\mu\text{F}$  should be connected at the regulator using the shortest and widest foil pattern possible.

### Thermal Considerations

These devices are intended to provide up to 100 mA of load current in a very small package. The table on page 2 of this data sheet gives the maximum allowable average output current for a worst-case printed circuit design ( $R_{\theta JA} = 220^\circ\text{C/W}$  with a minimum footprint). Performance improvement is easily accomplished with the addition of 1 square inch of copper at terminal 2 ( $R_{\theta JA} = 170^\circ\text{C/W}$ ).

# 8220 THRU 8233 LOW-DROPOUT REGULATORS

## Dimensions in Inches

(for reference only)

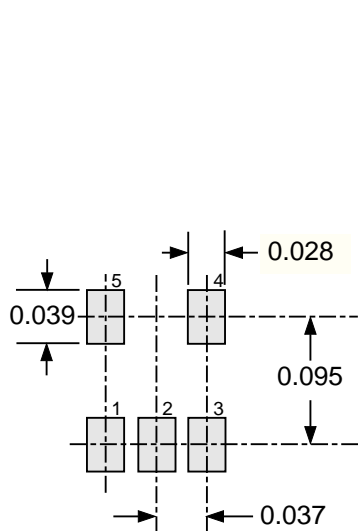

Dwg. MA-011-5 in

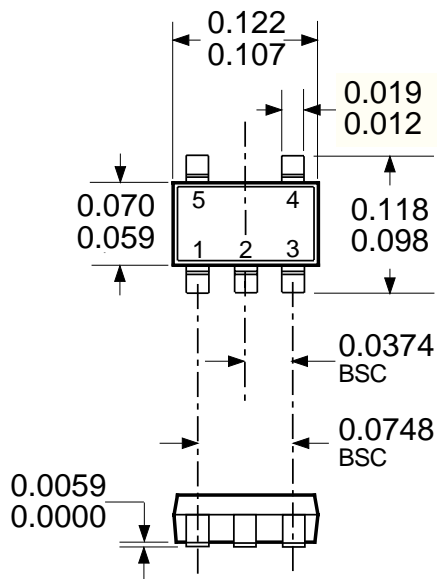

Dwg. MA-010-5 in

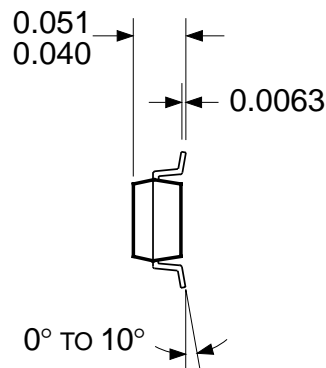

## Dimensions in Millimeters

(controlling dimensions)

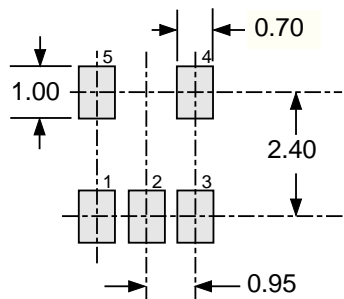

Dwg. MA-011-5 mm

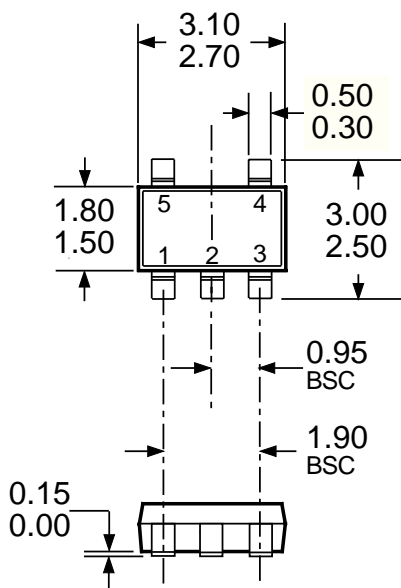

Dwg. MA-010-5 mm

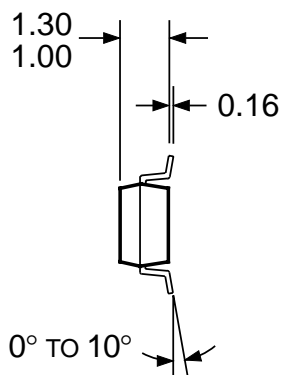

Allegro MicroSystems, Inc. reserves the right to make, from time to time, such departures from the detail specifications as may be required to permit improvements in the design of its products.

The information included herein is believed to be accurate and reliable. However, Allegro MicroSystems, Inc. assumes no responsibility for its use; nor for any infringements of patents or other rights of third parties which may result from its use.

NOTE: Exact body and lead configuration at vendor's option within limits shown.