

## 1 A, Low-Dropout, Dual Output, 2.5 V & 3.3 V Regulator

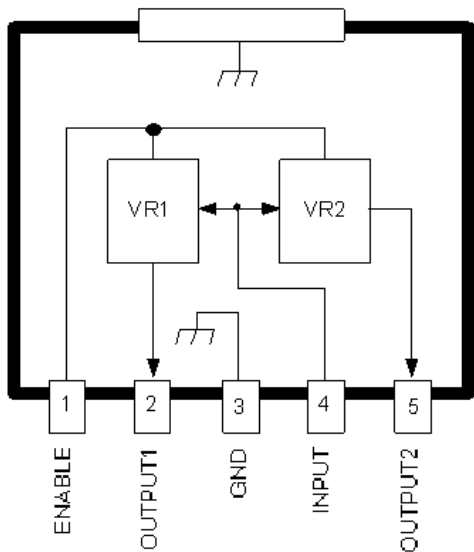

Dwg.PS-023-1

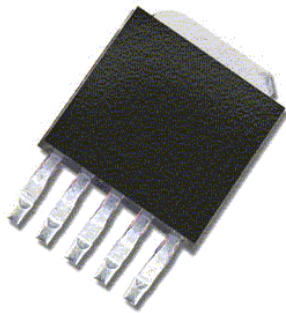

### ABSOLUTE MAXIMUM RATINGS

Input Voltage, $V_I$ .....	18 V
Output Current, $I_O$ .....	1 A*
Enable Input Voltage, $V_E$ .....	6.0 V
Junction Temperature, $T_J$ .....	+125°C
Storage Temperature Range, $T_S$ .....	-40°C to +125°C

\* Output current rating is limited by input voltage, duty cycle, and ambient temperature. Under any set of conditions, do not exceed a junction temperature of +125°C.

Designed to meet the high-current requirements in industrial and consumer applications; embedded core, memory, or logic supplies; TVs, VCRs, and office equipment, the SI-3002KWM voltage regulator offers the reduced dropout voltage and low quiescent current essential for improved efficiency. This device delivers dual regulated outputs at up to 1 A. Integrated thermal and overcurrent protection enhance overall system reliability. Devices with other output voltages are also available.

Quiescent current does not increase significantly as the dropout voltage is approached, an ideal feature in standby/resume power systems where data integrity is crucial. Regulator accuracy and excellent temperature characteristics are provided by a bandgap reference. An LS-TTL/CMOS-compatible input gives the designer complete control over power up, standby, or power down. A pnp pass element provides a dropout voltage of less than 600 mV at 1 A of load current. Low output voltages eliminate the need for expensive PWM buck converters. The low dropout voltage permits more efficient regulation before output regulation is lost.

This device is supplied in a 5-lead TO-252 style surface-mount plastic package with ground tab to provide a low-resistance path for maximum heat dissipation.

### FEATURES

- 1 A Output Current per Channel
- 0.6 V Maximum Dropout Voltage at  $I_O = 1$  A
- Fast Transient Response
- 1.5 mA Maximum Standby Current
- Foldback Current Limiting
- Ground Tab for Superior Heat Dissipation
- Thermal Protection

### APPLICATIONS

- TVs, VCRs, Electronic Games
- Embedded Core, Memory, or Logic Supplies
- Printers and Other Office Equipment
- Industrial Machinery
- Secondary-Side Stabilization of Multi-Output SMPS

Always order by complete part number, e.g., **SI-3002KWM-TL**, where "-TL" indicates tape and reel.

**SI-3002KWM**  
**1 A, Low-Dropout,**  
**Dual Output,**  
**2.5 V & 3.3 V Regulator**

*Linear  
Regulators*

**FUNCTIONAL BLOCK DIAGRAM**

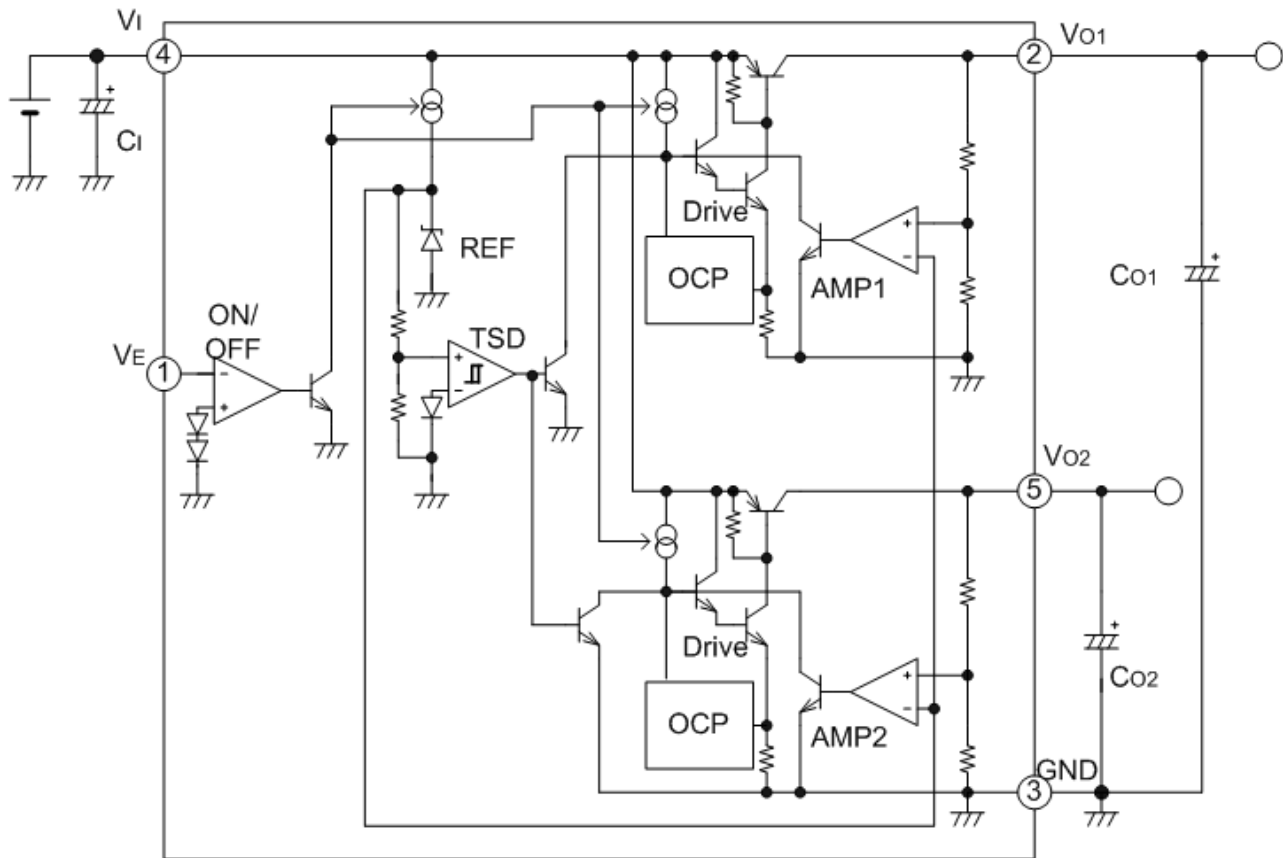

**Allowable Package Power Dissipation**

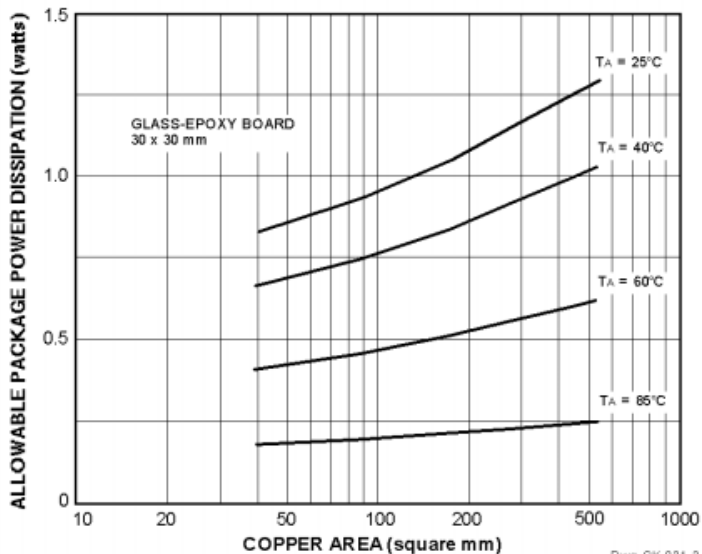

**Recommended Operating Conditions**

	Min	Max	Units
DC Output Current	0	1	A
Operating Ambient Temp.	-30	+85	°C
Operating Junction Temp.	-20	+100	°C

For the availability of parts meeting -40°C requirements, contact Allegro's Sales Representative.

This data sheet is based on Sanken data sheet SSJ-02236

**ELECTRICAL CHARACTERISTICS** at  $T_A = +25^\circ\text{C}$ ,  $V_E = 2\text{ V}$  (unless otherwise noted).

Characteristic	Symbol	Test Conditions	Limits			
			Min.	Typ.	Max.	Units
<b>Channel 1</b>						
Output Voltage	$V_{O1}$	$V_I = 5.0\text{ V}, I_{O1} = 10\text{ mA}$	3.234	3.300	3.366	V
	$V_{O1(\text{off})}$	$V_E = 0\text{ V}$	—	—	0.5	V
Output Volt. Temp. Coeff.	$a_{VO1}$	$0^\circ\text{C} \leq T_J \leq 100^\circ\text{C}$	—	$\pm 0.3$	—	mV/°C
Output Short-Circuit Current	$I_{OM1}$	$V_I = 5.0\text{ V}$ , See note	1.2	—	—	A
Line Regulation	$\Delta V_{O(\Delta V)1}$	$V_I = 4.5\text{ V} \sim 10\text{ V}, I_{O1} = 10\text{ mA}$	—	—	20	mV
Load Regulation	$\Delta V_{O(\Delta I)1}$	$V_I = 5.0\text{ V}, I_{O1} = 0\text{ A} \sim 1.0\text{ A}$	—	—	30	mV
Dropout Voltage	$V_{I\text{min}} - V_{O1}$	$I_{O1} = 1.0\text{ A}$	—	—	0.6	V
Ripple Rejection Ratio	PSRR	$V_I = 5.0\text{ V}, 100\text{ Hz} \leq f \leq 120\text{ Hz}$	—	60	—	dB
<b>Channel 2</b>						
Output Voltage	$V_{O2}$	$V_I = 5.0\text{ V}, I_{O2} = 10\text{ mA}$	2.450	2.500	2.550	V
	$V_{O2(\text{off})}$	$V_E = 0\text{ V}$	—	—	0.5	V
Output Volt. Temp. Coeff.	$a_{VO2}$	$0^\circ\text{C} \leq T_J \leq 100^\circ\text{C}$	—	$\pm 0.3$	—	mV/°C
Output Short-Circuit Current	$I_{OM2}$	$V_I = 5.0\text{ V}$ , See note	1.2	—	—	A
Line Regulation	$\Delta V_{O(\Delta V)2}$	$V_I = 4.5\text{ V} \sim 10\text{ V}, I_{O2} = 10\text{ mA}$	—	—	20	mV
Load Regulation	$\Delta V_{O(\Delta I)2}$	$V_I = 5.0\text{ V}, I_{O2} = 0\text{ A} \sim 1.0\text{ A}$	—	—	30	mV
Dropout Voltage	$V_{I\text{min}} - V_{O2}$	$I_{O2} = 1.0\text{ A}$	—	—	0.6	V
Ripple Rejection Ratio	PSRR	$V_I = 5.0\text{ V}, 100\text{ Hz} \leq f \leq 120\text{ Hz}$	—	60	—	dB
<b>Logic</b>						
Ground Terminal Current	$I_{\text{GND}}$	$V_I = 5.0\text{ V}, I_O = 0\text{ mA}, V_E = 2.0\text{ V}$	—	1.0	1.5	mA
		$V_I = 5.0\text{ V}, V_E = 0\text{ V}$	—	—	0.5	mA
Enable Input Voltage	$V_{\text{EH}}$	Output ON	2.0	—	—	V
	$V_{\text{EL}}$	Output OFF	—	—	0.8	V
Enable Input Current	$I_{\text{EH}}$	$V_E = 2.7\text{ V}$	—	0	5.0	$\mu\text{A}$
	$I_{\text{EL}}$	$V_E = 0.4\text{ V}$	—	-12	-100	$\mu\text{A}$
Thermal Shutdown	$T_J$	$I_O = 10\text{ mA}$	135	150	—	°C

Typical values are given for circuit design information only.

Note: Output short-circuit current is at point where output voltage has decreased 5%.

**SI-3002KWM**  
**1 A, Low-Dropout,**  
**Dual Output,**  
**2.5 V & 3.3 V Regulator**

**Linear  
Regulators**

**TYPICAL CHARACTERISTICS**

( $V_I = 5.0\text{ V}$ ,  $T_A = 25^\circ\text{C}$ )

■ Chan. 1 Dropout Voltage

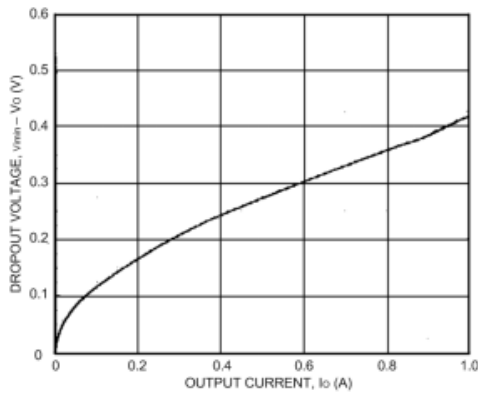

■ Chan. 1 Low-Voltage Behavior

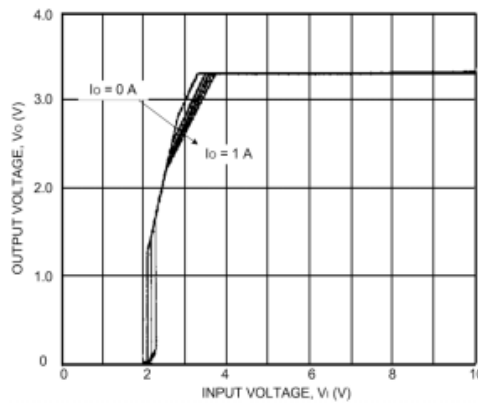

■ Chan. 1 Overcurrent Protection

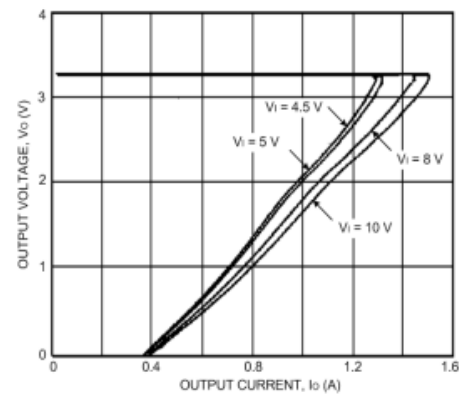

■ Chan. 1 Line Regulation

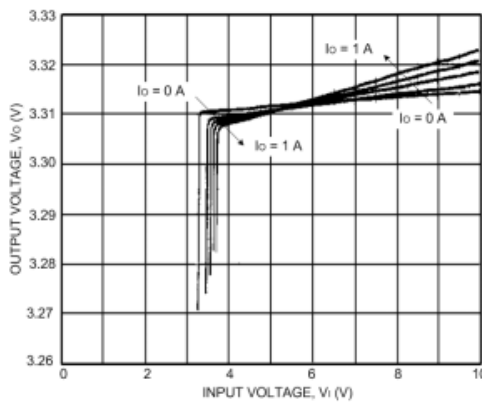

■ Chan. 1 Load Regulation

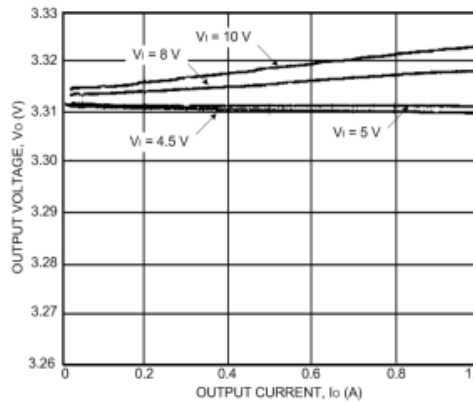

■ Chan. 1 Transient Response

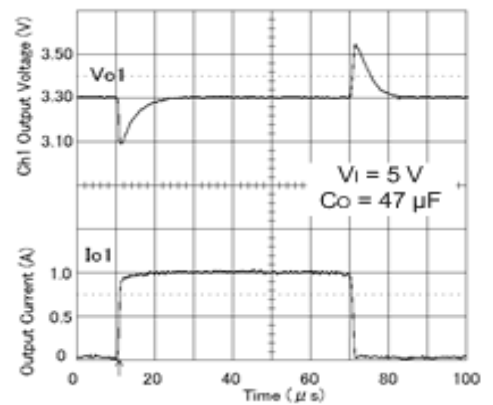

### TYPICAL CHARACTERISTICS (cont.)

( $V_I = 5.0\text{ V}$ ,  $T_A = 25^\circ\text{C}$ )

■ Chan. 2 Low-Voltage Behavior

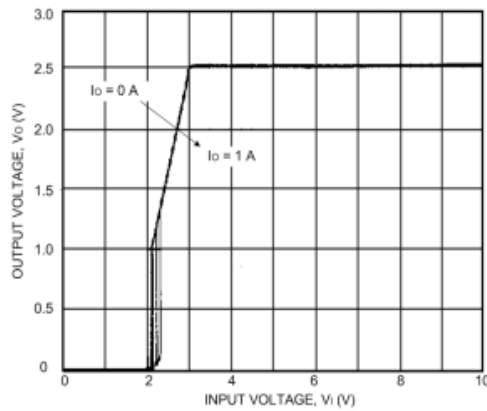

■ Chan. 2 Overcurrent Protection

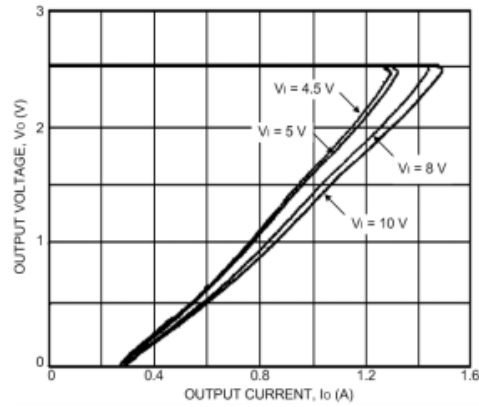

■ Chan. 2 Line Regulation

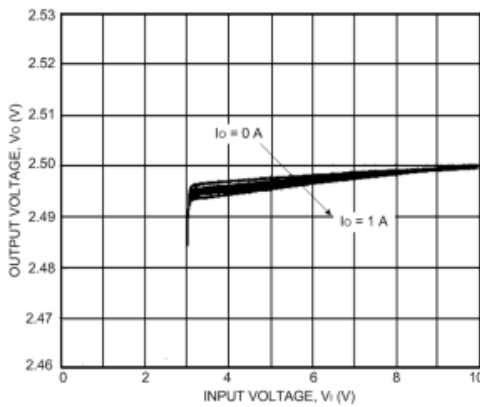

■ Chan. 2 Load Regulation

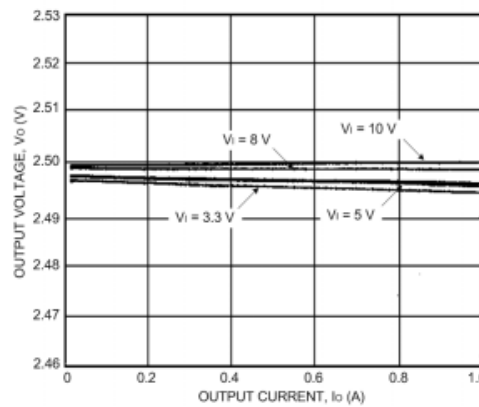

■ Chan. 2 Transient Response

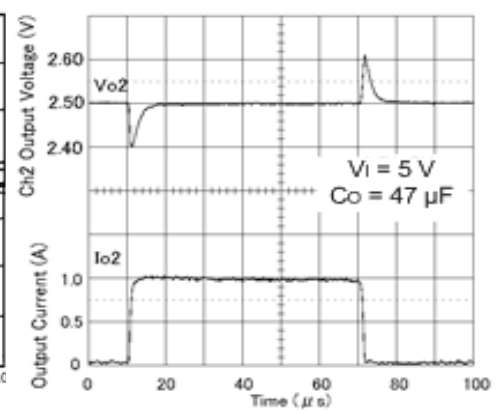

■ ENABLE Control Voltage

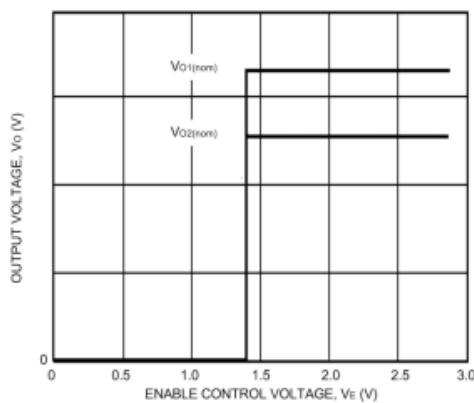

■ ENABLE Control Current

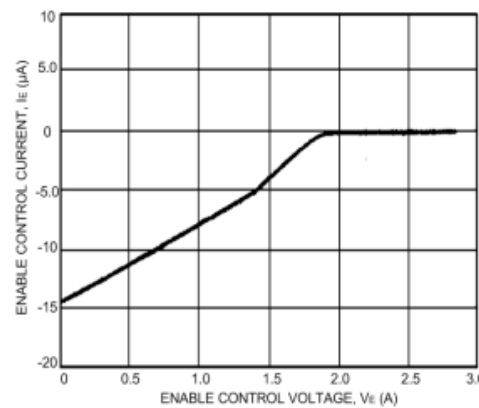

■ Thermal Protection

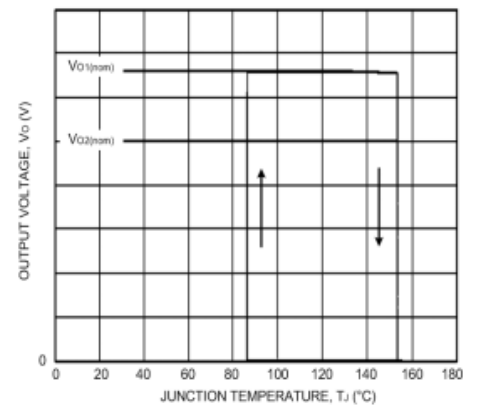

**SI-3002KWM**  
**1 A, Low-Dropout,**  
**Dual Output,**  
**2.5 V & 3.3 V Regulator**

**Linear  
Regulators**

**APPLICATIONS INFORMATION**

**Input Capacitor** ( $C_I$ , 0.1 ~ 10  $\mu$ F). This is necessary either when the input line includes inductance or when the wiring is long.

**Output Capacitor** ( $C_O$ , >22  $\mu$ F). This device is not designed for a use with a very low ESR output capacitor such as a ceramic capacitor. Output oscillation may occur with that kind of capacitor.

**ENABLE Input.** The ENABLE (control) input features an internal pull-up resistor. Leaving this input open causes the output to turn on.

**Parallel Operation.** Parallel operation to increase load current is not permitted.

**Determination of DC Input Voltage.** The minimum input voltage  $V_I(\text{min})$  should be higher than the sum of the fixed output voltage and the maximum rated dropout voltage.

**Overcurrent Protection.** The SI-3000KWM series has a built-in fold-back type overcurrent protection circuit, which limits the output current at a start-up mode. It thus cannot be used in applications that require current at the start-up mode such as:

- (1) constant-current load,
- (2) power supply with positive and negative outputs to common load (a center-tap type power supply), or
- (3) raising the output voltage by putting a diode or a resistor between the device ground and system ground.

**Thermal Protection.** Circuitry turns off the pass transistor when the junction temperature rises above 135°C. It is intended only to protect the device from failures due to excessive junction temperatures and should not imply that output short circuits or continuous overloads are permitted.

**Heat Radiation and Reliability.** The reliability of the IC is directly related to the junction temperature ( $T_J$ ) in its operation. Accordingly, careful consideration should be given to heat dissipation.

The inner frame on which the integrated circuit is mounted is connected to the GND terminal (pin 3). Therefore, it is very effective for heat radiation to enlarge the copper area that is connected to the GND terminal. The graph illustrates the effect of the copper area on the junction-to-ambient thermal resistance ( $R_{\theta JA}$ ).

The junction temperature ( $T_J$ ) can be determined from either of the following equations:

$$T_J = (P_D \times R_{\theta JA}) + T_A$$

or

$$T_J = (P_D \times R_{\theta JT}) + T_T$$

where  $P_D = I_{O1}(V_I - V_{O1}) + I_{O2}(V_I - V_{O2})$  and  $R_{\theta JT} = 6^\circ\text{C/W}$ .

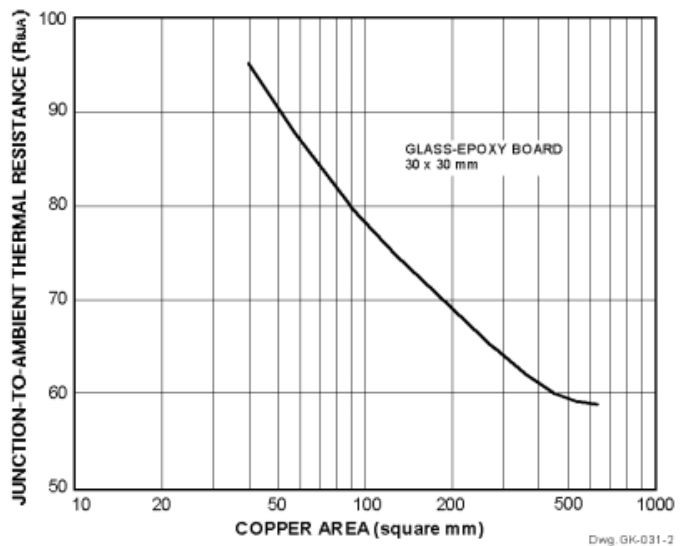

**Dimensions in Millimeters**



**Recommended Land Pattern**

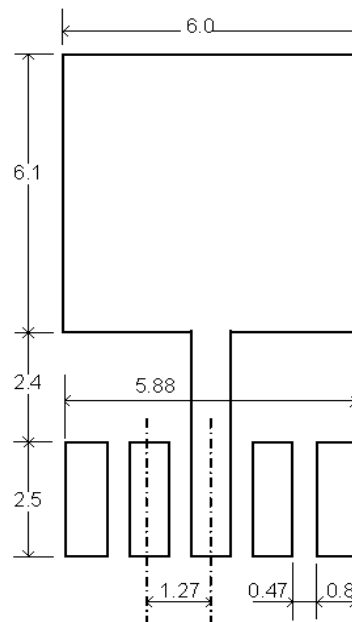

Terminal Finish: Pure Sn, 2<sup>nd</sup> level interconnect category (e3)

Product Weight: Approx. 0.33 g

3000 pieces per reel.

**SI-3002KWM**  
**1 A, Low-Dropout,**  
**Dual Output,**  
**2.5 V & 3.3 V Regulator**

**Linear  
Regulators**

**Tape and Reel Dimensions in Millimeters**

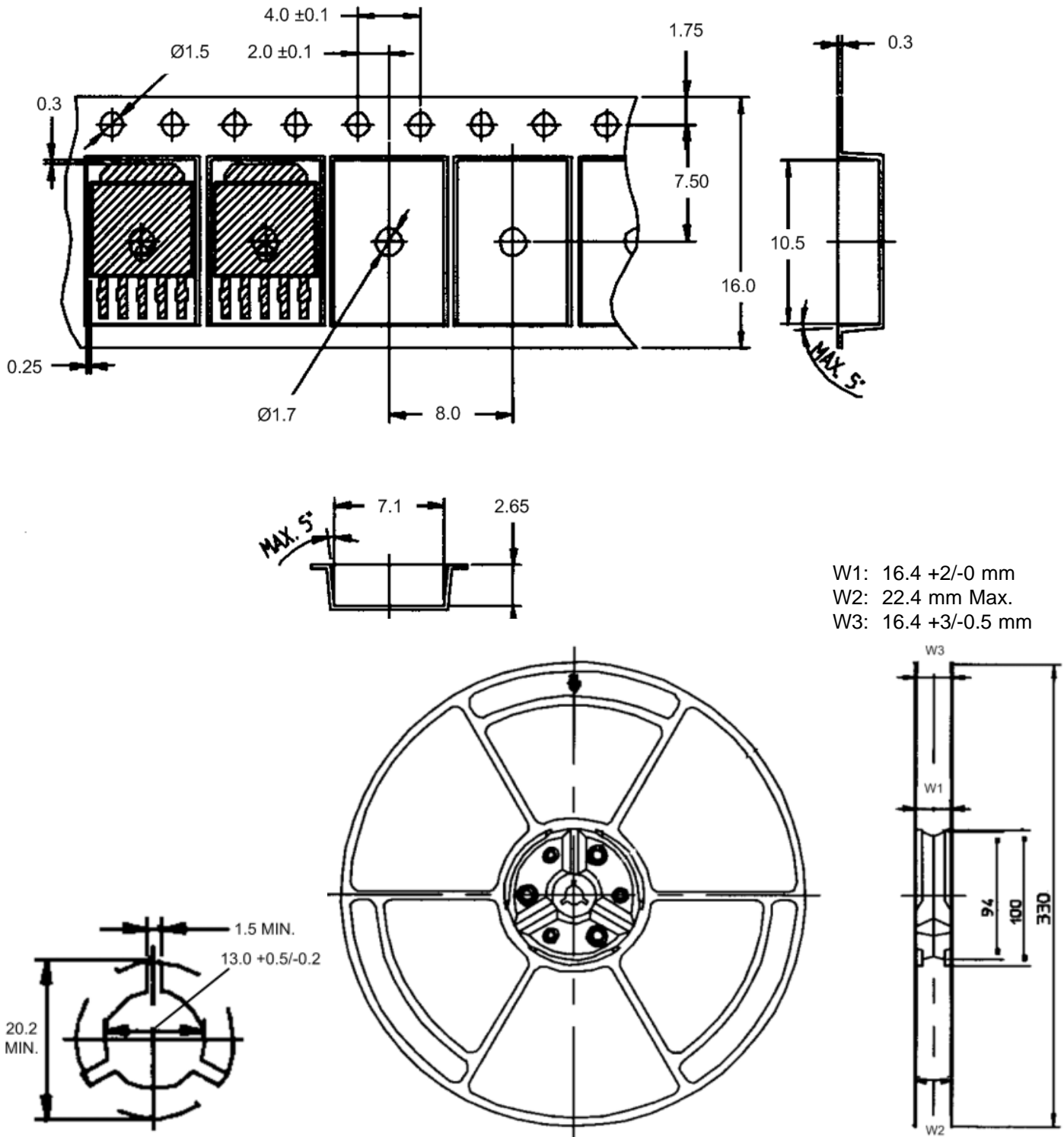



*The products described herein are manufactured in Japan by Sanken Electric Co., Ltd. for sale by Allegro MicroSystems, Inc.*

*Sanken and Allegro reserve the right to make, from time to time, such departures from the detail specifications as may be required to permit improvements in the performance, reliability, or manufacturability of its products. Therefore, the user is cautioned to verify that the information in this publication is current before placing any order.*

*When using the products described herein, the applicability and suitability of such products for the intended purpose shall be reviewed at the users responsibility.*

*Although Sanken undertakes to enhance the quality and reliability of its products, the occurrence of failure and defect of semiconductor products at a certain rate is inevitable.*

*Users of Sanken products are requested to take, at their own risk, preventative measures including safety design of the equipment or systems against any possible injury, death, fires or damages to society due to device failure or malfunction.*

*Sanken products listed in this publication are designed and intended for use as components in general-purpose electronic equipment or apparatus (home appliances, office equipment, telecommunication equipment, measuring equipment, etc.). Their use in any application requiring radiation hardness assurance (e.g., aerospace equipment) is not supported.*

*When considering the use of Sanken products in applications where higher reliability is required (transportation equipment and its control systems or equipment, fire- or burglar-alarm systems, various safety devices, etc.), contact a company sales representative to discuss and obtain written confirmation of your specifications.*

*The use of Sanken products without the written consent of Sanken in applications where extremely high reliability is required (aerospace equipment, nuclear power-control stations, life-support systems, etc.) is strictly prohibited.*

*The information included herein is believed to be accurate and reliable. Application and operation examples described in this publication are given for reference only and Sanken and Allegro assume no responsibility for any infringement of industrial property rights, intellectual property rights, or any other rights of Sanken or Allegro or any third party that may result from its use.*