

## All-Band AM/FM Receiver and Audio Amplifier

### Description

The U2510B is an integrated bipolar one-chip AM/FM radio circuit. It contains an FM front end with preamplifier, FM IF and demodulator, a complete AM

receiver, an AF amplifier and a mode switch for AM, FM and tape. This circuit is designed for clock radios and portable radio-cassette recorders.

### Features

- Superior FM strong signal behavior by using RF AGC
- Soft mute and HCC for decreasing interstation noise in FM mode
- Excellent AFC performance (level controlled, both polarities available)
- Level indicator (LED drive) for AM and FM
- DC mode control: AM, FM and tape
- Wide supply-voltage range and low quiescent current
- High AF output power: 1 W
- Electronic volume control
- Electronic AF bandwidth control (treble and high cut)
- Output stage for headphone and speaker drive

### Block Diagram

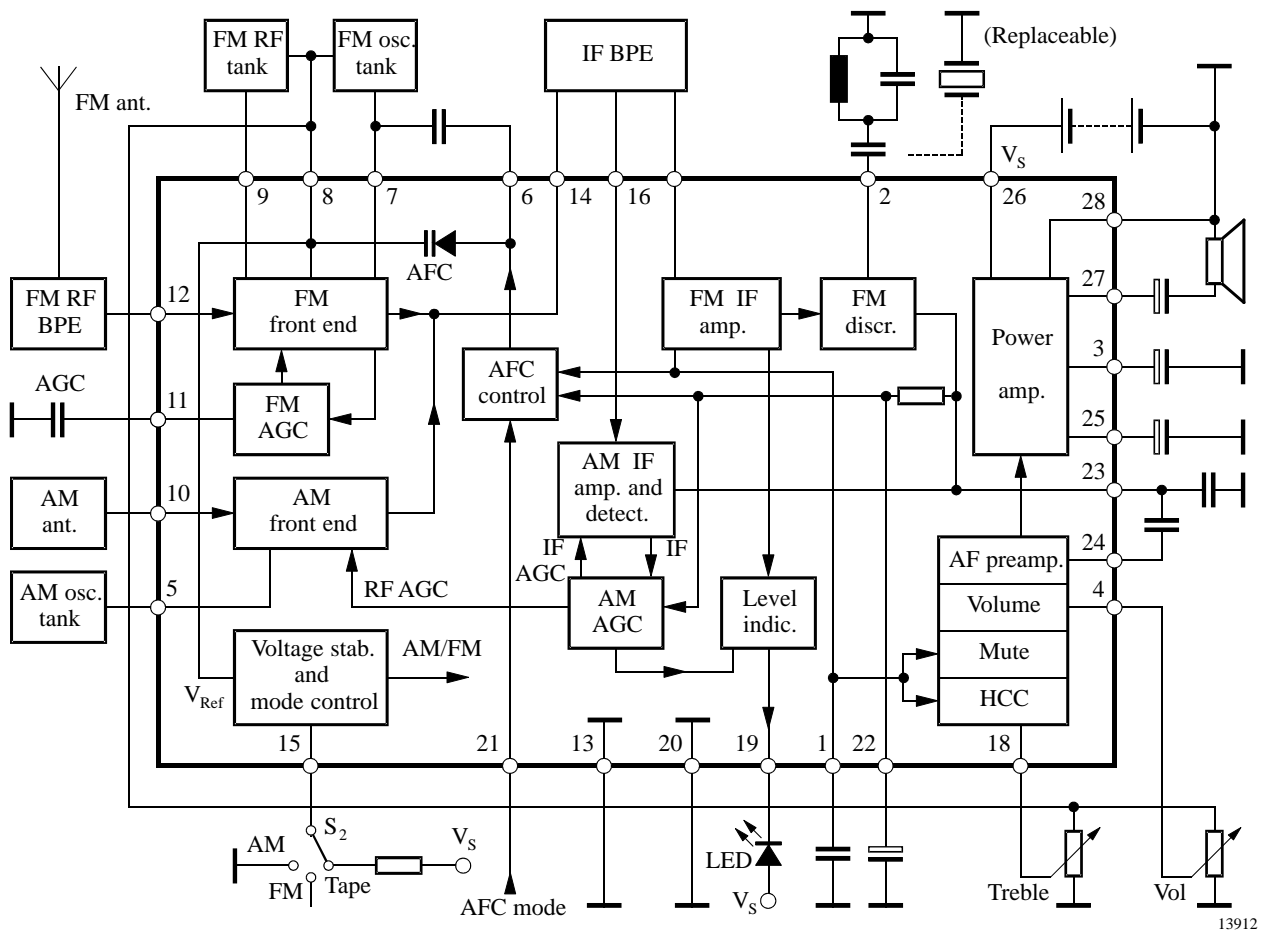

Figure 1. Block diagram

## Order Information

Extended Type Number	Package	Remarks
U2510B-M	SDIP28	
U2510B-M_T	SDIP28	$V_S < 6\text{ V}$ supply voltage

## Pin Description

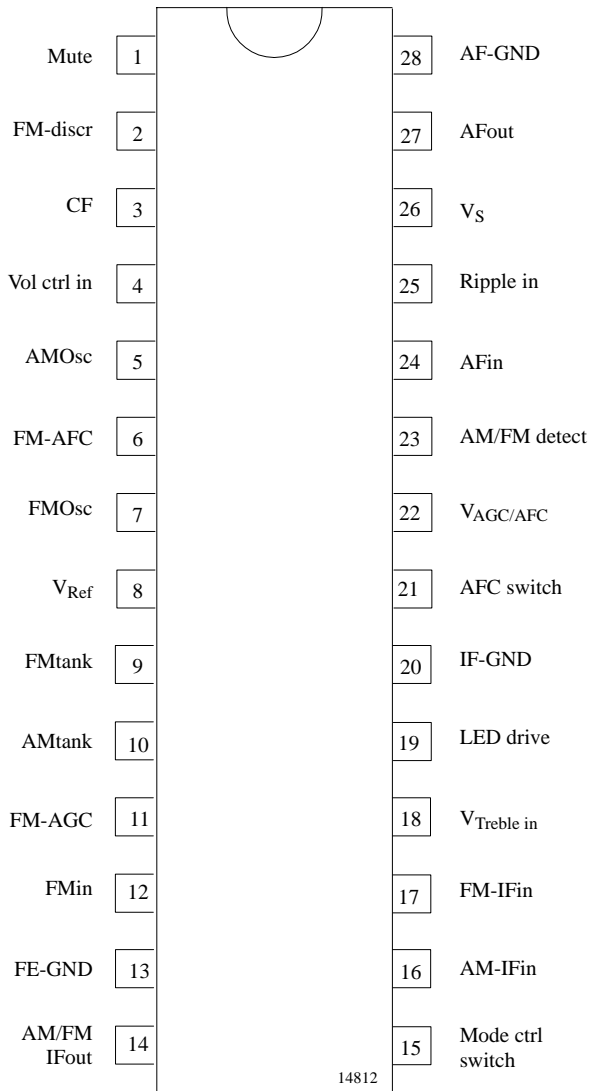

Figure 2. Pinning

Pin	Symbol	Function
1	Mute	Mute voltage output, time constant ( $C_{23}$ ), mute depth and threshold adjustable by load resistance ( $R_3$ )
2	FM-discr	FM discriminator filter connection, ceramic resonator or equivalent LC-circuit
3	CF	Audio negative feedback input. Blocking capacitor ( $C_8$ ) determines the audio amplifiers low-end cut-off frequency
4	Vol ctrl in	Input for volume control voltage

Pin	Symbol	Function								
5	AM Osc	AM oscillator tank circuit input, recommended load impedance approximately 2.5 k $\Omega$								
6	FM-AFC	AFC diode connection, coupling capacitor ( $C_{19}$ ) determines the AFC characteristic (holding range and slope)								
7	FMOsc	FM oscillator tank circuit input, recommended load impedance approximately 3 k $\Omega$								
8	$V_{Ref}$	Regulated voltage output (2.4 V)								
9	FMtank	FM RF tank circuit connection, recommended load impedance approximately 3 k $\Omega$								
10	AMtank	AM RF tank circuit connection, recommended load impedance approximately 20 k $\Omega$								
11	FM-AGC	FM AGC voltage output, time constant ( $C_{20}$ ). Loading this pin by a resistor (to GND) will increase the FM AGC threshold, grounding this pin will switch off the FM AGC function								
12	FMin	FM RF input (common-base preamplifier transistor), recommended (RF) source impedance approximately 100 $\Omega$								
13	FE-GND	FM front-end ground								
14	AM/FM IFout	AM/FM IF output (collector output of the IF preamplifier)								
15	Mode ctrl switch	Mode control input: <table border="1"> <thead> <tr> <th>Pin</th> <th>Function</th> </tr> </thead> <tbody> <tr> <td>open</td> <td>FM</td> </tr> <tr> <td>Ground</td> <td>AM</td> </tr> <tr> <td><math>V_S</math> (<math>R_4 = 10\text{ k}\Omega</math>)</td> <td>Tape</td> </tr> </tbody> </table>	Pin	Function	open	FM	Ground	AM	$V_S$ ( $R_4 = 10\text{ k}\Omega$ )	Tape
Pin	Function									
open	FM									
Ground	AM									
$V_S$ ( $R_4 = 10\text{ k}\Omega$ )	Tape									
16	AM-IFin	AM IF input, input impedance = 3.1 k $\Omega$								
17	FM-IFin	FM IF input, input impedance = 330 $\Omega$								
18	$V_{Treble\ in}$	Treble control voltage input								
19	LED drive	Level indicator output (open-collector output, LED drive)								
20	IF-GND	IF ground								
21	AFC switch	AFC function control input: <table border="1"> <thead> <tr> <th>Pin</th> <th>Function</th> </tr> </thead> <tbody> <tr> <td>open</td> <td>AFC off</td> </tr> <tr> <td>Ground</td> <td><math>f_{OSC} &gt; f_{in}</math></td> </tr> <tr> <td><math>V_S</math></td> <td><math>f_{OSC} &lt; f_{in}</math></td> </tr> </tbody> </table>	Pin	Function	open	AFC off	Ground	$f_{OSC} > f_{in}$	$V_S$	$f_{OSC} < f_{in}$
Pin	Function									
open	AFC off									
Ground	$f_{OSC} > f_{in}$									
$V_S$	$f_{OSC} < f_{in}$									
22	$V_{AGC/AFC}$	AGC/AFC voltage, time constant adjust ( $C_{10}$ ), input impedance approximately 42 k $\Omega$								
23	AM/FM detect	AM/FM detector output, the load capacitor ( $C_{11}$ ) in conjunction with the detector output resistance (7.5 k $\Omega$ ) determines the (FM) deemphasis as well as the (modulation) frequency response of the AM detector								
24	AFin	Audio amplifier input, input resistance approximately 100 k $\Omega$ , coupling capacitor ( $C_9$ ) determines the low frequency response								
25	Ripple in	Ripple filter connection. Load capacitance ( $C_{12}$ ) determines the frequency response of the supply-voltage ripple rejection								
26	$V_S$	Supply voltage input								
27	AFout	Audio amplifier output								
28	AF-GND	Ground of the audio power stage								

## Terminal Voltages

Test circuit:  $V_{in} = 0$

Pin		Symbol	Voltage/V					
			$V_S = 3\text{ V}$			$V_S = 6\text{ V}$		
			AM	FM	TAPE	AM	FM	TAPE
1	Mute voltage ( $R_3 = 0$ )	$V_1$	–	1.6	–	–	1.6	–
2	FM discriminator	$V_2$	–	1.0	–	–	1.0	–
3	Negative feedback	$V_3$	1.2	1.2	1.2	2.6	2.6	2.6
4	Volume control input ( $S_4 = A$ )	$V_4$	2.4	2.4	2.4	2.4	2.4	2.4
5	AM oscillator	$V_5$	2.4	–	–	2.4	–	–
6	FM AFC	$V_6$	–	1.9	–	–	1.9	–
7	FM oscillator	$V_7$	–	2.4	–	–	2.4	–
8	$V_{Ref}$	$V_8$	2.4	2.4	2.4	2.4	2.4	2.4
9	FM RF tank	$V_9$	–	2.4	2.4	–	2.4	–
10	AM input	$V_{10}$	2.4	–	–	–	2.4	–
11	FM AGC	$V_{11}$	–	0	–	–	0	–
12	FM input	$V_{12}$		1.4	–	–	1.4	–
13	Front end ground	$V_{13}$	–	–	–	–	–	–
14	AM/FM IF output	$V_{14}$	2.9	2.7	–	5.9	5.7	–
15	Mode control switch	$V_{15}$	0	–	2.9	0	–	5.7
16	AM IF input	$V_{16}$	0	–	–	0	–	–
17	FM IF input	$V_{17}$	–	0.7	–	–	0.7	–
18	Treble control input ( $S_5 = A$ )	$V_{18}$	2.4	2.4	2.4	2.4	2.4	2.4
19	LED	$V_{19}$						
20	IF ground	$V_{20}$	0	0	0	0	0	0
21	AFC switch ( $S_3 = \text{off}$ )	$V_{21}$	1.2	1.2	1.2	1.2	1.2	1.2
22	AGC (AM)/AFC (FM)	$V_{22}$	1.5	1.2	–	1.5	1.2	–
23	Detector output	$V_{23}$	1.5	1.2	–	1.5	1.2	–
24	AF input	$V_{24}$	1.5	1.5	1.5	1.5	1.5	1.5
25	Ripple filter	$V_{25}$	2.7	2.7	2.7	5.3	5.3	5.3
26	Supply voltage	$V_{26}$	3.0	3.0	3.0	6.0	6.0	6.0
27	AF output	$V_{27}$	1.2	1.2	1.2	2.6	2.6	2.6
28	AF ground	$V_{28}$	0	0	0	0	0	0

## Absolute Maximum Ratings

Parameters	Symbol	Value	Unit
Supply voltage	$V_S$	13	V
Power dissipation	$P_{tot}$	900	mW
Ambient temperature range	$T_{amb}$	-20 to +75	°C

## Electrical Characteristics

$V_S = 6\text{ V}$ ,  $T_{amb} = 25^\circ\text{C}$ , test circuit (figure 16), unless otherwise specified

Parameters	Test Conditions / Pins	Symbol	Min.	Typ.	Max.	Unit
Supply voltage range		$V_S$	2.5		9 *	V
Oscillator stop voltage		$V_S$	2.2			V
Operating temperature range		T	-20		+75	°C
Supply quiescent current	$V_{i1} = V_{i2} = V_4 = 0$ ; AM ( $S_2 = \text{AM}$ ) FM ( $S_2 = \text{FM}$ ) TAPE ( $S_2 = \text{Tape}$ )	$I_S$ $I_S$ $I_S$		4.0 6.5 2.2		mA mA mA
Regulated voltage	Pin 8	$V_{Ref}$		2.4		V
<b>Audio amplifier</b> $V_{i3}$ (Pin 24), test point: $V_o$ (Pin 27) $f = 1\text{ kHz}$ AF measuring range: 30 Hz to 20 kHz, $S_2 = \text{Tape}$ , $S_4 = \text{A}$ , $S_5 = \text{A}$						
Input resistance	Pin 24	$R_i$		100		k $\Omega$
Closed loop voltage gain	$GV_{af1} = 20 \log (V_o/V_{i3})$ $V_{i3} = 10\text{ mV}$	$GV_{af1}$		40		dB
Output voltage	$V_{i3} = 100\text{ mV}$ , $S_4 = \text{B}$	$V_o$		0.7	3	mV
High-end cut-off frequency	$f_c$ (-3 dB) $S_5 = \text{B}$	$f_c$ $f_c$		13 0.8		kHz kHz
Supply-voltage rejection ratio	$SVRR = 20 \log (V_{hum}/V_o)$ $V_{hum} = 200\text{ mV}$ , $f_{hum} = 200\text{ Hz}$ , $S_4 = \text{B}$	SVRR		32		dB
Noise voltage	$S_4 = \text{B}$ , $V_{i3} = 0$	$V_n$		300	1000	$\mu\text{V}$
AF output power	THD = 10 %, $R_L = 8\ \Omega$ $V_S = 4.5\text{ V}$ $V_S = 6.0\text{ V}$ $V_S = 9.0\text{ V}$	$P_o$ $P_o$ $P_o$	400	225 420 1000		mW mW mW
Distortion	$P_o = 50\text{ mW}$ , $R_L = 8\ \Omega$	d		0.6		%
<b>FM section</b> , $V_{i2} = 60\text{ dB}\mu\text{V}$ , $f_{i2} = 98\text{ MHz}$ , $f_m = 1\text{ kHz}$ , dev. = $\pm 22.5\text{ kHz}$ , $f_{iIF} = 10.7\text{ MHz}$ , AF measuring range: 300 Hz to 20 kHz, $S_2 = \text{FM}$ , $S_1 = \text{A}$ , $S_6 = \text{B}$ , test point: $V_D$ (Pin 23)						
FM front-end voltage gain	$GV_{FM} = 20 \log (V_{iIF} / V_{i2})$ $S_1 = \text{B}$ , $V_{i2} = 40\text{ dB}\mu\text{V}$	$GV_{FM}$		30		dB
Recovered audio voltage	Pin 23	$VD_{af}$		85		mV
Detector output resistance	Pin 23	$R_{Do}$		7.5		k $\Omega$
Detector output distortion	dev. = $\pm 75\text{ kHz}$ $V_{i2} = 60\text{ dB}\mu\text{V}$ $V_{i2} = 105\text{ dB}\mu\text{V}$	THD THD		0.5 0.8		% %

\* U2510B-M\_T: max. 6 V

## Electrical Characteristics (continued)

$V_S = 6\text{ V}$ ,  $T_{\text{amb}} = 25^\circ\text{C}$ , test circuit (figure 16), unless otherwise specified

Parameters	Test Conditions / Pins	Symbol	Min.	Typ.	Max.	Unit
AM rejection ratio	$m = 30\%$	$AM_{RR}$		25		dB
RF sensitivity	$(S+N)/N = 26\text{ dB}$	$V_{i2}$		9		dB $\mu\text{V}$
	$(S+N)/N = 46\text{ dB}$	$V_{i2}$		22		dB $\mu\text{V}$
Limiting threshold (-3 dB)		$V_{i2}$		3		dB $\mu\text{V}$
Mute voltage	Test point: Mute $V_{i2} = 0$	$V_{\text{mute}}$		1.8		V
	$V_{i2} = 60\text{ dB}\mu\text{V}$	$V_{\text{mute}}$		0.4		V
Mute depth	Referred to $V_0$ at $V_{i2} = 0$	MD		26		dB
	$S_6 = A$ $S_6 = C$	MD		20		dB
AFC holding range	$f_{\text{OSC}} > f_{\text{in}}$ , $S_3 = A$ , $S_6 = A$ $V_{i2} \leq 10\text{ dB}\mu\text{V}$ $V_{i2} = 20\text{ dB}\mu\text{V}$ $V_{i2} = 80\text{ dB}\mu\text{V}$	FHR FHR FHR		no AFC $\pm 180$ $\pm 220$		kHz kHz
LED current		$I_{\text{LED}}$		5.5		mA
Oscillator voltage	$eZ_{\text{load}} = 2.5\text{ k}\Omega$ Pin 7	$V_{\text{OSC}}$		180		mV
<b>AM section</b> $V_{i1} = 60\text{ dB}\mu\text{V}$ , $f_{i1} = 1.6\text{ MHz}$ , $f_m = 1\text{ kHz}$ , $m = 30\%$ , $f_{\text{iIF}} = 455\text{ kHz}$ , AF measuring range: 300 Hz to 20 kHz, ( $S_2 = \text{AM}$ , $S_1 = \text{B}$ , test point: $V_{\text{D}}$ )						
AM front end voltage gain	$GV_{\text{AM}} = 20 \log (V_{\text{iIF}}/V_{i1})$ $V_{i1} = 20\text{ dB}\mu\text{V}$ , $S_1 = A$	$GV_{\text{AM}}$		25		dB
Recovered audio voltage		$V_{\text{D af1}}$		70		mV
Detector output resistance	Pin 23	$R_{\text{Do}}$		7.5		k $\Omega$
Detector output distortion	$V_{i1} = 60\text{ dB}\mu\text{V}$	THD		1		%
	$V_{i1} = 105\text{ dB}\mu\text{V}$	THD		3		%
RF sensitivity	$(S+N)/N = 10\text{ dB}$	$V_{i1}$		0		dB $\mu\text{V}$
	$(S+N)/N = 26\text{ dB}$	$V_{i1}$		16		dB $\mu\text{V}$
	$(S+N)/N = 46\text{ dB}$	$V_{i1}$		35		dB $\mu\text{V}$
AGC figure of merit referred to $V_{\text{D af}}$	$V_{i1} = 105\text{ dB}\mu\text{V}$ , voltage drop ( $V_{\text{D af}}$ ) = -10 dB	FOM		100		dB
IF input resistance	Pin 16	$Z_i$		3.1		k $\Omega$
LED current		$I_{\text{LED}}$		5.5		mA
Oscillator voltage	Pin 5	$V_{\text{OSC}}$		160		mV

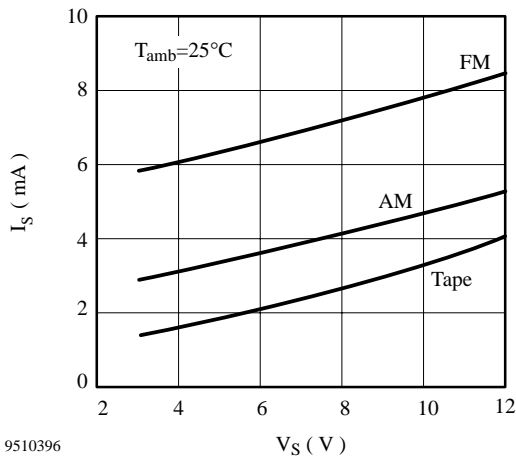

Figure 3. Quiescent current

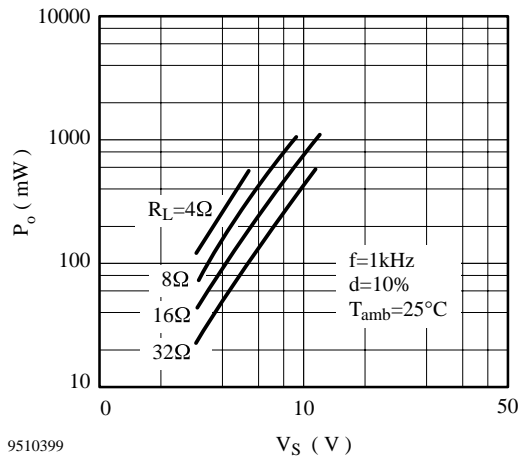

Figure 6. AF section: Max. output power

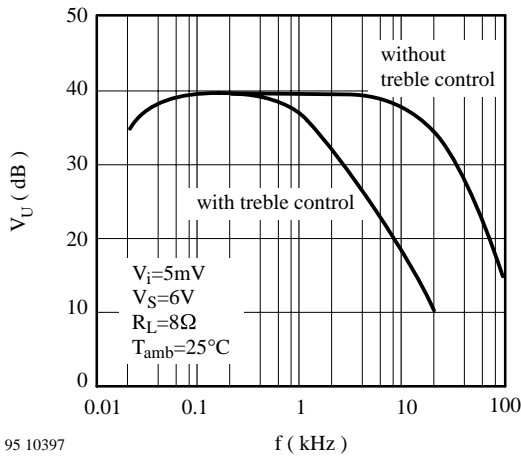

Figure 4. AF section

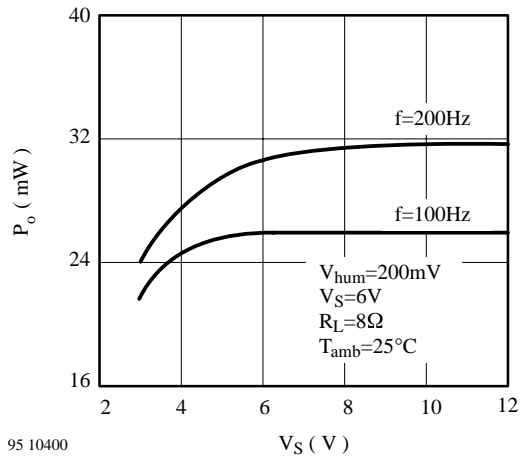

Figure 7. AF section: Supply-voltage rejection ratio

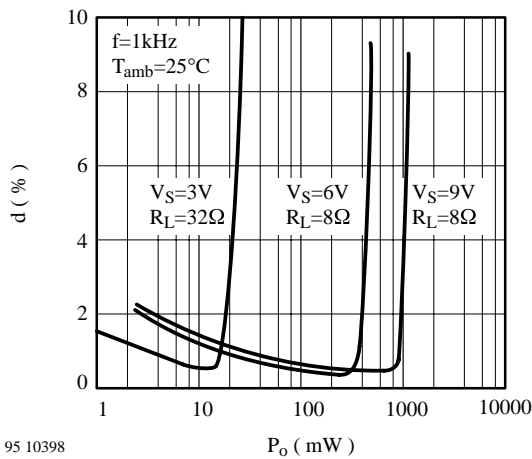

Figure 5. AF section: Distortion

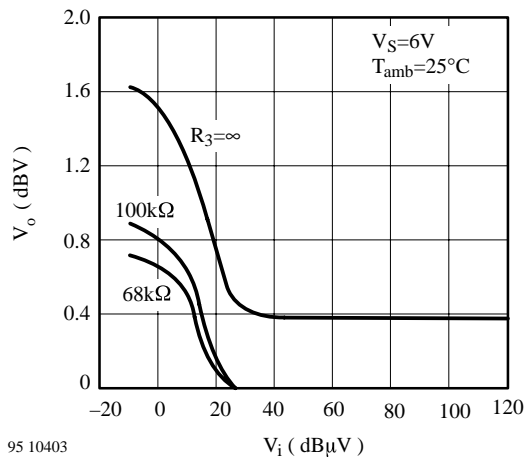

Figure 8. FM section: Mute voltage

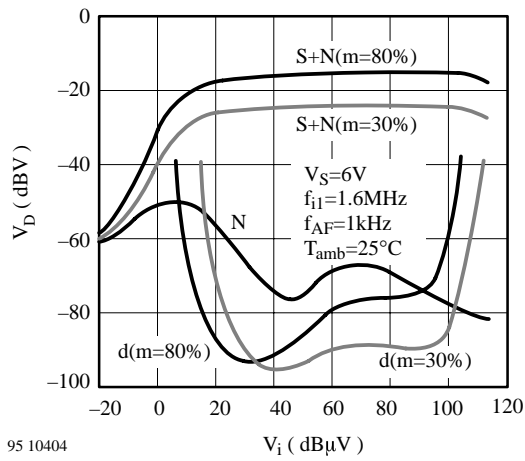

Figure 9. AM section: Demodulator output level

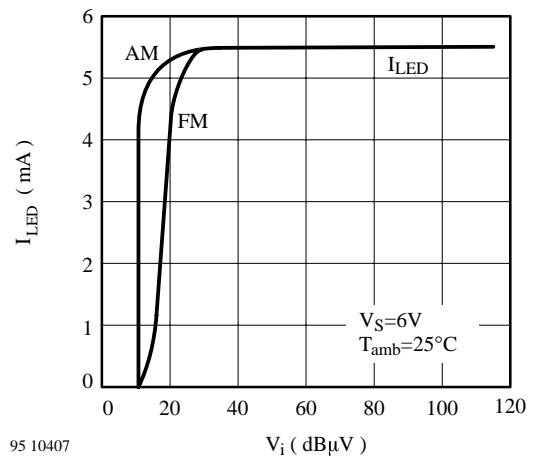

Figure 11. AM/FM level indicator current

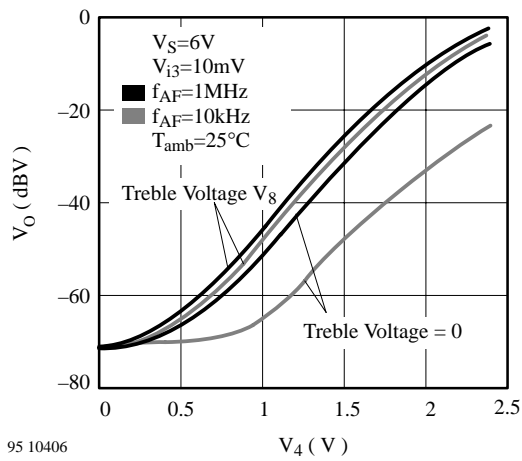

Figure 10. Volume control range characteristics

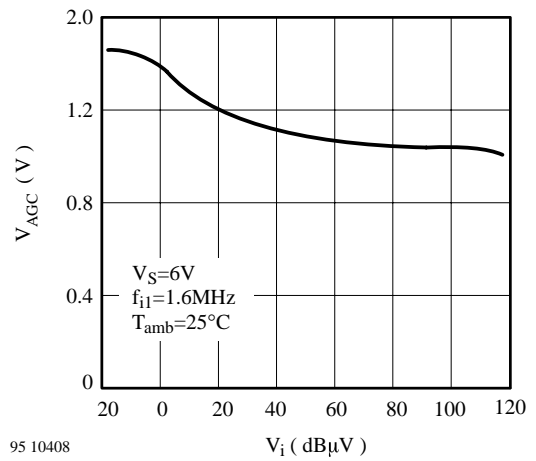

Figure 12. AM section: AGC voltage (at Pin 22)

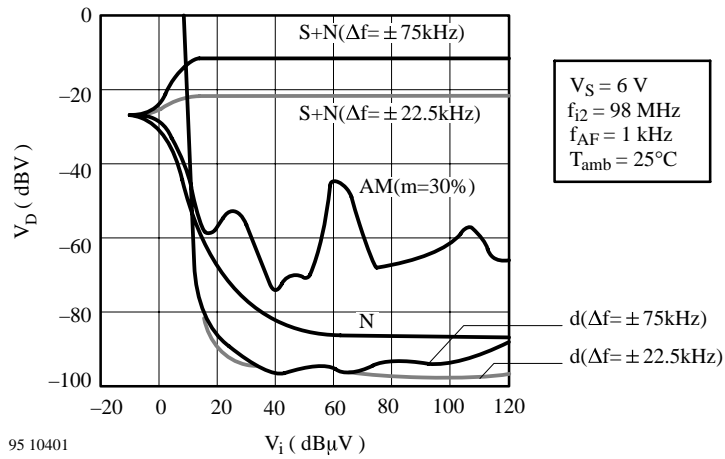

Figure 13. FM section: Demodulator output level

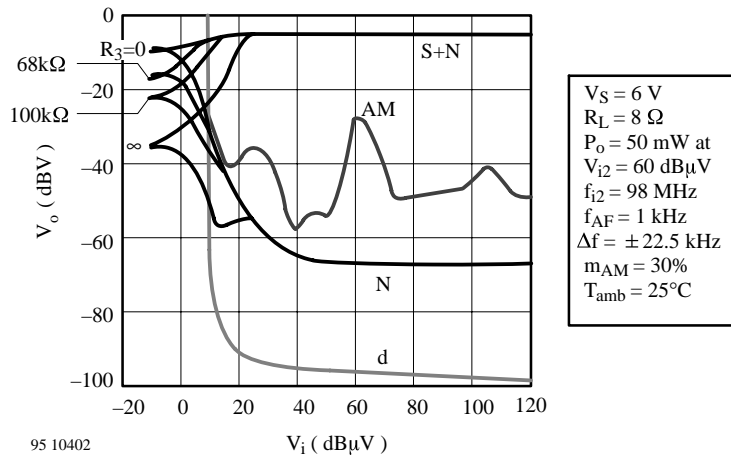

Figure 14. FM section: Audio output level

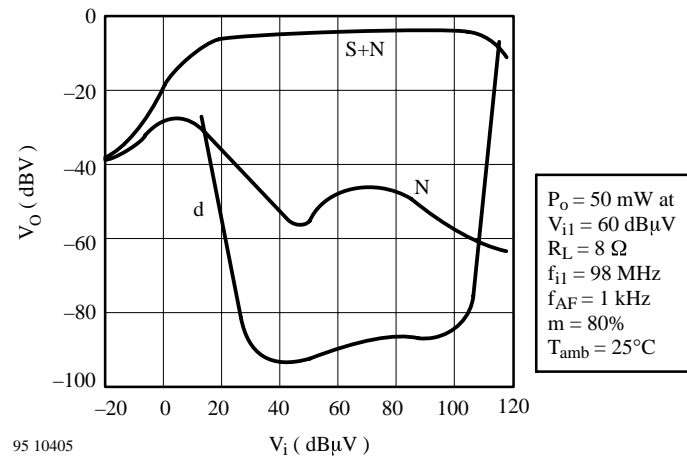

Figure 15. AM section: Audio output level



## Test Circuit

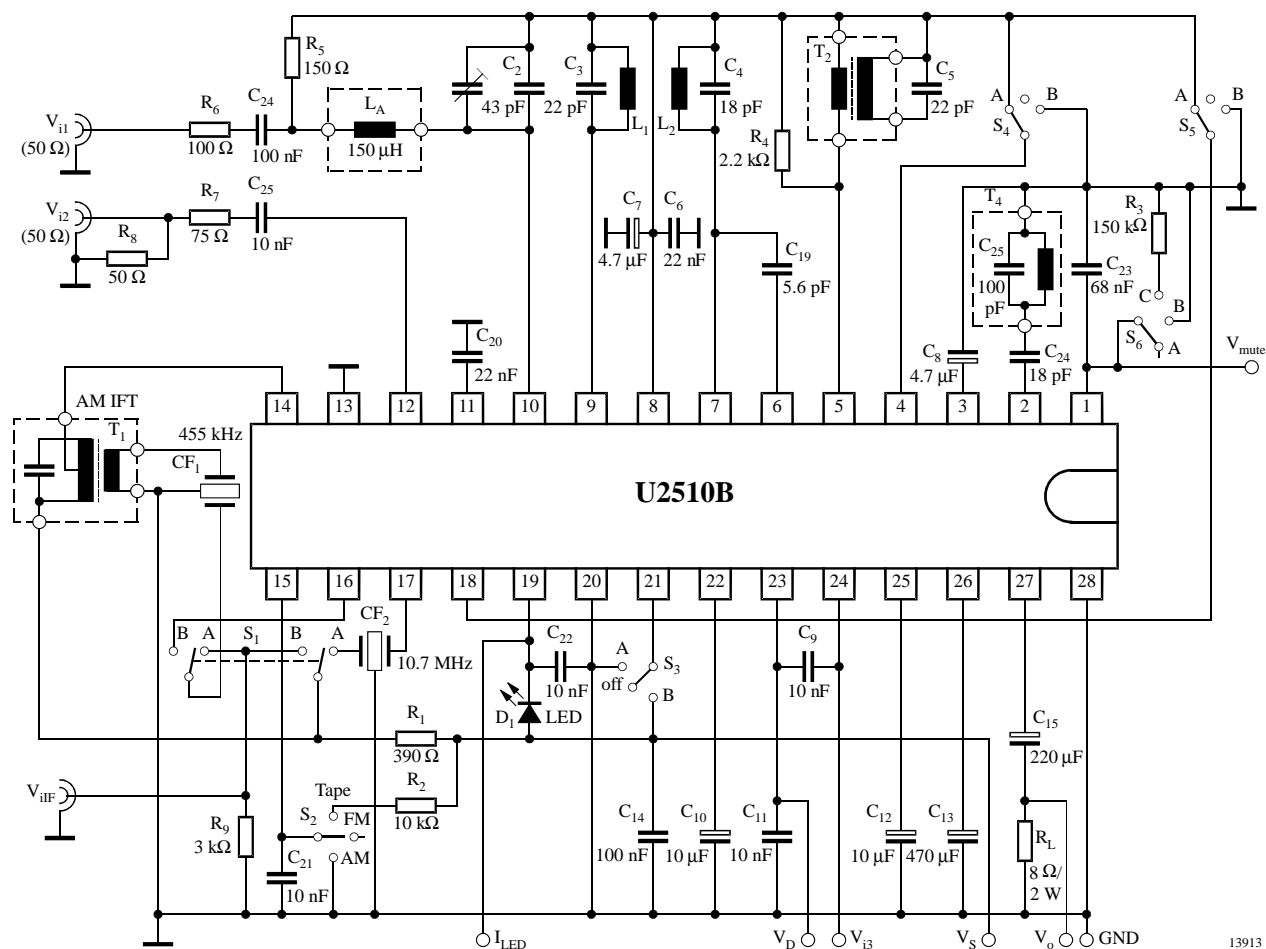

Figure 16. Test circuit

## Application

### General

The U2510B is a bipolar monolithic IC for use in radio sets, for example, headphone receivers, radio recorders and clock radios. The IC contains all AM, FM, AF and switching function blocks necessary to construct these kinds of radio receivers using only few components around the IC. In the design, special efforts were made to get good performance for all AM bands (short and long wave).

The implementation of enhanced functions (options) makes it possible to improve the radio's performance and to produce radios with interesting features. In this case few (external) parts have to be changed or added. By using all or some of the options offered by the U2510B different types or classes of radios can be designed to the customer's requirements with the same IC.

One of the general advantages of using the U2510B is the fact that all receiver functions (including the options) are integrated and tested on a system level. Therefore, two additional cost-savings are achieved by:

1. Shorter development time through less technical problems and
2. Higher reproductivity and low reject level in the set production line.

Another advantage, due to the technology of the U2510B, is the wide operating voltage range, especially the upper limit (13 V). This feature allows the use of soft power supply for line powered radios which can also reduce the set's total cost.

## Circuit Example

Figure 17 shows a circuit diagram for low end AM/AF radios using the U2510B. Figure 18 shows a circuit diagram of AM/AF radio for higher class designs using all possible options of the U2510B. The layout of the PC board, shown in figure 19, is suitable for both the circuit example shown in figure 17 and the circuit example shown in figure 18. The associated coil, varicon and filter specifications are listed in the table: COIL DATA and SPECIAL COMPONENT PARTS. The circuit diagram (figure 18), has the following options compared to the circuit diagram (figure 17) (the additional parts, which have to be provided, are listed in parentheses):

- a) Soft mute and high cut control in FM mode (1 cap.)
- b) Electronic treble control in AM, FM and TAPE mode (1 pot.)
- c) On-chip mode control for TAPE application
- d) RF AGC in FM mode (1 capacitor)
- e) AFC, adjustable to the correct polarity and slope (1 cap.)
- f) Tuning indication using LED as an indicator (1 LED, 1 cap.)

Option a) reduces the interstation noise by the two functions: soft mute and HCC. Both are controlled by the mute voltage (Pin 1). The soft mute reduces the loudness only, while the HCC reduces the high-end audio cut-off frequency of the audio preamplifier, when the signal level falls below a given threshold. This signal level threshold as well as the mute depth can be reduced by adding a resistor ( $R_3$ ) or by increasing the FM front-end gain.

Option b) allows the treble control for all operating modes without the need of an additional capacitor. This concept leads to a smooth and correct treble control behavior which is an improvement compared to the controlled RC network normally used.

Option c) is very useful for application in radio cassette-recorders, for instance. In TAPE mode, the AM/FM receiver blocks are completely switched off and the signal from the tape recorder can be fed to the audio amplifier's input directly. This saves quiescent current and makes the TAPE switching easy. However, to minimize switching noise by the mode switch, the following switch sequence should be chosen: AM, FM, TAPE.

Option d) improves the strong signal behavior by protecting the FM mixer against overload. This is provided by the integrated broad-band-width RF AGC. If necessary, the AGC threshold can be decreased by a resistor, loading Pin 11 to GND (not shown).

Option e) improves the tuning behavior substantially. The special design of the on-chip AFC function means that common disadvantages such as asymmetrical slope, (chip-) temperature effects and unlimited holding range are avoided. As mentioned in the "Pinning Description Table", the AFC slope has to be inverted when the local oscillator (LO) frequency has to be below the receiving frequency. This can be achieved by connecting Pin 21 to the potential of Pin 8. In addition to the options described above, the following proposals are implemented in the circuit diagram (figure 18), too:

- An FM IFT is applied. This improves the channel selectivity and minimizes substantially the spurious responses caused by the FM ceramic filter ( $CF_2$ ). With the choice of the winding ratio of this IFT, the FM front end gain can be matched to other values if necessary.
- In the FM RF input section, the low cost antenna filter ( $L_5$ ,  $C_{15}$ ) is replaced by a special band pass filter (PFWE8). Such a BPF protects the FM front end against the out-off-band interference signals (TV channels, etc.) which could disturb the FM reception.

## Design Hints

The value of the power supply blocking capacitor  $C_{13}$  should not be below 470  $\mu$ F. In addition, this capacitor should be placed near Pin 26. This will help to avoid unacceptable noise generated by noise-radiation from the audio amplifier via the bar-antenna. In designs, where the supply voltage goes below 2.5 V, the value of the blocking capacitor ( $C_7$ ) should be chosen as 47  $\mu$ F or even higher. To achieve a high rejection of short wave reception in medium wave operation, the LO amplitude at Pin 5 should not exceed approximately 200 mV. This LO amplitude depends on the LO transformer's Q and its turns ratio. For the LO transformer type described in the "Coil Data Table", a resistor  $R_4$  (2.2 k $\Omega$  for example) in parallel to the secondary side of the AM LO transformer  $T_2$  is recommended. To minimize feedback effects in the RF/IF part in FM mode, the capacitor  $C_6$  should be placed as near to Pins 8 and 20 as possible.

As shown in the application circuit diagrams (figures 17 and 18), in FM mode ceramic filter devices are used for channel selection ( $CF_2$ ) while for FM, demodulation in LC-discriminator circuit ( $T_4$ ,  $C_{24}$ ,  $C_{25}$ ) is used instead of a ceramic discriminator device.

Such an LC discriminator circuit can be easily matched to the FM IF selectivity block by its alignment. The zero-crossing of the discriminator can be detected at the demodulator output (Pin 23). The zero-crossing voltage is equal to half of the regulated voltage at Pin 8.



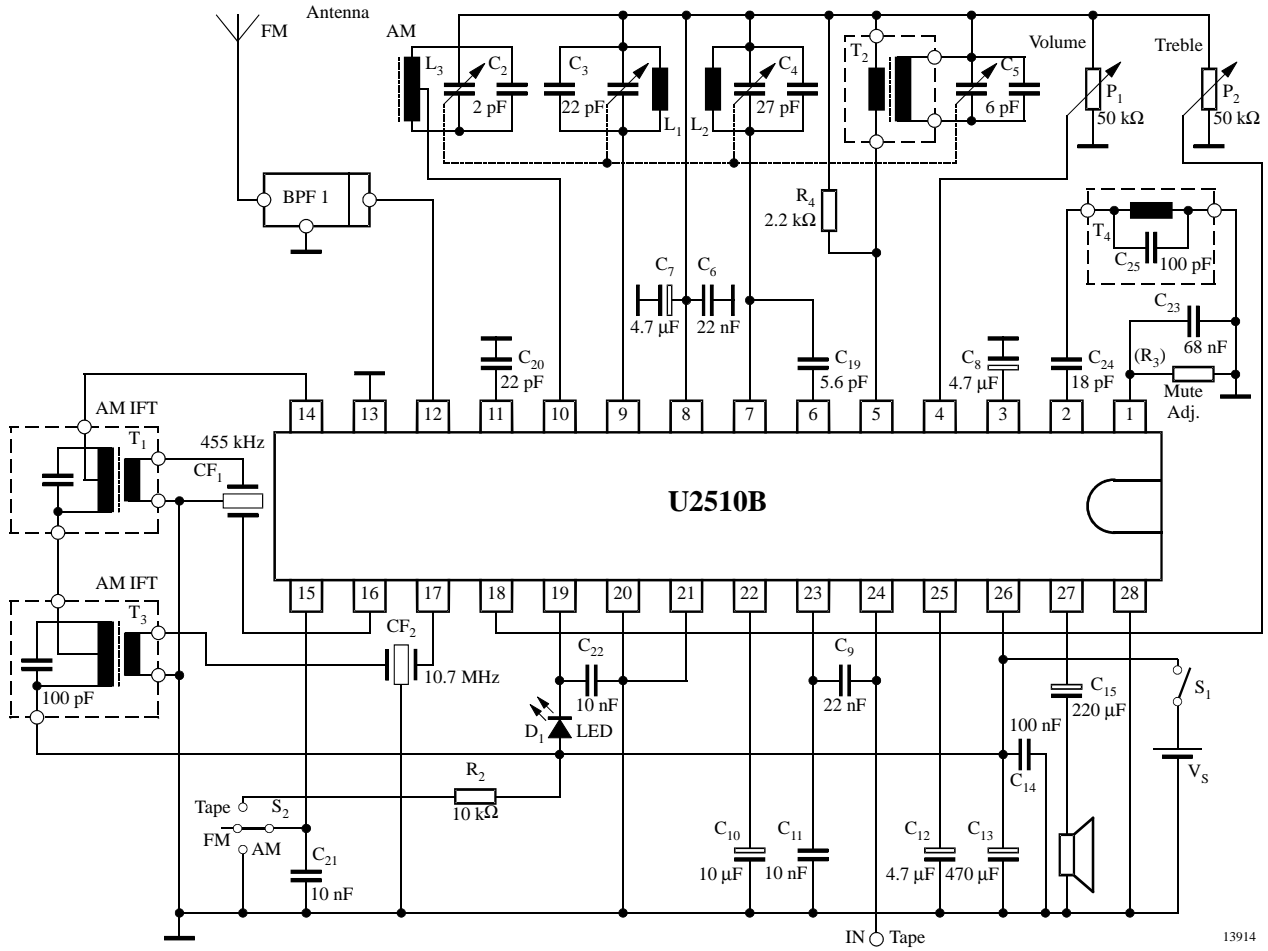

Figure 18. Application circuit (upgraded) R<sub>2</sub> only if V<sub>S</sub> > 8 V

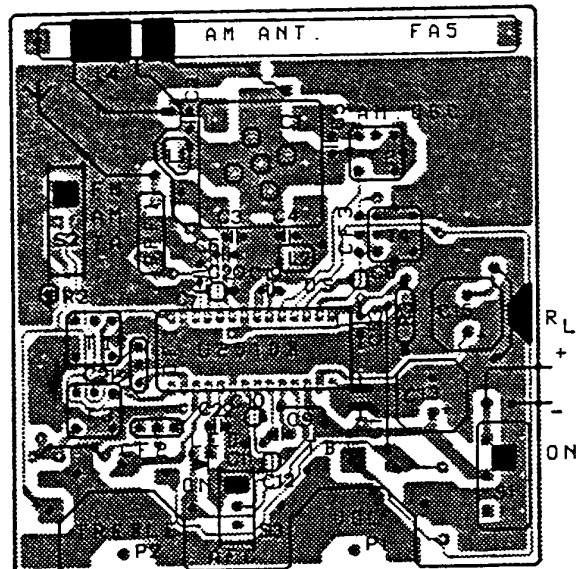
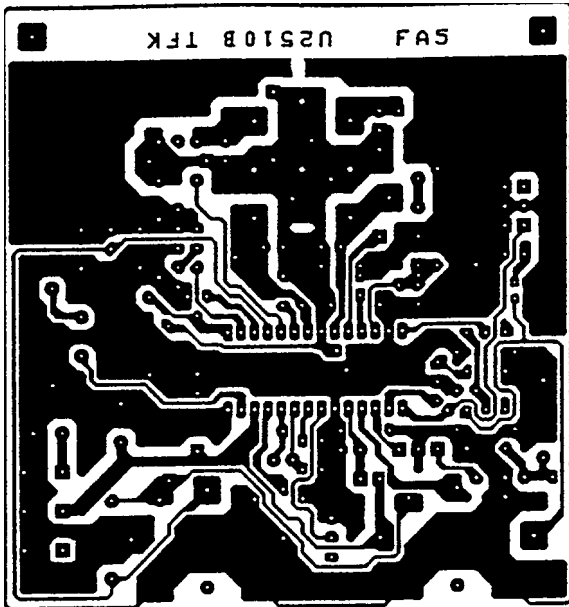

Figure 19. PC-board

## Coil Data and Special Component Part

Part	Stage	L or C <sub>0</sub> between	Q <sub>0</sub> between	Wire diameter/mm			Type Manufacturer
				Terminal No.	Number of turns		
T <sub>1</sub>	AM IFT	180 pF 1 to 3	90 1 to 3	0.07 1 to 2 111	0.07 2 to 3 35	0.07 4 to 6 7	7MC-7789N Toko 21K7-H5 Mitsumi
T <sub>2</sub>	AM OSC	270 μH 1 to 3	125 1 to 3	0.06 1 to 3 107	0.06 4 to 6 29		7TRS-8441 Toko L-5K7-H5 Mitsumi
T <sub>3</sub>	FM IFT (optional)	100 pF 1 to 3		0.09 1 to 2 3	0.09 2 to 3 7	0.09 4 to 6 2	mat.: 7P A119 AC Toko
T <sub>4</sub>	FM discrimi- nator	100 pF 1 to 3		0.09 1 to 3 10			mat.: 7P A119 AC Toko
L <sub>1</sub>	FM RF air coil 4 mm diam.			0.62  3.75			
L <sub>2</sub>	FM OSC air coil 4 mm diam.			0.62  3.75			
L <sub>4</sub>	FM antenna air coil 4 mm diam.			0.62  4.75			

L <sub>3</sub>	AM bar antenna	L: 630 μH	total turns : 96	tap: 19
BPF1	(optional)	PFWE8 (88 to 108 MHz)		Soshin Electric Co.
CF <sub>1</sub>		SFU-455B BFCFL-455		Murata Toko
CF <sub>2</sub>		SFE10.7MA5 CFSK 107M1		Murata Toko
CF <sub>3</sub>	(optional)	CDA10.7MC1		Murata
C <sub>1</sub>	Variable capacitor	HD22124	AM/FM	Toko

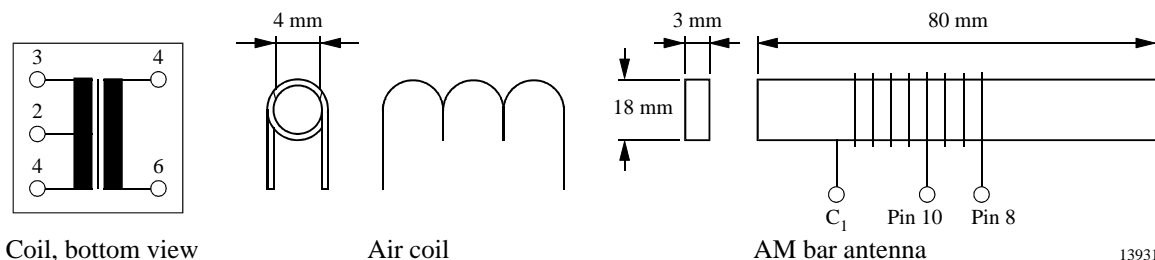
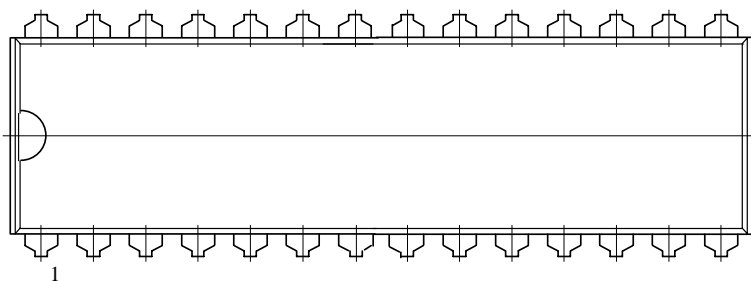
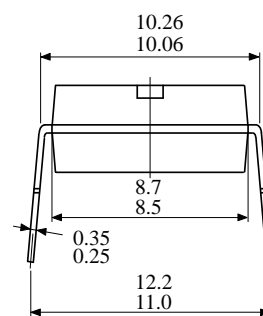
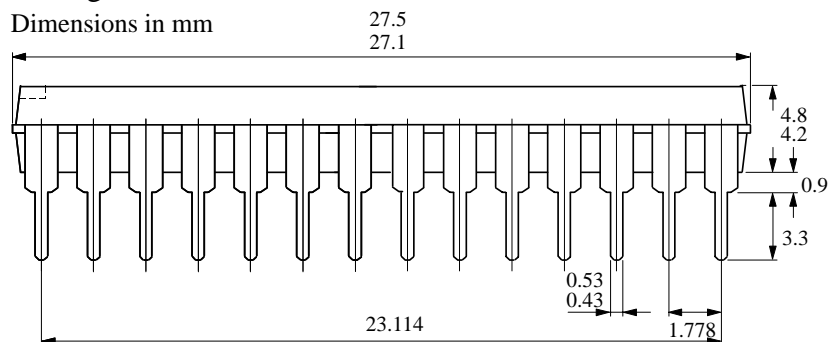

Figure 20.

## Package Information

### Package SDIP28

Dimensions in mm

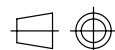

  
technical drawings  
according to DIN  
specifications

13044

---

## Ozone Depleting Substances Policy Statement

It is the policy of **TEMIC Semiconductor GmbH** to

1. Meet all present and future national and international statutory requirements.
2. Regularly and continuously improve the performance of our products, processes, distribution and operating systems with respect to their impact on the health and safety of our employees and the public, as well as their impact on the environment.

It is particular concern to control or eliminate releases of those substances into the atmosphere which are known as ozone depleting substances (ODSs).

The Montreal Protocol (1987) and its London Amendments (1990) intend to severely restrict the use of ODSs and forbid their use within the next ten years. Various national and international initiatives are pressing for an earlier ban on these substances.

**TEMIC Semiconductor GmbH** has been able to use its policy of continuous improvements to eliminate the use of ODSs listed in the following documents.

1. Annex A, B and list of transitional substances of the Montreal Protocol and the London Amendments respectively
2. Class I and II ozone depleting substances in the Clean Air Act Amendments of 1990 by the Environmental Protection Agency (EPA) in the USA
3. Council Decision 88/540/EEC and 91/690/EEC Annex A, B and C (transitional substances) respectively.

**TEMIC Semiconductor GmbH** can certify that our semiconductors are not manufactured with ozone depleting substances and do not contain such substances.

**We reserve the right to make changes to improve technical design and may do so without further notice.**

Parameters can vary in different applications. All operating parameters must be validated for each customer application by the customer. Should the buyer use TEMIC Semiconductors products for any unintended or unauthorized application, the buyer shall indemnify TEMIC Semiconductors against all claims, costs, damages, and expenses, arising out of, directly or indirectly, any claim of personal damage, injury or death associated with such unintended or unauthorized use.

TEMIC Semiconductor GmbH, P.O.B. 3535, D-74025 Heilbronn, Germany  
Telephone: 49 (0)7131 67 2594, Fax number: 49 (0)7131 67 2423