

SIPMOS[®] Power Transistor

- N channel
- Enhancement mode
- Avalanche-rated
- Logic Level
- dv/dt rated
- Ultra low on-resistance
- 175 °C operating temperature
- also in TO-220 SMD available

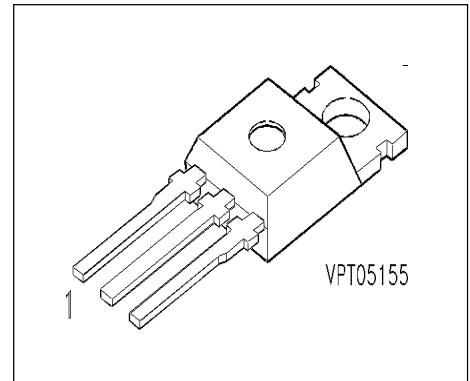

Pin 1	Pin 2	Pin 3
G	D	S

Type	V_{DS}	I_D	$R_{DS(on)}$	Package	Ordering Code
BUZ 100L	50 V	60 A	0.018 Ω	TO-220 AB	C67078-S1354-A2

Maximum Ratings

Parameter	Symbol	Values	Unit
Continuous drain current $T_C = 101\text{ °C}$	I_D	60	A
Pulsed drain current $T_C = 25\text{ °C}$	I_{Dpuls}	240	
Avalanche energy, single pulse $I_D = 60\text{ A}$, $V_{DD} = 25\text{ V}$, $R_{GS} = 25\text{ }\Omega$ $L = 70\text{ }\mu\text{H}$, $T_j = 25\text{ °C}$	E_{AS}	250	mJ
Reverse diode dv/dt $I_S = 60\text{ A}$, $V_{DS} = 40\text{ V}$, $di_F/dt = 200\text{ A}/\mu\text{s}$ $T_{jmax} = 175\text{ °C}$	dv/dt	6	kV/ μs
Gate source voltage	V_{GS}	± 14	V
Gate-source peak voltage, aperiodic	V_{gs}	± 20	
Power dissipation $T_C = 25\text{ °C}$	P_{tot}	250	W

Maximum Ratings

Parameter	Symbol	Values	Unit
Operating temperature	T_j	-55 ... + 175	°C
Storage temperature	T_{stg}	-55 ... + 175	
Thermal resistance, chip case	R_{thJC}	≤ 0.6	K/W
Thermal resistance, chip to ambient	R_{thJA}	≤ 75	
DIN humidity category, DIN 40 040		E	
IEC climatic category, DIN IEC 68-1		55 / 175 / 56	

Electrical Characteristics, at $T_j = 25^\circ\text{C}$, unless otherwise specified

Parameter	Symbol	Values			Unit
		min.	typ.	max.	

Static Characteristics

Drain- source breakdown voltage $V_{GS} = 0 \text{ V}, I_D = 0.25 \text{ mA}, T_j = -40 \text{ }^\circ\text{C}$	$V_{(BR)DSS}$	50	-	-	V
Gate threshold voltage $V_{GS}=V_{DS}, I_D = 1 \text{ mA}$	$V_{GS(th)}$	1.2	1.6	2	
Zero gate voltage drain current $V_{DS} = 50 \text{ V}, V_{GS} = 0 \text{ V}, T_j = 25 \text{ }^\circ\text{C}$	I_{DSS}	-	0.1	1	μA
$V_{DS} = 50 \text{ V}, V_{GS} = 0 \text{ V}, T_j = -40 \text{ }^\circ\text{C}$		-	1	100	nA
$V_{DS} = 50 \text{ V}, V_{GS} = 0 \text{ V}, T_j = 150 \text{ }^\circ\text{C}$		-	10	100	μA
Gate-source leakage current $V_{GS} = 20 \text{ V}, V_{DS} = 0 \text{ V}$	I_{GSS}	-	10	100	nA
Drain-Source on-resistance $V_{GS} = 5 \text{ V}, I_D = 30 \text{ A}$	$R_{DS(on)}$	-	0.014	0.018	Ω

Electrical Characteristics, at $T_j = 25^\circ\text{C}$, unless otherwise specified

Parameter	Symbol	Values			Unit
		min.	typ.	max.	
Dynamic Characteristics					
Transconductance $V_{DS} \geq 2 \cdot I_D \cdot R_{DS(on)max}$, $I_D = 30\text{ A}$	g_{fs}	25	45	-	S
Input capacitance $V_{GS} = 0\text{ V}$, $V_{DS} = 25\text{ V}$, $f = 1\text{ MHz}$	C_{iss}	-	2800	3750	pF
Output capacitance $V_{GS} = 0\text{ V}$, $V_{DS} = 25\text{ V}$, $f = 1\text{ MHz}$	C_{oss}	-	830	1250	
Reverse transfer capacitance $V_{GS} = 0\text{ V}$, $V_{DS} = 25\text{ V}$, $f = 1\text{ MHz}$	C_{rss}	-	350	525	
Turn-on delay time $V_{DD} = 30\text{ V}$, $V_{GS} = 5\text{ V}$, $I_D = 3\text{ A}$ $R_{GS} = 50\ \Omega$	$t_{d(on)}$	-	45	70	ns
Rise time $V_{DD} = 30\text{ V}$, $V_{GS} = 5\text{ V}$, $I_D = 3\text{ A}$ $R_{GS} = 50\ \Omega$	t_r	-	140	210	
Turn-off delay time $V_{DD} = 30\text{ V}$, $V_{GS} = 5\text{ V}$, $I_D = 3\text{ A}$ $R_{GS} = 50\ \Omega$	$t_{d(off)}$	-	350	470	
Fall time $V_{DD} = 30\text{ V}$, $V_{GS} = 5\text{ V}$, $I_D = 3\text{ A}$ $R_{GS} = 50\ \Omega$	t_f	-	100	135	

Electrical Characteristics, at $T_j = 25^\circ\text{C}$, unless otherwise specified

Parameter	Symbol	Values			Unit
		min.	typ.	max.	
Reverse Diode					
Inverse diode continuous forward current $T_C = 25^\circ\text{C}$	I_S	-	-	60	A
Inverse diode direct current, pulsed $T_C = 25^\circ\text{C}$	I_{SM}	-	-	240	
Inverse diode forward voltage $V_{GS} = 0\text{ V}, I_F = 120\text{ A}$	V_{SD}	-	1.15	1.8	V
Reverse recovery time $V_R = 30\text{ V}, I_F = I_S, di_F/dt = 100\text{ A}/\mu\text{s}$	t_{rr}	-	85	-	ns
Reverse recovery charge $V_R = 30\text{ V}, I_F = I_S, di_F/dt = 100\text{ A}/\mu\text{s}$	Q_{rr}	-	130	-	μC

Power dissipation

$$P_{\text{tot}} = f(T_C)$$

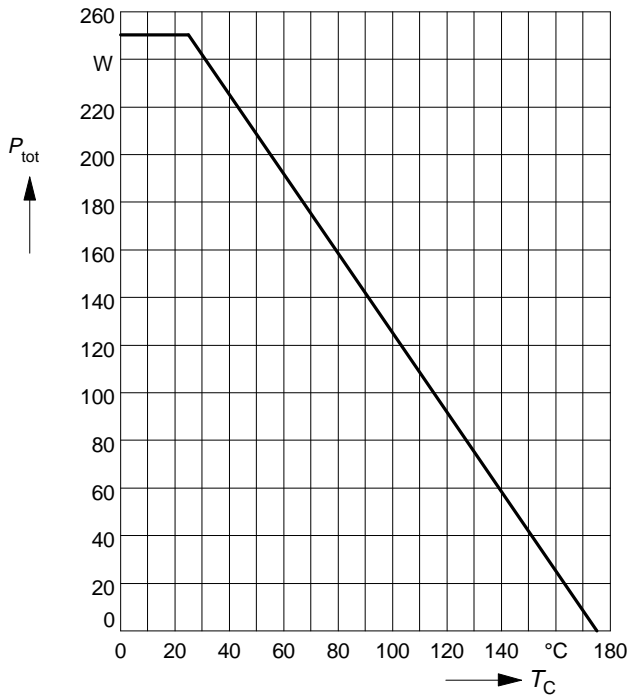

Drain current

$$I_D = f(T_C)$$

parameter: $V_{GS} \geq 5 \text{ V}$

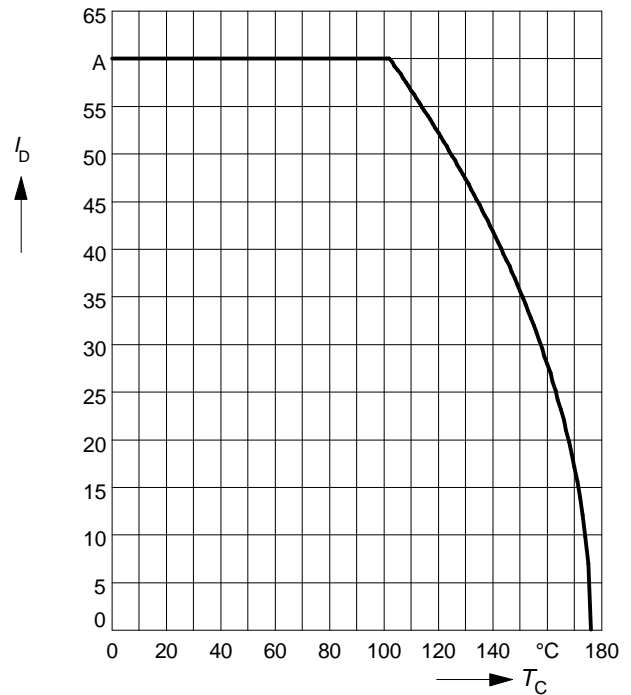

Safe operating area

$$I_D = f(V_{DS})$$

parameter: $D = 0.01, T_C = 25^\circ\text{C}$

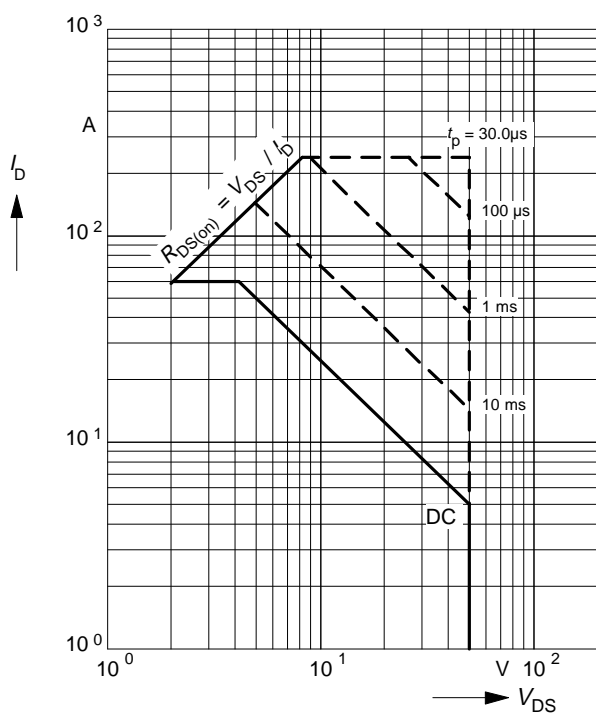

Transient thermal impedance

$$Z_{\text{thJC}} = f(t_p)$$

parameter: $D = t_p / T$

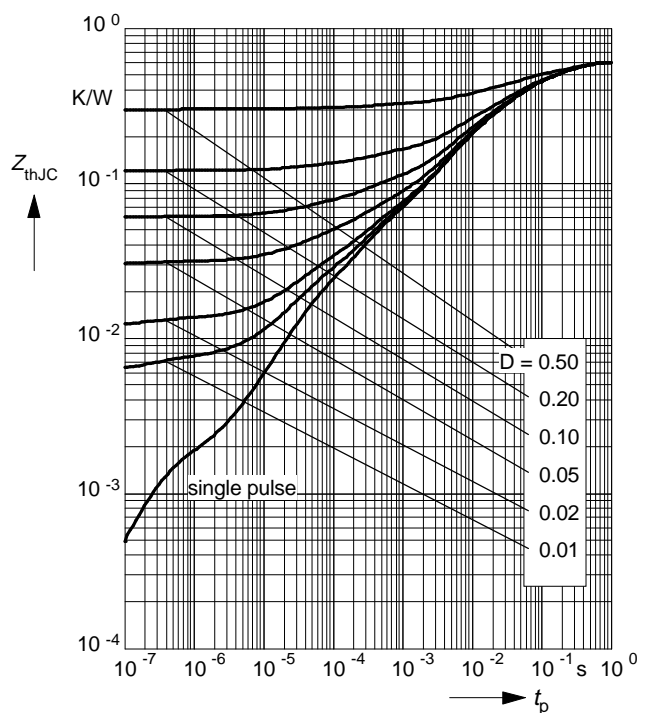

Typ. output characteristics

$$I_D = f(V_{DS})$$

parameter: $t_p = 80 \mu s$

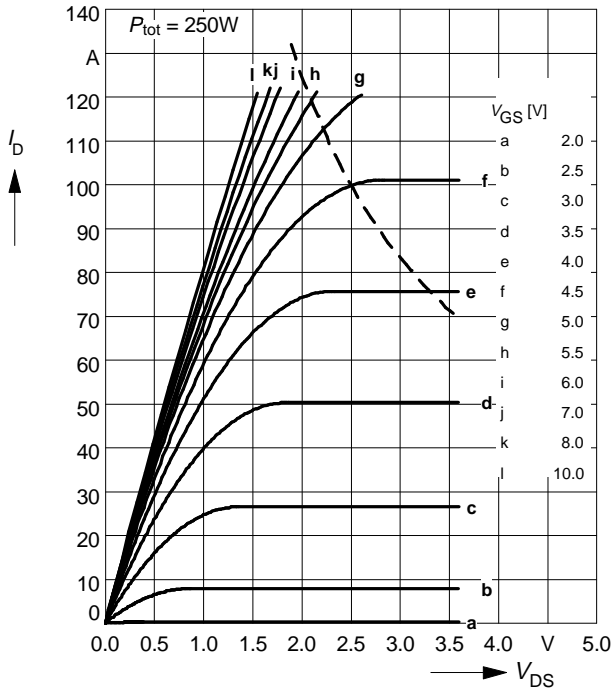

Drain-source on-resistance

$$R_{DS(on)} = f(T_j)$$

parameter: $I_D = 30 A, V_{GS} = 5 V$

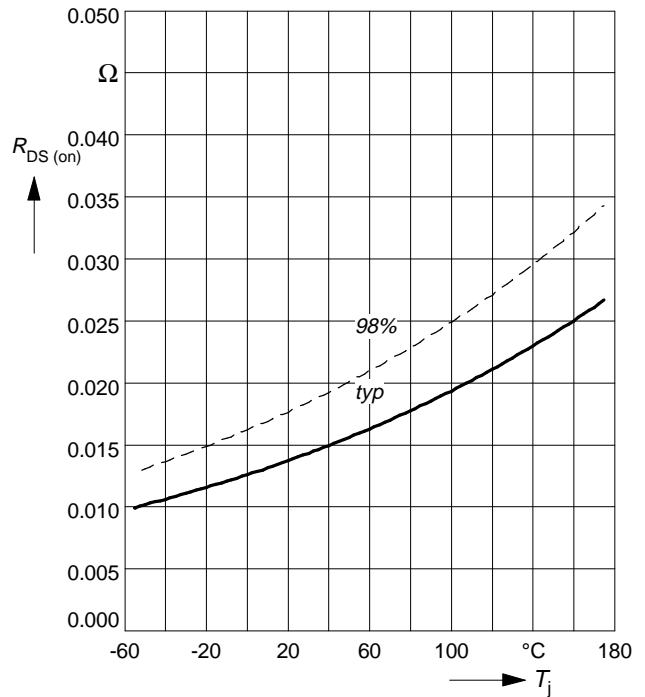

Typ. transfer characteristics $I_D = f(V_{GS})$

parameter: $t_p = 80 \mu s$

$$V_{DS} \geq 2 \times I_D \times R_{DS(on)max}$$

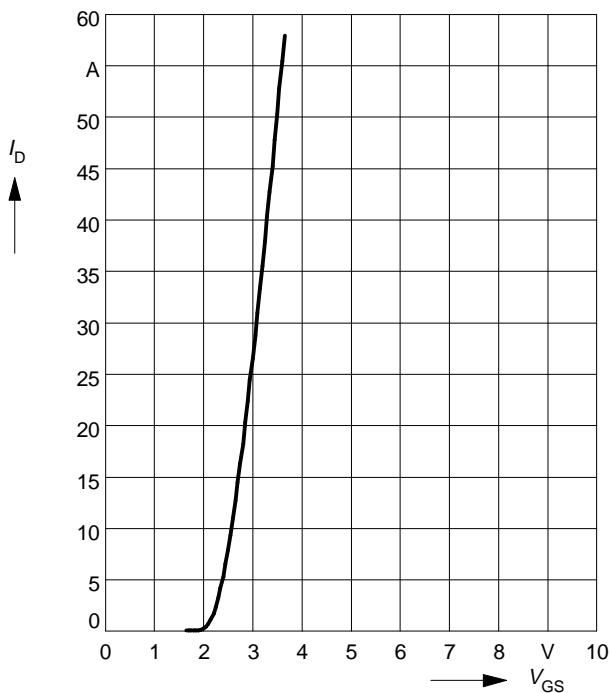

Typ. forward transconductance $g_{fs} = f(I_D)$

parameter: $t_p = 80 \mu s,$

$$V_{DS} \geq 2 \times I_D \times R_{DS(on)max}$$

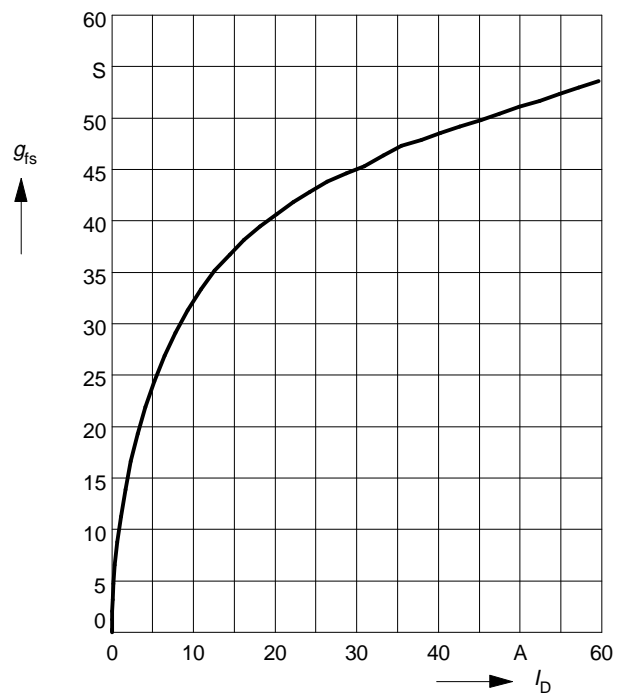

Typ. drain-source on-resistance

$R_{DS(on)} = f(I_D)$
parameter: V_{GS}

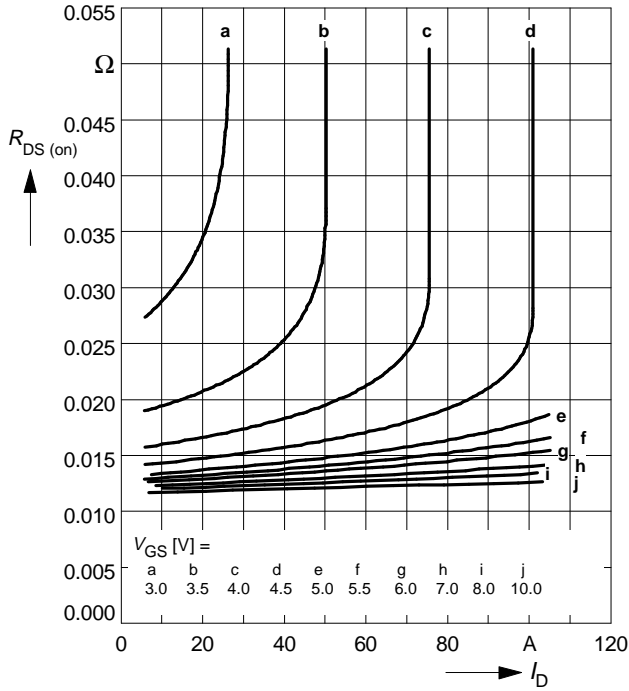

Gate threshold voltage

$V_{GS(th)} = f(T_j)$
parameter: $V_{GS} = V_{DS}, I_D = 1 \text{ mA}$

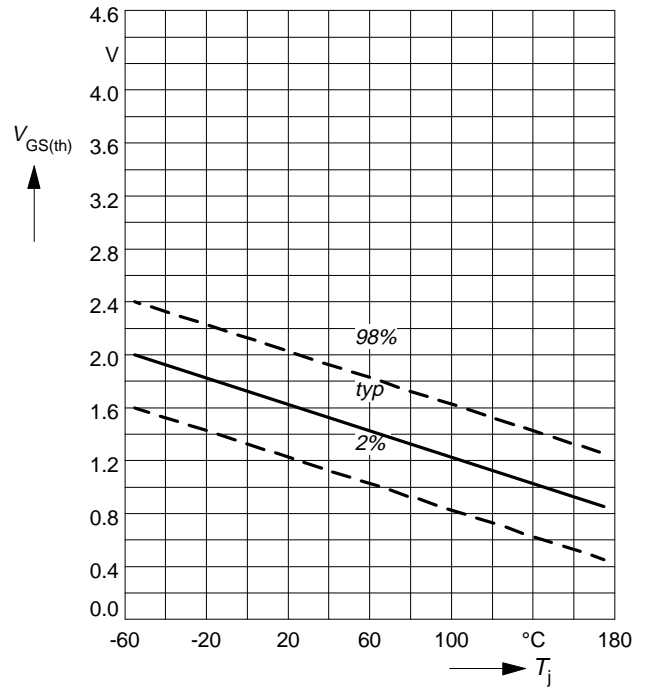

Typ. capacitances

$C = f(V_{DS})$
parameter: $V_{GS} = 0\text{V}, f = 1\text{MHz}$

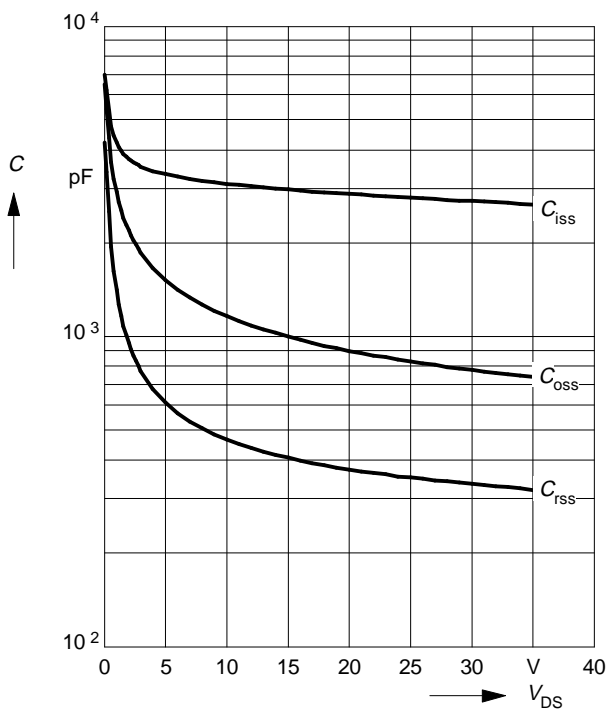

Forward characteristics of reverse diode

$I_F = f(V_{SD})$
parameter: $T_j, t_p = 80 \mu\text{s}$

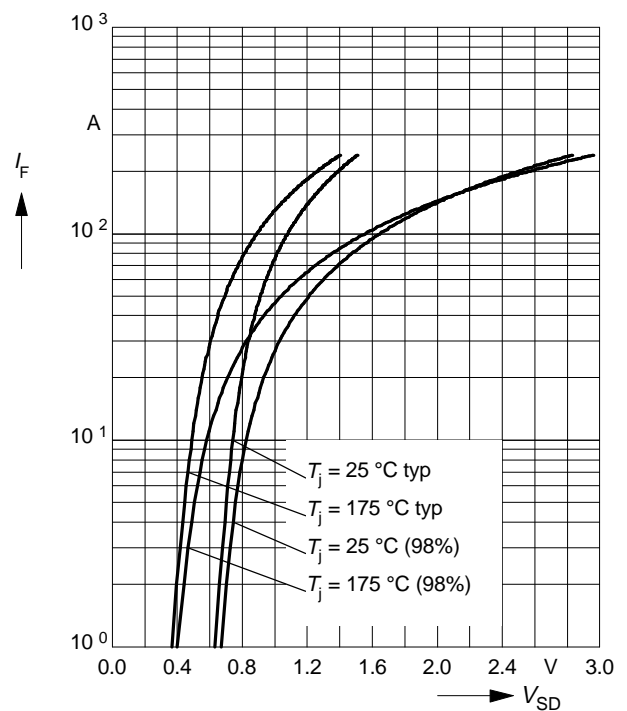

Avalanche energy $E_{AS} = f(T_j)$

parameter: $I_D = 60 \text{ A}$, $V_{DD} = 25 \text{ V}$

$R_{GS} = 25 \text{ } \Omega$, $L = 70 \text{ } \mu\text{H}$

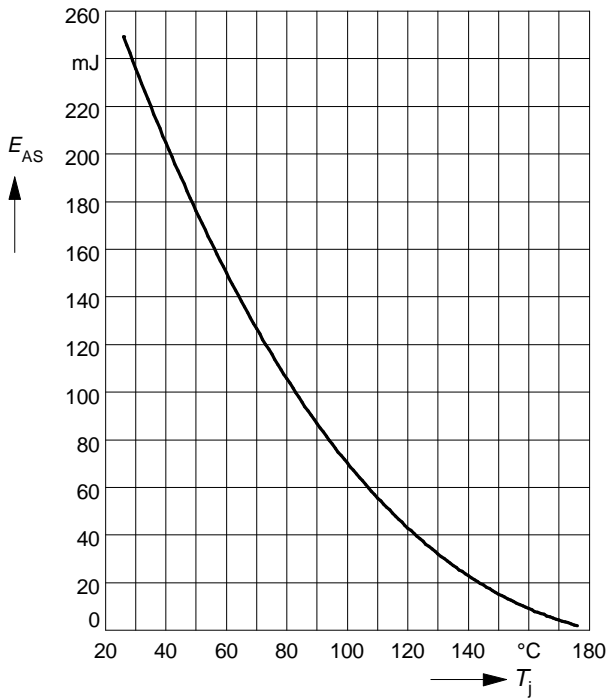

Typ. gate charge

$V_{GS} = f(Q_{Gate})$

parameter: $I_{D \text{ puls}} = 90 \text{ A}$

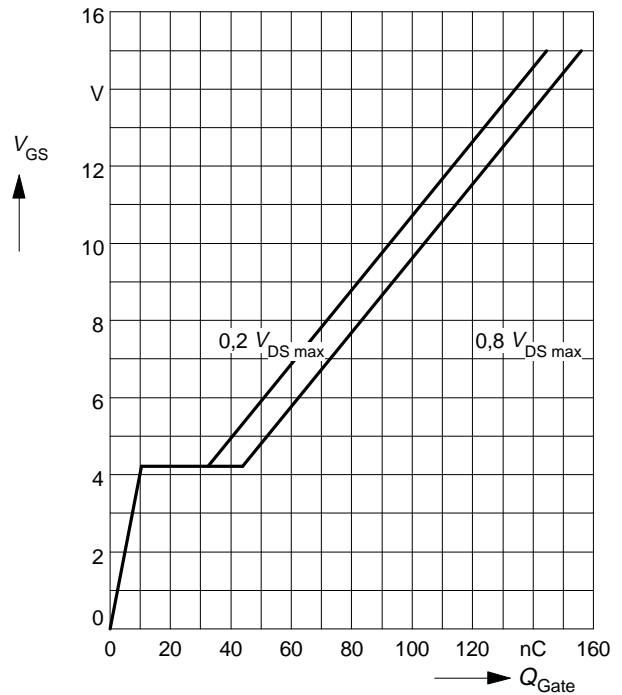

Drain-source breakdown voltage

$V_{(BR)DSS} = f(T_j)$

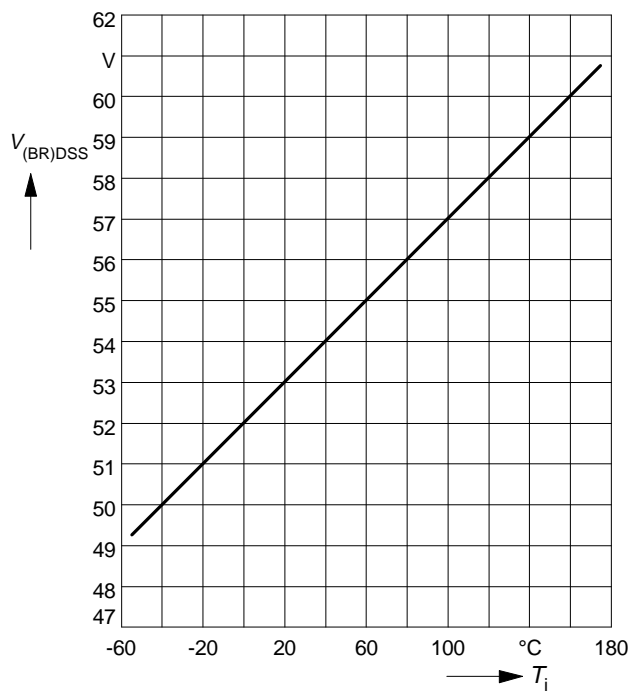

Package Outlines

TO-220 AB

Dimension in mm

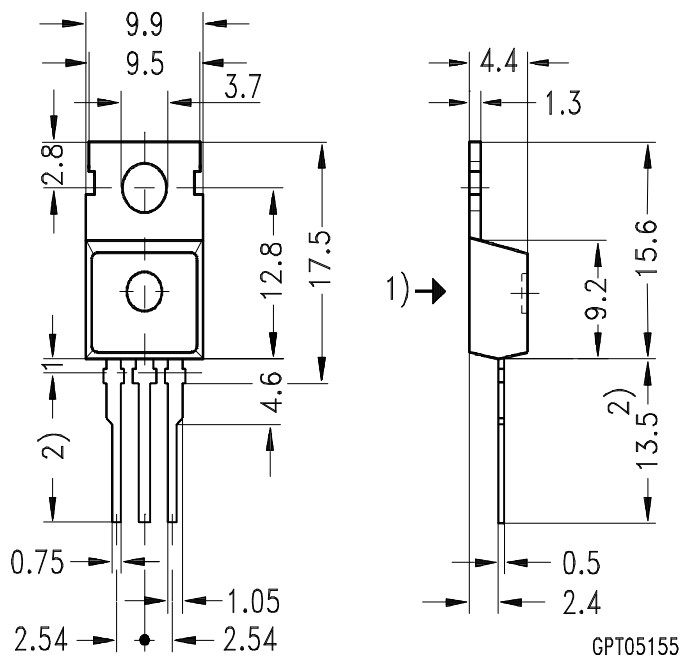

- 1) punch direction, burr max. 0.04
- 2) dip tinning
- 3) max. 14.5 by dip tinning press burr max. 0.05