

5A and 2.5A High Efficiency Switching Regulators

FEATURES

- Wide Input Voltage Range 3V–60V
- Low Quiescent Current—6mA
- Internal 5A Switch (2.5A for LT1071)
- Very Few External Parts Required
- Self-Protected Against Overloads
- Operates in Nearly All Switching Topologies
- Shutdown Mode Draws Only 50 μ A Supply Current
- Flyback-Regulated Mode has Fully Floating Outputs
- Comes in Standard 5-Pin Packages
- Can be Externally Synchronized (Consult Factory)

APPLICATIONS

- Logic Supply 5V @ 10A
- 5V Logic to \pm 15V Op Amp Supply
- Offline Converter up to 200W
- Battery Upconverter
- Power Inverter (+ to -) or (- to +)
- Fully Floating Multiple Outputs
- For Lower Current Applications see LT1072

USER NOTE:

This data sheet is only intended to provide specifications, graphs, and a general functional description of the LT1070/LT1071. Application circuits are included to show the capability of the LT1070/LT1071. A complete design manual (AN-19) should be obtained to assist in developing new designs. This manual contains a comprehensive discussion of both the LT1070 and the external components used with it, as well as complete formulas for calculating the values of these components. The manual can also be used for the LT1071 by factoring in the lower switch current rating. A second application note, AN-25, which details off-line applications is available.

DESCRIPTION

The LT1070 and LT1071 are monolithic high power switching regulators. They can be operated in all standard switching configurations including buck, boost, flyback, forward, inverting and "Cuk". A high current, high efficiency switch is included on the die along with all oscillator, control, and protection circuitry. Integration of all functions allows the LT1070/LT1071 to be built in a standard 5-pin TO-3 or TO-220 power package. This makes it extremely easy to use and provides "bust proof" operation similar to that obtained with 3-pin linear regulators.

The LT1070/LT1071 operates with supply voltages from 3V to 60V, and draws only 6mA quiescent current. It can deliver load power up to 100 watts with no external power devices. By utilizing current-mode switching techniques, it provides excellent AC and DC load and line regulation.

The LT1070/LT1071 has many unique features not found even on the vastly more difficult to use low power control chips presently available. It uses adaptive anti-sat switch drive to allow very wide ranging load currents with no loss in efficiency. An externally activated shutdown mode reduces total supply current to 50 μ A typical for standby operation. Totally isolated and regulated outputs can be generated by using the optional "flyback regulation mode" built into the LT1070/LT1071, without the need for opto-couplers or extra transformer windings.

5

TYPICAL APPLICATION

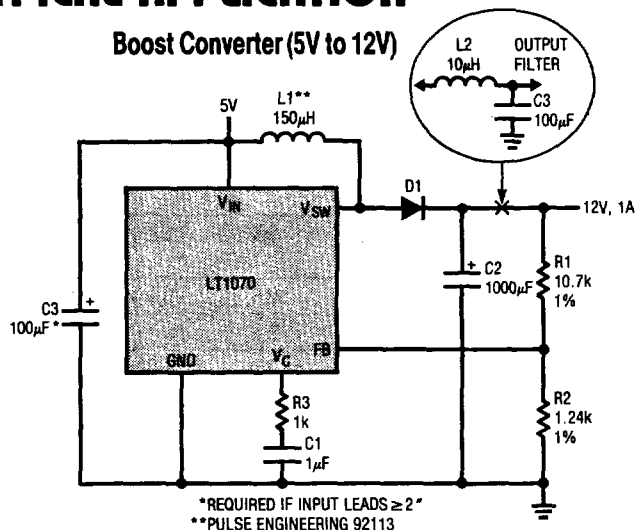

Maximum Output Power*

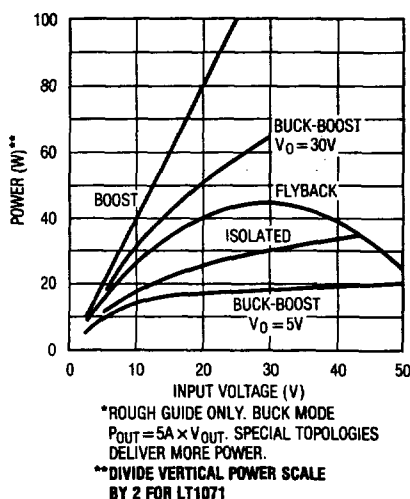

ABSOLUTE MAXIMUM RATINGS

Supply Voltage	
LT1070/71HV (See Note 1)	60V
LT1070/71 (See Note 1)	40V
Switch Output Voltage	
LT1070/71HV	75V
LT1070/71	65V
Feedback Pin Voltage (Transient, 1ms)	± 15V
Operating Junction Temperature Range	
LT1070/71HVM, LT1070/71M	-55°C to +150°C
LT1070/71HVC, LT1070/71C (Oper.)	0°C to +100°C
LT1070/71HVC, LT1070/71C (Sh. Ckt.)	0°C to +125°C
Storage Temperature Range	-65°C to +150°C
Lead Temperature (Soldering, 10sec)	300°C

Note 1: Minimum switch "on" time for the LT1070/LT1071 in current limit is $\approx 1.0\mu\text{sec}$. This limits the maximum input voltage during short circuit conditions, in the buck and inverting modes only, to $\approx 35\text{V}$. Normal (unshorted) conditions are not affected. Mask changes are being implemented which will reduce minimum "on" time to $\leq 1\mu\text{sec}$, increasing maximum short circuit input voltage above 40V. If the present LT1070/LT1071 (contact factory for package date code) is being operated in the buck or inverting mode at high input voltages and short circuit conditions are expected, a resistor must be placed in series with the inductor, as follows:

PACKAGE/ORDER INFORMATION

<p>4 LEAD TO-3</p>	ORDER PART NUMBER
	LT1070/LT1071HVMK LT1070/LT1071MK LT1070/LT1071HVCK LT1070/LT1071CK
<p>5 LEAD TO-220</p>	LT1070/LT1071HVCT LT1070/LT1071CT

The value of the resistor is given by:

$$R = \frac{t \cdot f \cdot V_{IN} - V_f}{I_{(LIMIT)}} - R_L$$

t = Minimum "on" time of LT1070/LT1071 in current limit, $\approx 1\mu\text{s}$

f = Operating frequency (40kHz)

V_f = Forward voltage of external catch diode at I_(LIMIT)

I_(LIMIT) = Current limit of LT1070 ($\approx 8\text{A}$), LT1071 ($\approx 4\text{A}$)

R_L = Internal series resistance of inductor

ELECTRICAL CHARACTERISTICS

Unless otherwise specified, V_{IN} = 15V, V_C = 0.5V, V_{FB} = V_{REF}, output pin open.

SYMBOL	PARAMETER	CONDITIONS	MIN	TYP	MAX	UNITS
V _{REF}	Reference Voltage	Measured at Feedback Pin	1.224 1.214	1.244 1.244	1.264 1.274	V
I _B	Feedback Input Current	V _{FB} = V _{REF}		350	750 1100	nA
g _m	Error Amplifier Transconductance	$\Delta I_C = \pm 25\mu\text{A}$	3000 2400	4400	6000 7000	μmho
	Error Amplifier Source or Sink Current	V _C = 1.5V	150 120	200	350 400	μA μA
	Error Amplifier Clamp Voltage	Hi Clamp, V _{FB} = 1V Lo Clamp, V _{FB} = 1.5V	1.8 0.25	0.38	2.3 0.52	V V
	Reference Voltage Line Regulation	$3\text{V} \leq V_{IN} \leq V_{MAX}$			0.03	%/V
A _v	Error Amplifier Voltage Gain	$0.7\text{V} \leq V_C \leq 1.4\text{V}$	500	800	2000	V/V
	Minimum Input Voltage			2.6	3.0	V
I _Q	Supply Current	$3\text{V} \leq V_{IN} \leq V_{MAX}$, V _C = 0.6V		6	9	mA
	Control Pin Threshold	Duty Cycle = 0	0.8 0.6	0.9	1.08 1.25	V
	Normal/Flyback Threshold on Feedback Pin		0.4	0.45	0.54	V
V _{FB}	Flyback Reference Voltage	I _{FB} = 50 μA	15 14	16.3	17.6 18	V

ELECTRICAL CHARACTERISTICS

Unless otherwise specified, $V_{IN} = 15V$, $V_C = 0.5V$, $V_{FB} = V_{REF}$, output pin open.

SYMBOL	PARAMETER	CONDITIONS	MIN	TYP	MAX	UNITS
V_{FB}	Change in Flyback Reference Voltage	$0.05 \leq I_{FB} \leq 1mA$	4.5	6.8	8.5	V
	Flyback Reference Voltage Line Regulation	$I_{FB} = 50\mu A$ $3V \leq V_{IN} \leq V_{MAX}$		0.01	0.03	%/V
	Flyback Amplifier Transconductance (gm)	$\Delta I_C = \pm 10\mu A$	150	300	500	μmho
	Flyback Amplifier Source and Sink Current	$V_C = 1.5V$ Source $I_{FB} = 50\mu A$ Sink	● 15 ● 25	32 40	70 70	μA μA
BV	Output Switch Breakdown Voltage	$3V \leq V_{IN} \leq V_{MAX}$ LT1070/LT1071 $I_{SW} = 5mA$ LT1070HV/LT1071HV	● 65 ● 75	90 90		V V
V_{SAT}	Output Switch (Note 1) "On" Resistance	LT1070 LT1071	●	0.15 0.3	0.24 0.5	Ω Ω
	Control Voltage to Switch Current Transconductance	LT1070 LT1071		8 4		ΔV ΔV
I_{LIM}	Switch Current Limit (LT1070)	Duty Cycle $\leq 50\%$ $T_J \geq 25^\circ C$ Duty Cycle $\leq 50\%$ $T_J < 25^\circ C$ Duty Cycle = 80% (Note 2)	● 5 ● 5 ● 4		10 11 10	A A A
I_{LIM}	Switch Current Limit (LT1071)	Duty Cycle $\leq 50\%$ $T_J \geq 25^\circ C$ Duty Cycle $\leq 50\%$ $T_J < 25^\circ C$ Duty Cycle = 80% (Note 2)	● 2.5 ● 2.5 ● 2		5 5.5 5	A A A
$\frac{\Delta I_{IN}}{\Delta I_{SW}}$	Supply Current Increase During Switch On-Time			25	35	mA/A
f	Switching Frequency		● 35 33	40	45 47	kHz
DC (max)	Maximum Switch Duty Cycle		90	92	97	%
	Flyback Sense Delay Time			1.5		μs
	Shutdown Mode Supply Current	$3V \leq V_{IN} \leq V_{MAX}$ $V_C = 0.05V$		100	250	μA
	Shutdown Mode Threshold Voltage	$3V \leq V_{IN} \leq V_{MAX}$	● 100 50	150	250 300	mV mV

The ● denotes the specifications which apply over the full operating temperature range.

Note 1: Measured with V_C in hi clamp, $V_{FB} = 0.8V$. $I_{SW} = 4A$ for LT1070 and 2A for LT1071.

Note 2: For duty cycles (DC) between 50% and 80%, minimum guaranteed switch current is given by $I_{LIM} = 3.33(2 - DC)$ for the LT1070 and $I_{LIM} = 1.67(2 - DC)$ for the LT1071.

TYPICAL PERFORMANCE CHARACTERISTICS

Switch Current Limit vs Duty Cycle

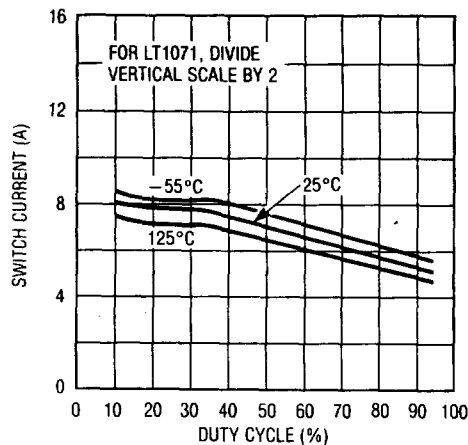

Maximum Duty Cycle

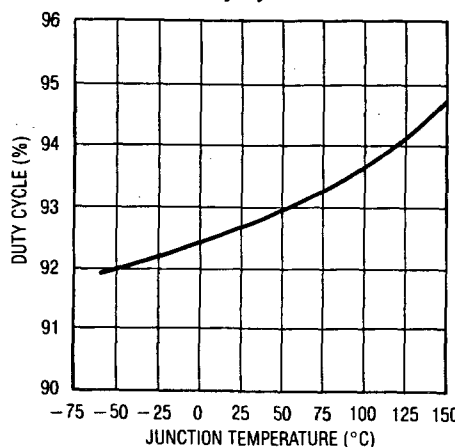

Flyback Blanking Time

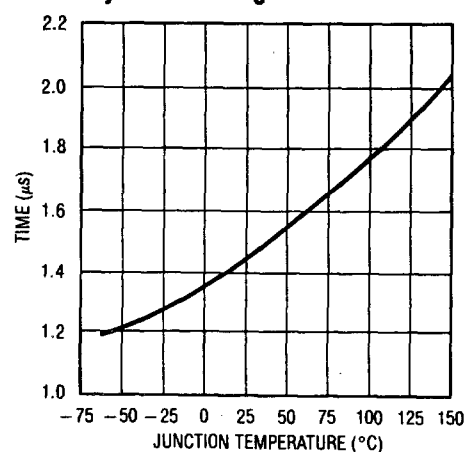

TYPICAL PERFORMANCE CHARACTERISTICS

Minimum Input Voltage

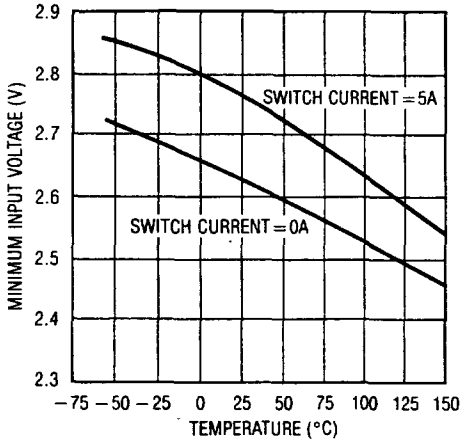

Switch Saturation Voltage

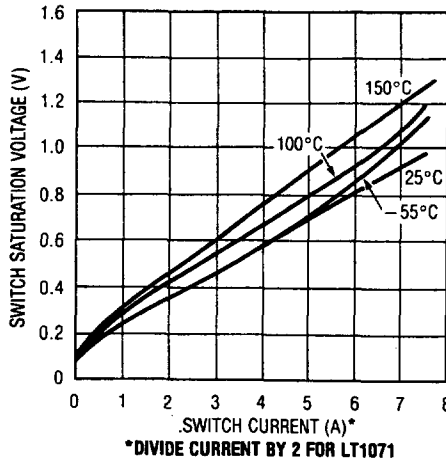

Isolated Mode Flyback Reference Voltage

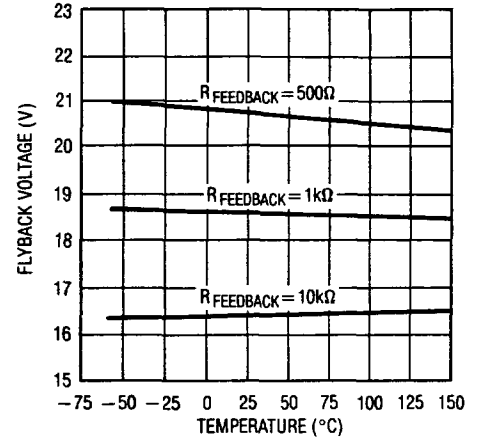

Line Regulation

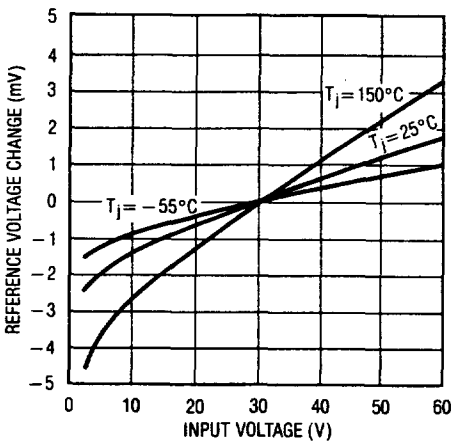

Reference Voltage vs Temperature

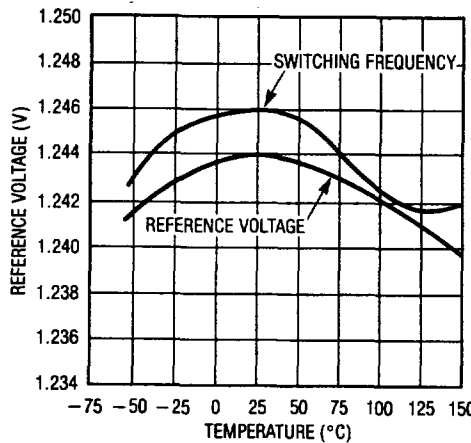

Feedback Bias Current vs Temperature

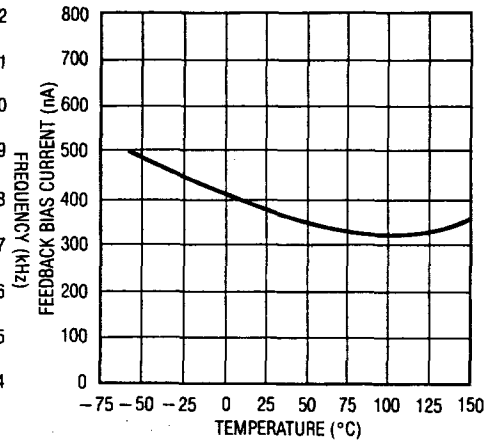

Driver Current* vs Switch Current

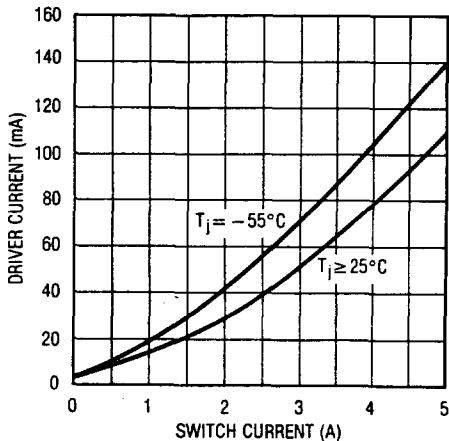

Supply Current vs Input Voltage*

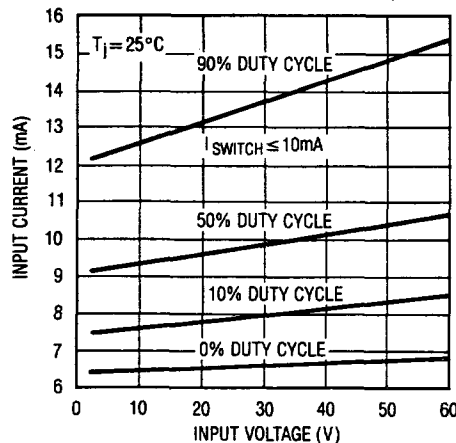

Supply Current vs Supply Voltage (Shutdown Mode)

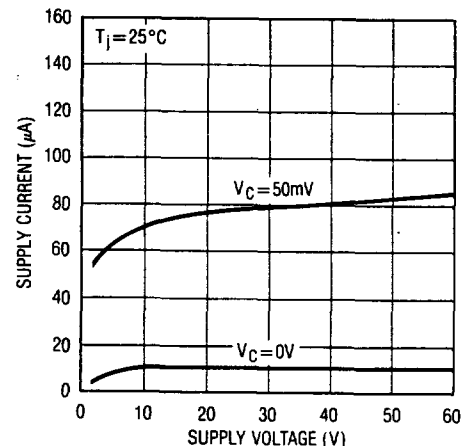

*AVERAGE LT1070 POWER SUPPLY CURRENT IS FOUND BY MULTIPLYING DRIVER CURRENT BY DUTY CYCLE, THEN ADDING QUIESCENT CURRENT.

*UNDER VERY LOW OUTPUT CURRENT CONDITIONS, DUTY CYCLE FOR MOST CIRCUITS WILL APPROACH 10% OR LESS.

TYPICAL PERFORMANCE CHARACTERISTICS

Normal/Flyback Mode Threshold on Feedback Pin

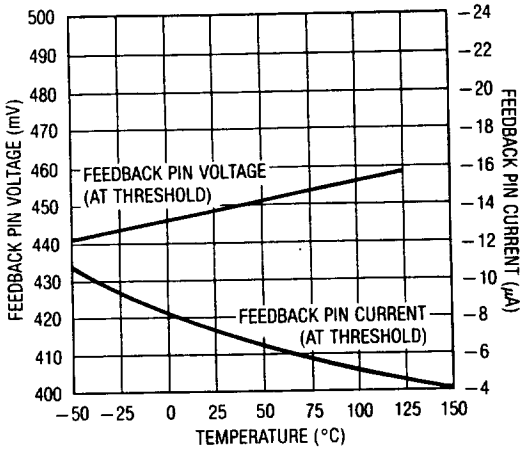

Shutdown Mode Supply Current

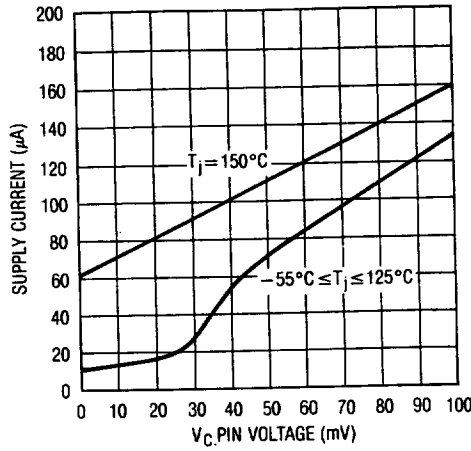

Error Amplifier Transconductance

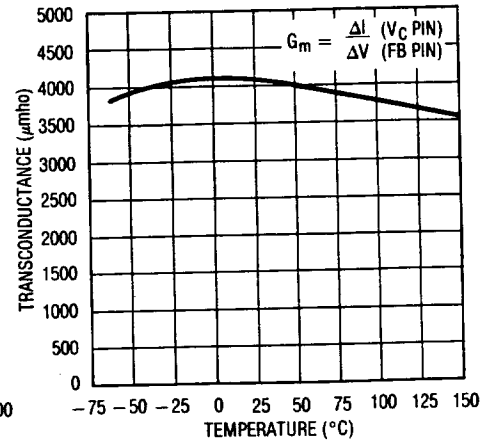

Shutdown Thresholds

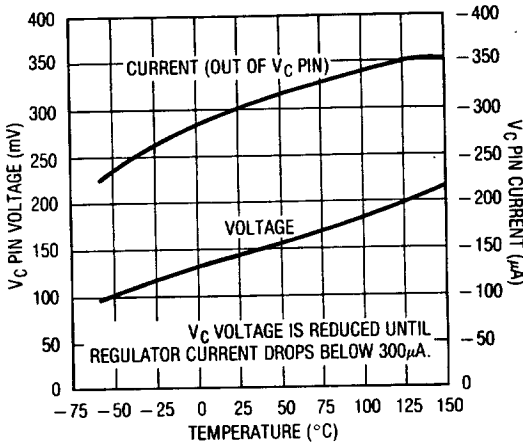

Idle Supply Current vs Temperature

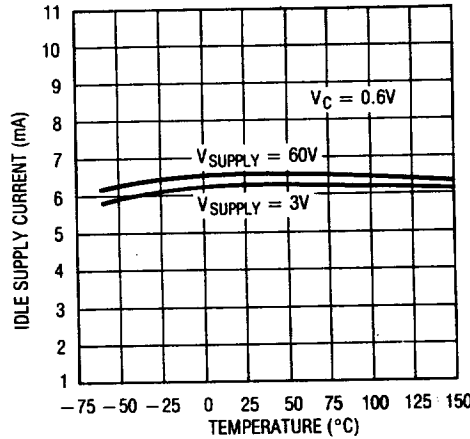

Feedback Pin Clamp Voltage

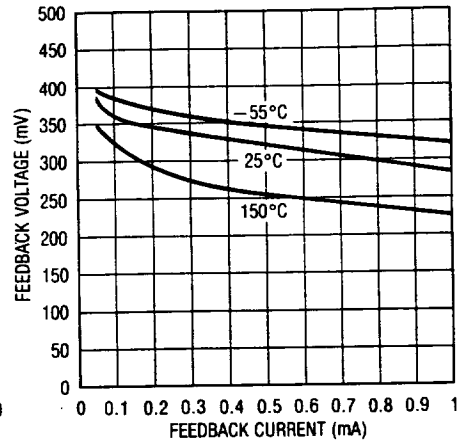

Switch "Off" Characteristics

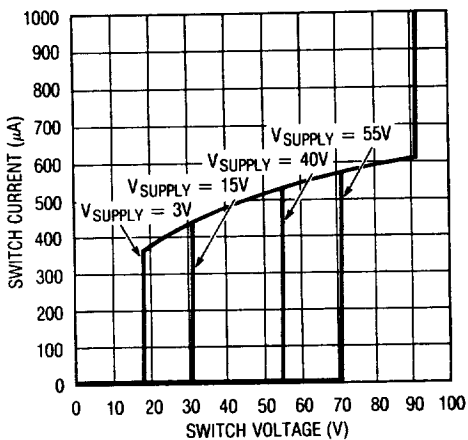

Vc Pin Characteristics

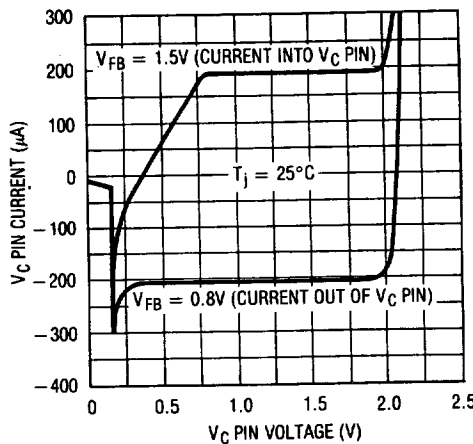

Transconductance of Error Amplifier

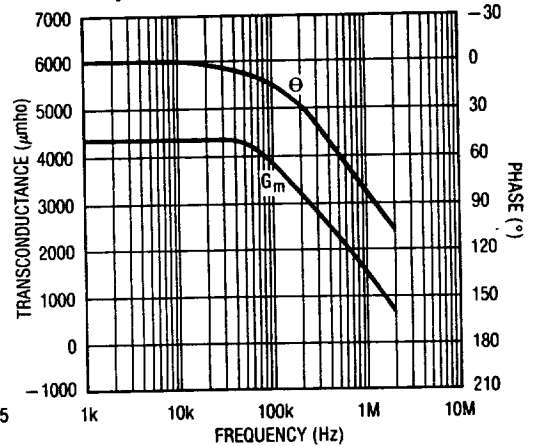

5

BLOCK DIAGRAM

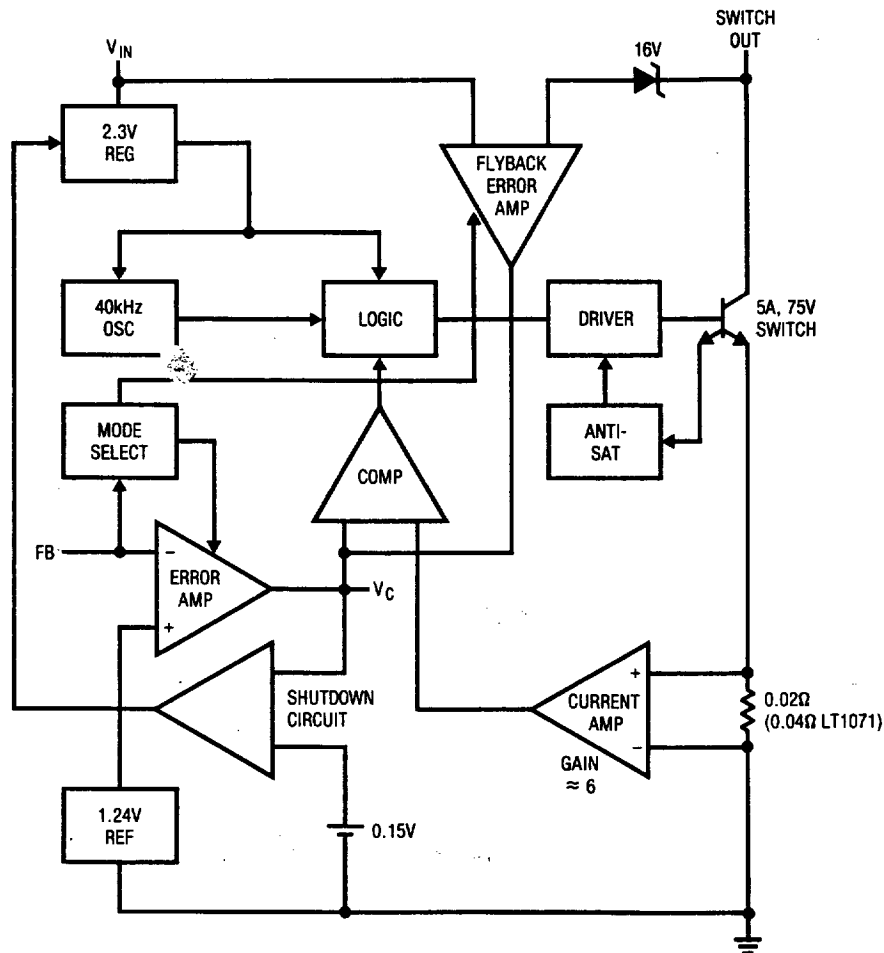

LT1070/LT1071 OPERATION

The LT1070/LT1071 is a current mode switcher. This means that switch duty cycle is directly controlled by switch current rather than by output voltage. Referring to the block diagram, the switch is turned "on" at the start of each oscillator cycle. It is turned "off" when switch current reaches a predetermined level. Control of output voltage is obtained by using the output of a voltage sensing error amplifier to set current trip level. This technique has several advantages. First, it has immediate response to input voltage variations, unlike ordinary switchers which have notoriously poor line transient response. Second, it reduces the 90° phase shift at midfrequencies in the energy storage inductor. This greatly simplifies closed loop frequency compensation under widely varying input voltage or output load conditions. Finally, it allows simple pulse-by-pulse current limiting to provide maximum switch protection under output overload or short condi-

tions. A low-dropout internal regulator provides a 2.3V supply for all internal circuitry on the LT1070/LT1071. This low-dropout design allows input voltage to vary from 3V to 60V with virtually no change in device performance. A 40kHz oscillator is the basic clock for all internal timing. It turns "on" the output switch via the logic and driver circuitry. Special adaptive anti-sat circuitry detects onset of saturation in the power switch and adjusts driver current instantaneously to limit switch saturation. This minimizes driver dissipation and provides very rapid turn-off of the switch.

A 1.2V bandgap reference biases the positive input of the error amplifier. The negative input is brought out for output voltage sensing. This feedback pin has a second function; when pulled low with an external resistor, it programs the LT1070/LT1071 to disconnect the main error amplifier output

LT1070/LT1071 OPERATION

and connects the output of the flyback amplifier to the comparator input. The LT1070/LT1071 will then regulate the value of the flyback pulse with respect to the supply voltage. This flyback pulse is directly proportional to output voltage in the traditional transformer coupled flyback topology regulator. By regulating the amplitude of the flyback pulse, the output voltage can be regulated with no direct connection between input and output. The output is fully floating up to the breakdown voltage of the transformer windings. Multiple floating outputs are easily obtained with additional windings. A special delay network inside the LT1070/LT1071 ignores the leakage inductance spike at the leading edge of the flyback pulse to improve output regulation.

The error signal developed at the comparator input is brought out externally. This pin (V_C) has four different functions. It is used for frequency compensation, current limit adjustment, soft starting, and total regulator shutdown. During normal regulator operation this pin sits at a voltage between 0.9V (low output current) and 2.0V (high output current). The error amplifiers are current output (gm) types, so this voltage can be externally clamped for adjusting current limit. Likewise, a capacitor coupled external clamp will provide soft start. Switch duty cycle goes to zero if the V_C pin is pulled to ground through a diode, placing the LT1070/LT1071 in an idle mode. Pulling the V_C pin below 0.15V causes total regulator shutdown, with only 50 μ A supply current for shutdown circuitry biasing. See AN-19 for full application details.

TYPICAL APPLICATIONS (Note that maximum output currents are divided by 2 for LT1071.)

Driving High Voltage FET
(for Offline Applications, See AN-25)

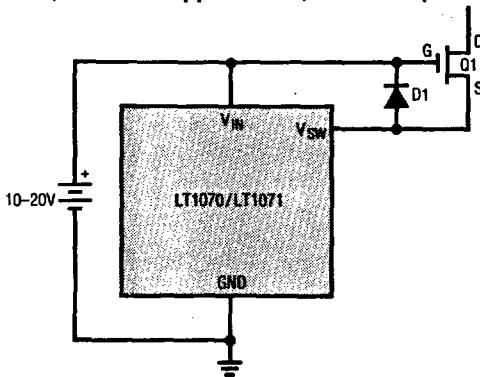

External Current Limit

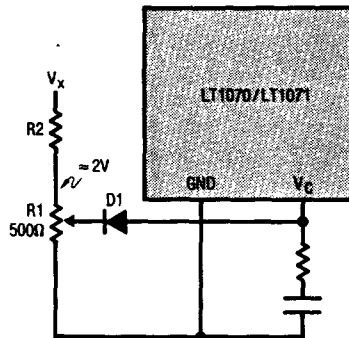

Negative to Positive Buck-Boost Converter

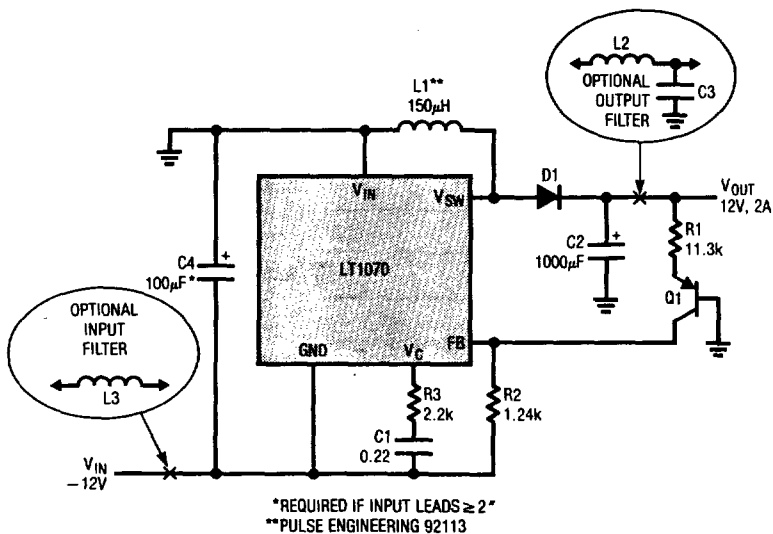

External Current Limit

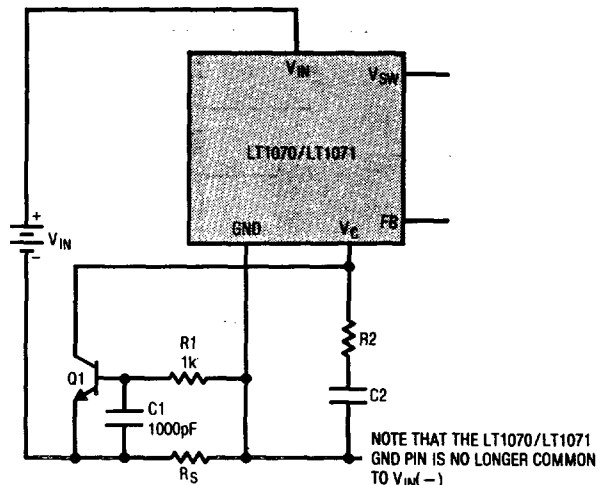

5

LT1070/LT1071

TYPICAL APPLICATIONS

Totally Isolated Converter

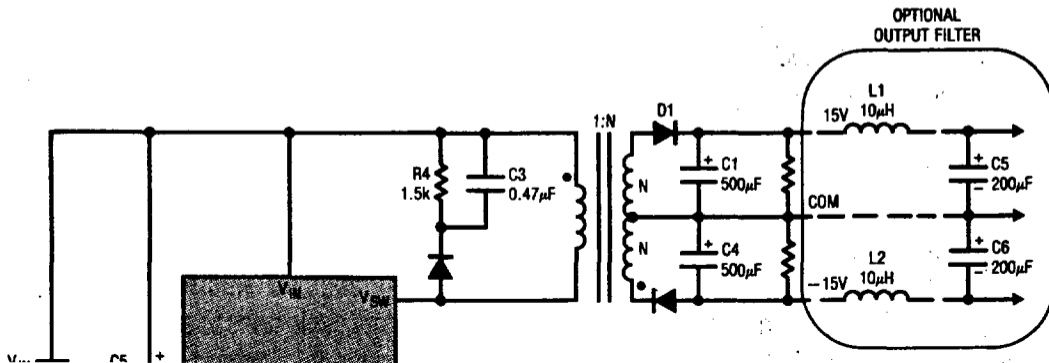

TYPICAL APPLICATIONS

Positive to Negative Buck-Boost Converter

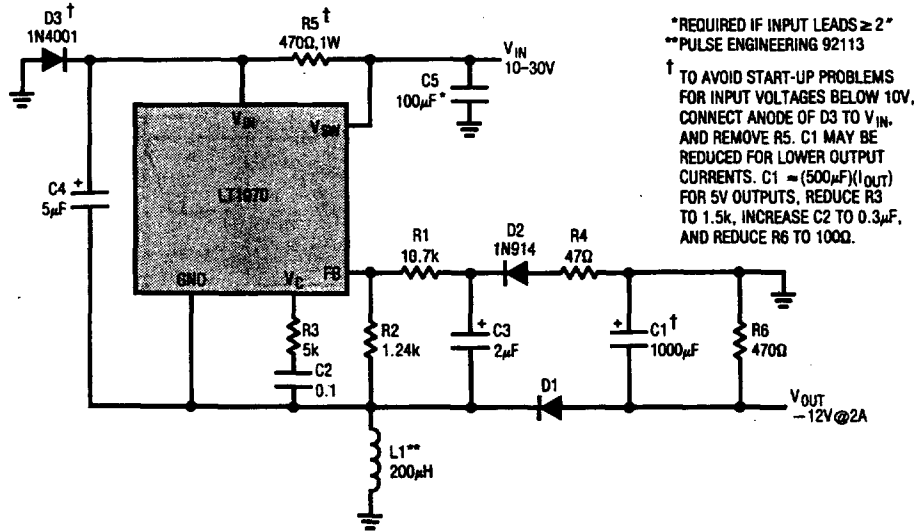

Voltage Boosted Boost Converter

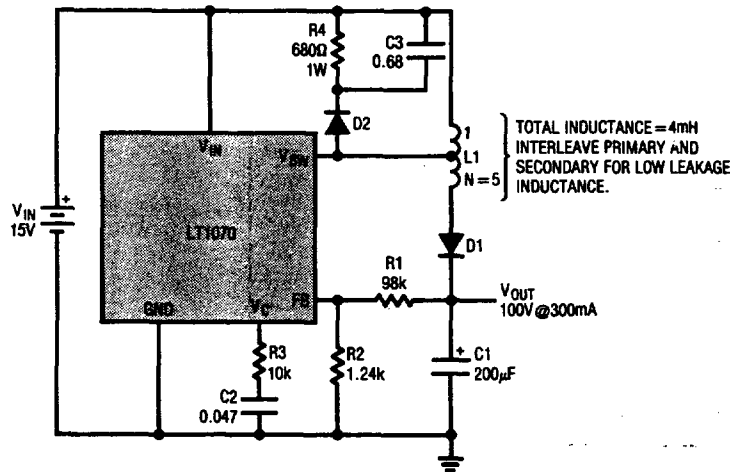

Current Boosted Boost Converter

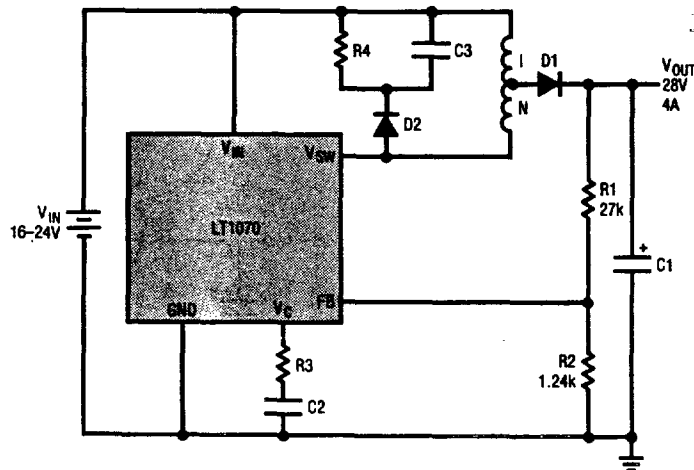

5

TYPICAL APPLICATIONS

Negative Buck Converter

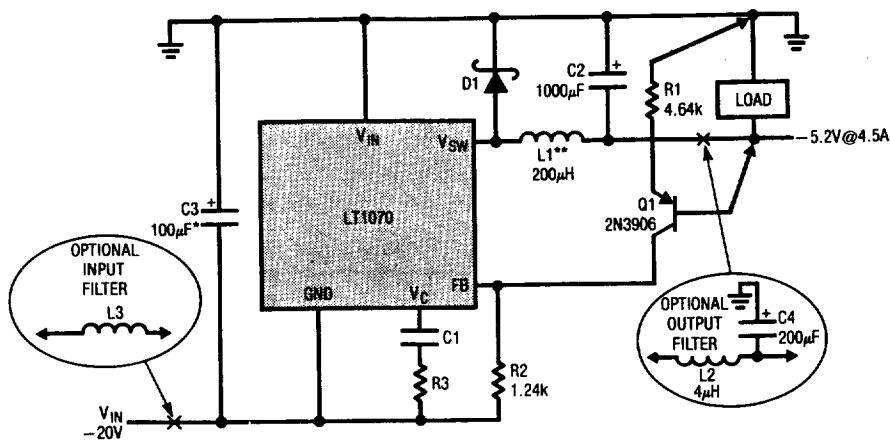

*REQUIRED IF INPUT LEADS ≥ 2 "
 **PULSE ENGINEERING 92113

Negative Current Boosted Buck Converter

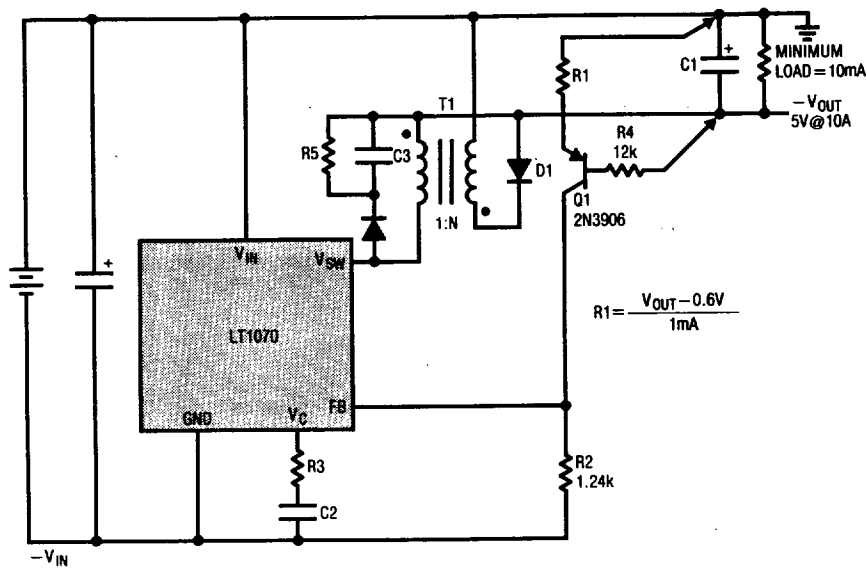

$$R1 = \frac{V_{OUT} - 0.6V}{1mA}$$

Positive Buck Converter

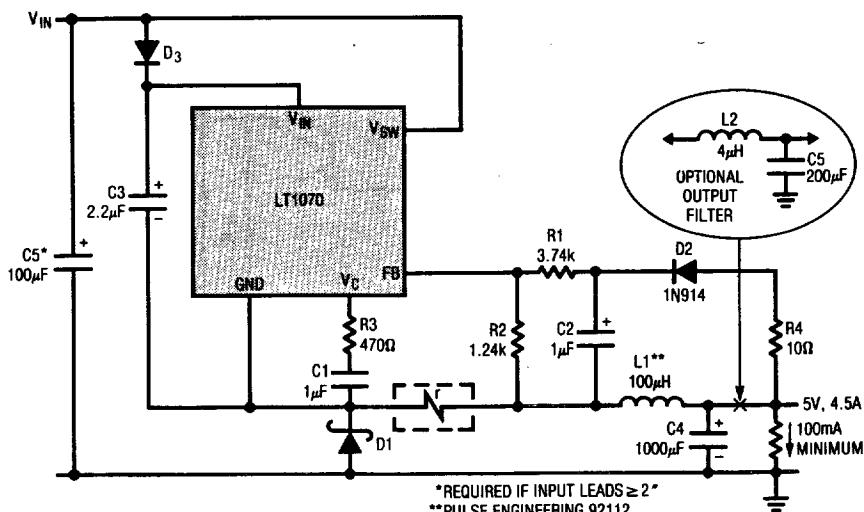

*REQUIRED IF INPUT LEADS ≥ 2 "
 **PULSE ENGINEERING 92112

TYPICAL APPLICATIONS

Negative Boost Regulator

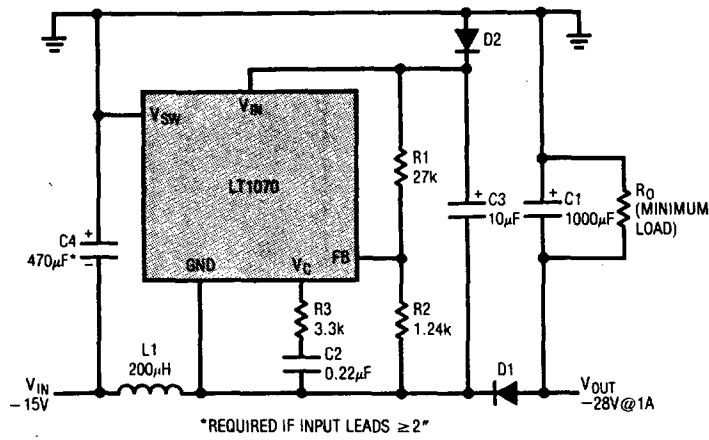

Driving High Voltage NPN

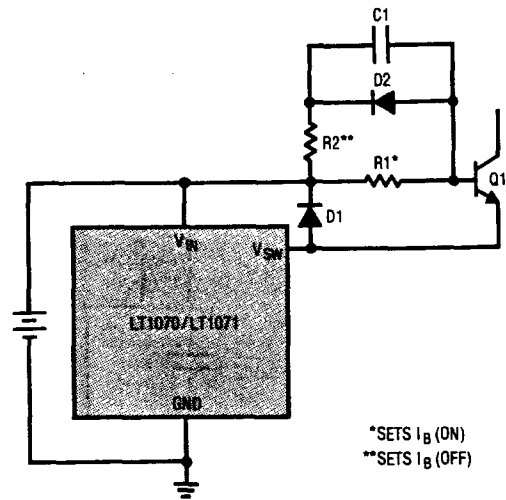

Negative Input-Negative Output Flyback Converter

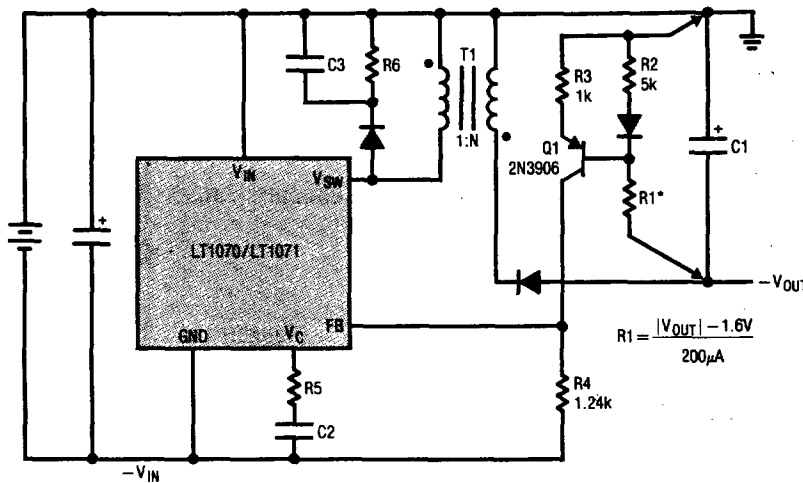

Forward Converter

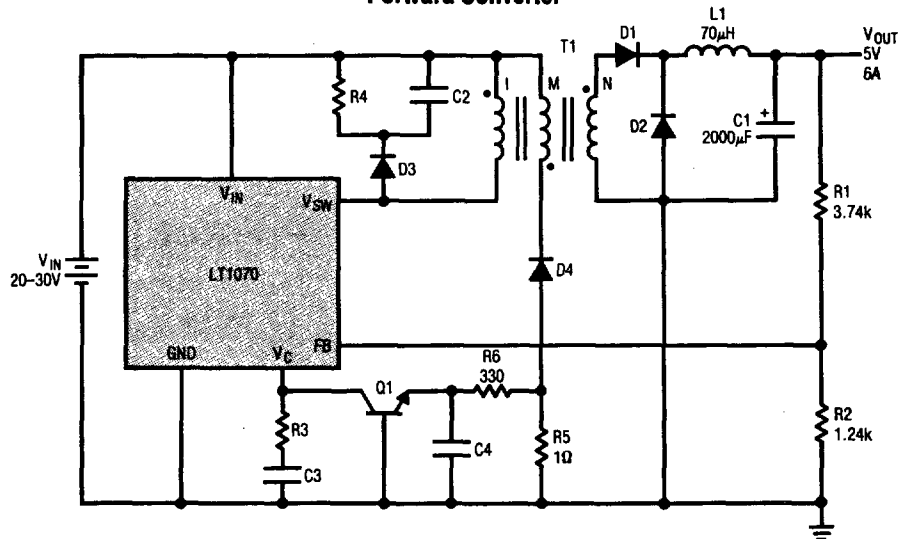

5

TYPICAL APPLICATIONS

Positive Current Boosted Buck Converter

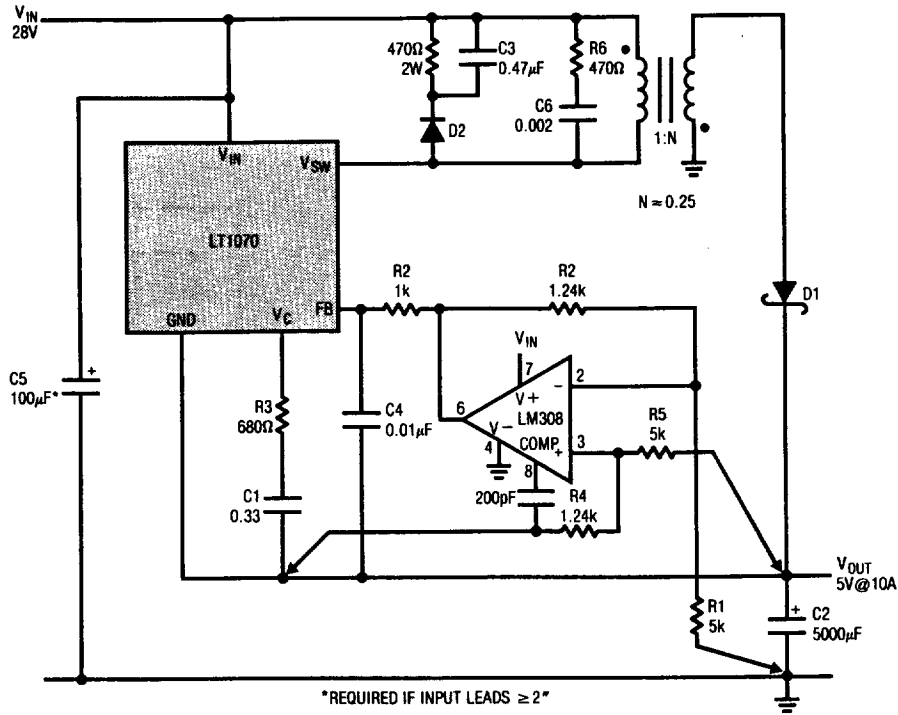

PACKAGE DESCRIPTION Dimensions in inches (millimeters) unless otherwise noted.

TO-3 Type Metal Can (Steel) K Package

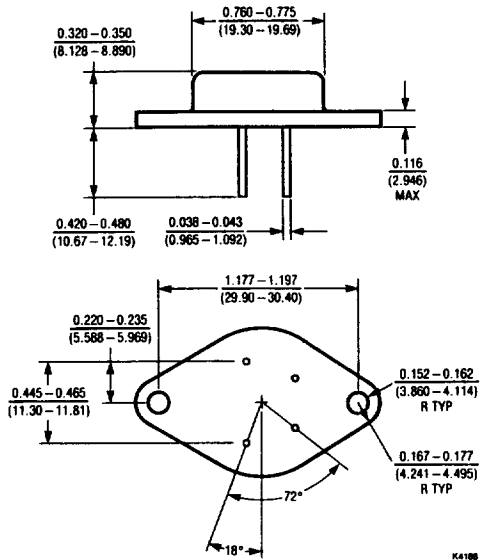

TO-220 Type Plastic T Package

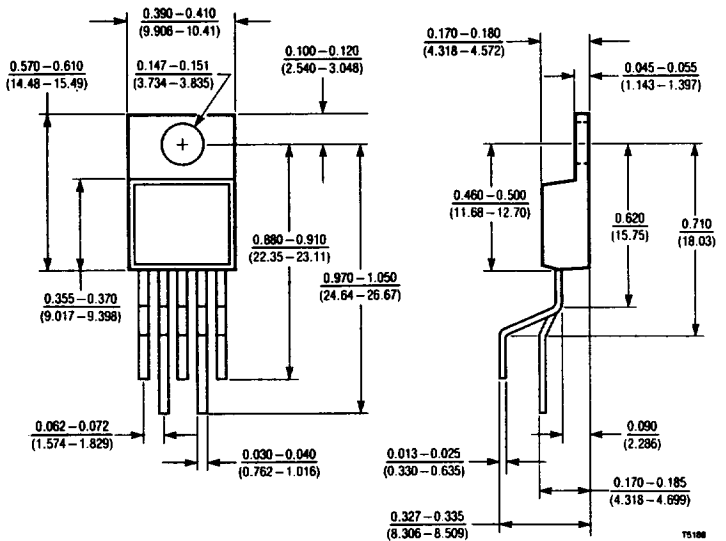

	T _{JMAX}	θ _{JC}	θ _{JA}
LT1070MK, LT1070HVMK	150°C	2°C/W	35°C/W
LT1070CK, LT1070HVCK	100°C	2°C/W	35°C/W
LT1071MK, LT1071HVMK	150°C	4°C/W	35°C/W
LT1071CK, LT1071HVCK	100°C	4°C/W	35°C/W

	T _{JMAX}	θ _{JC}	θ _{JA}
LT1070CT, LT1070HVCT	100°C	2°C/W	75°C/W
LT1071CT, LT1071HVCT	100°C	4°C/W	75°C/W