

(5340 × 5340) PIXELS × 3 + 2670 PIXELS × 3 COLOR CCD LINEAR IMAGE SENSOR

DESCRIPTION

The μ PD8891 is a color CCD (Charge Coupled Device) linear image sensor which changes optical images to electrical signal and has the function of color separation.

The μ PD8891 has 3 rows of (5340+5340) staggered pixels, and each row has a dual-sided readout type of charge transfer register, and has 3 rows of 2670 pixels, and each row has a single-sided readout type of charge transfer register. And it has reset feed-through level clamp circuits and voltage amplifiers. Therefore, it is suitable for 1200 dpi/A4 color image scanners, color facsimiles and so on.

FEATURES

- Valid photocell : (5340+5340) pixels × 3 + 2670 pixels × 3
- Photocell pitch : 5.25 μ m (1200 dpi), 10.5 μ m (300 dpi)
- Photocell size : 5.25 × 5.25 μ m² (1200 dpi), 10.5 × 8 μ m² (300 dpi)
- Line spacing : [1200 dpi sensor]
52.5 μ m (10 lines) Red line - Green line, Green line - Blue line
10.5 μ m (2 lines) Odd line – Even line (for each color)
[300 dpi sensor]
42 μ m (4 lines) Red line - Green line, Green line - Blue line
- Color filter : Primary colors (red, green and blue), pigment filter (with light resistance 10⁷ lx·hour)
- Resolution : 48 dot/mm A4 (210 × 297 mm) size (shorter side)
1200 dpi US letter (8.5" × 11") size (shorter side)
- Drive clock level : CMOS output under 5 V operation
- Data rate : 5 MHz Max.
- Power supply : +12 V
- On-chip circuits : Reset feed-through level clamp circuits
Voltage amplifiers

ORDERING INFORMATION

Part Number	Package
μ PD8891CY	CCD linear image sensor 22-pin plastic DIP (10.16 mm (400))

The information in this document is subject to change without notice. Before using this document, please confirm that this is the latest version.

Not all products and/or types are available in every country. Please check with an NEC Electronics sales representative for availability and additional information.

BLOCK DIAGRAM

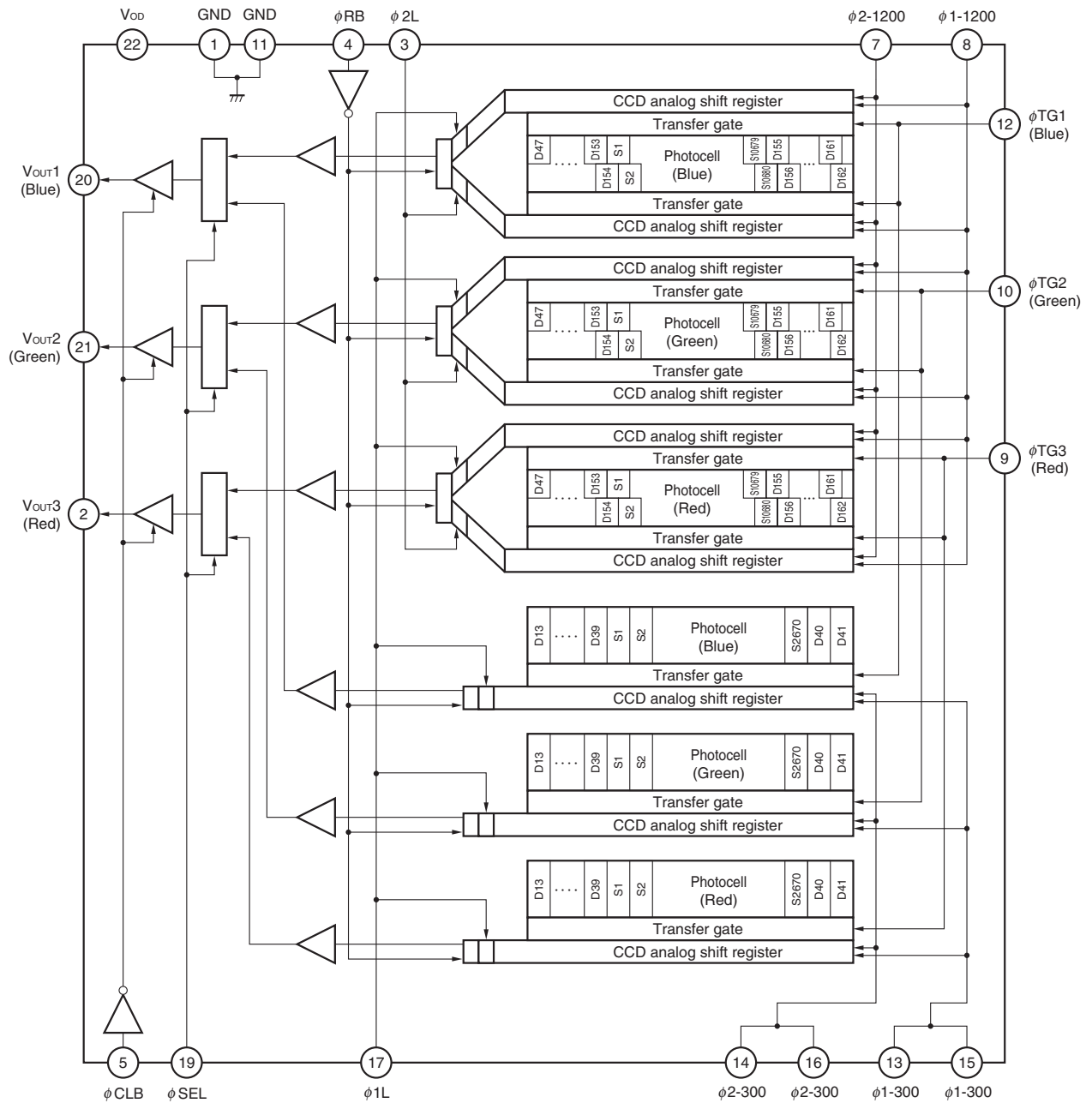

PHOTOCELL STRUCTURE DIAGRAM

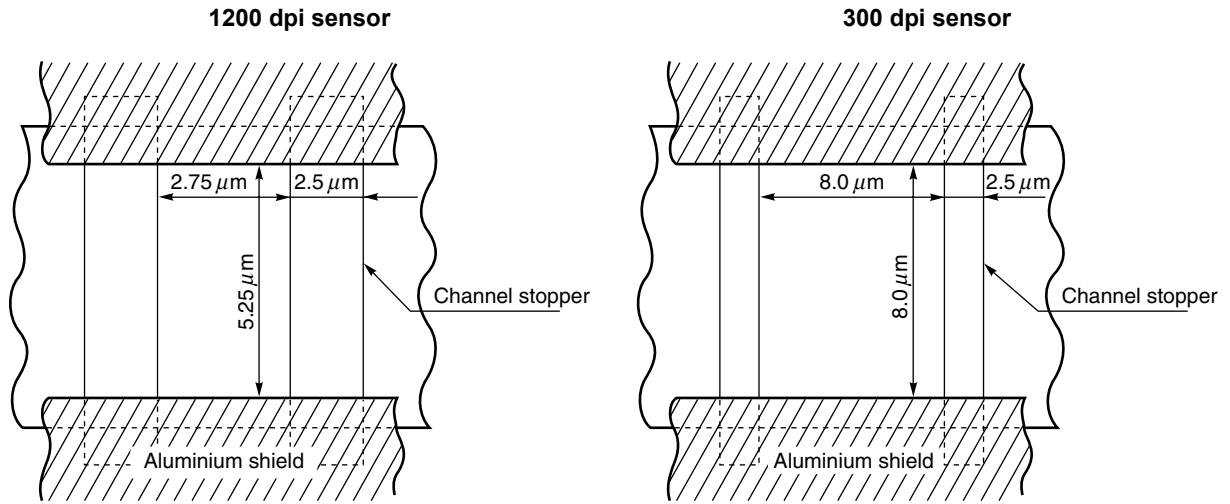

PHOTOCELL ARRAY STRUCTURE DIAGRAM 1 (Line Spacing)

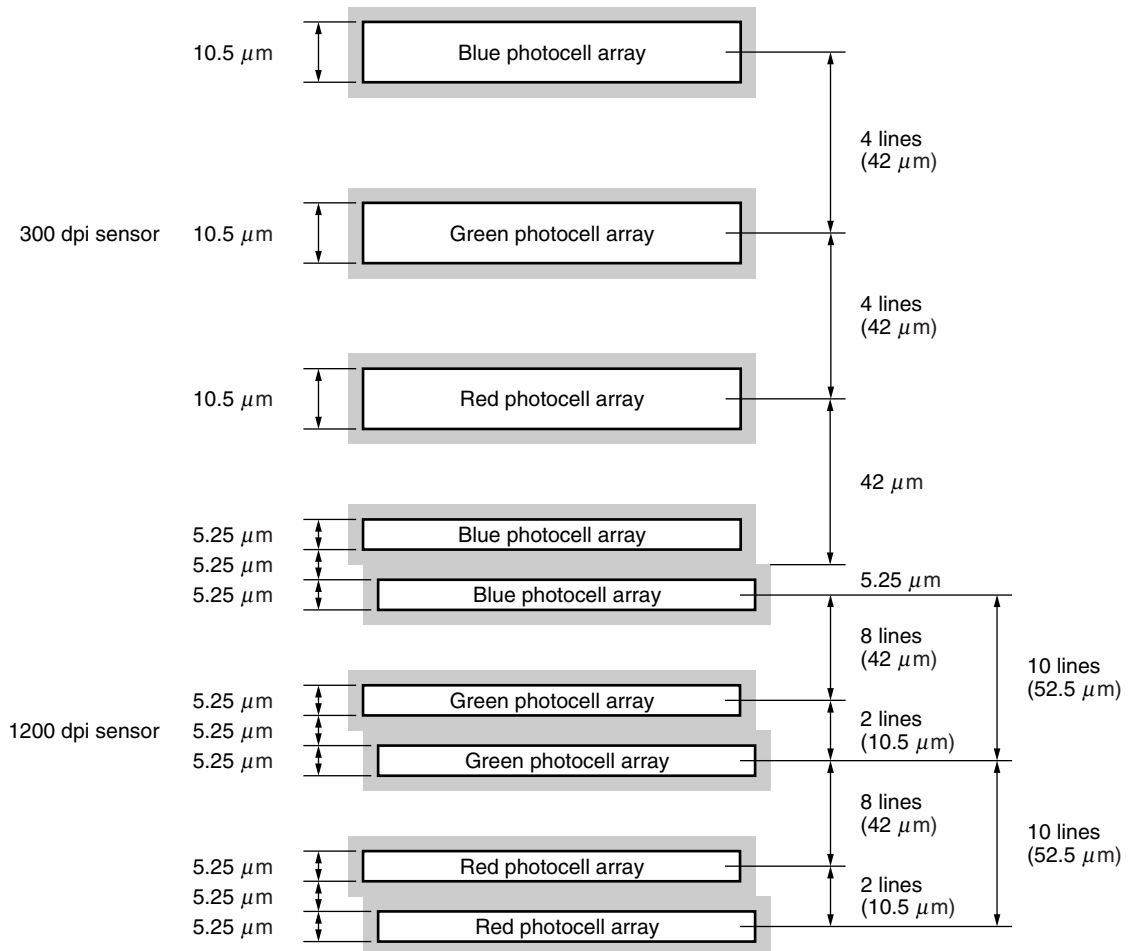

PHOTOCELL ARRAY STRUCTURE DIAGRAM 2 (The Relation of the Photocell Array)

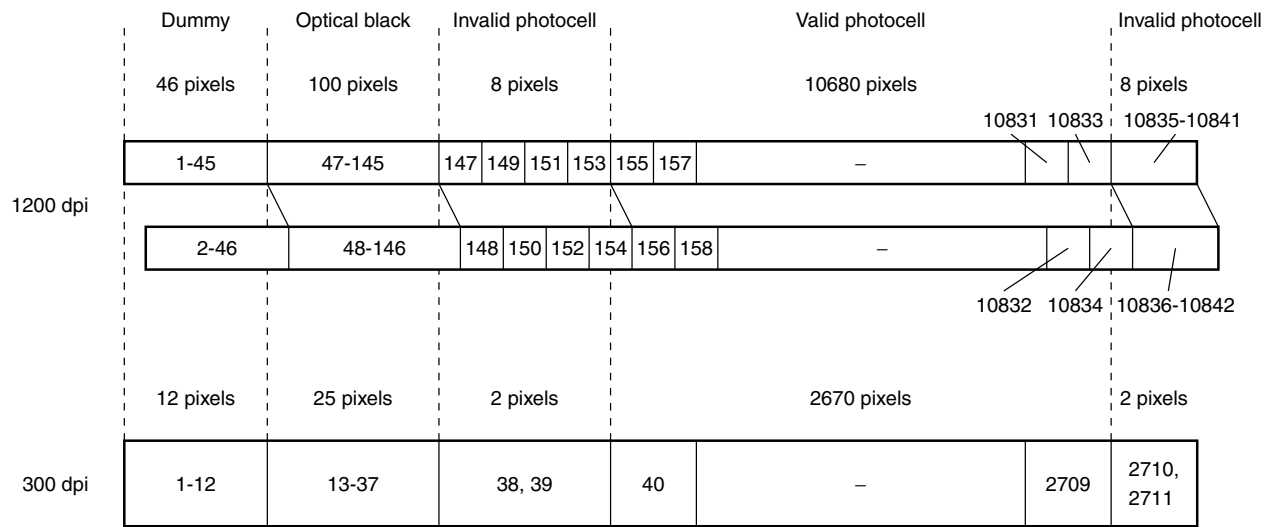

ABSOLUTE MAXIMUM RATINGS (T_A = +25°C)

Parameter	Symbol	Ratings	Unit
Output drain voltage	V _{OD}	-0.3 to +15	V
Shift register clock voltage	V _{φ 1-300} , V _{φ 1-1200} , V _{φ 1L} , V _{φ 2-300} , V _{φ 2-1200} , V _{φ 2L}	-0.3 to +8	V
Reset gate clock voltage	V _{φ RB}	-0.3 to +8	V
Reset feed-through level clamp clock voltage	V _{φ CLB}	-0.3 to +8	V
300/1200 dpi select signal voltage	V _{φ SEL}	-0.3 to +8	V
Transfer gate clock voltage	V _{φ TG1} to V _{φ TG3}	-0.3 to +8	V
Operating ambient temperature ^{Note}	T _A	0 to +60	°C
Storage temperature	T _{stg}	-40 to +70	°C

Note Use at the condition without dew condensation.

Caution Product quality may suffer if the absolute maximum rating is exceeded even momentarily for any parameter. That is, the absolute maximum ratings are rated values at which the product is on the verge of suffering physical damage, and therefore the product must be used under conditions that ensure that the absolute maximum ratings are not exceeded.

RECOMMENDED OPERATING CONDITIONS (T_A = +25°C)

Parameter	Symbol	Min.	Typ.	Max.	Unit
Output drain voltage	V _{OD}	11.4	12.0	12.6	V
Shift register clock high level	V _{φ 1-300H} , V _{φ 1-1200H} , V _{φ 1LH} , V _{φ 2-300H} , V _{φ 2-1200H} , V _{φ 2LH}	4.75	5.0	5.25	V
Shift register clock low level	V _{φ 1-300L} , V _{φ 1-1200L} , V _{φ 1LL} , V _{φ 2-300L} , V _{φ 2-1200L} , V _{φ 2LL}	-0.3	0	+0.25	V
Reset gate clock high level	V _{φ RBH}	4.5	5.0	5.5	V
Reset gate clock low level	V _{φ RBL}	-0.3	0	+0.5	V
Reset feed-through level clamp clock high level	V _{φ CLBH}	4.5	5.0	5.5	V
Reset feed-through level clamp clock low level	V _{φ CLBL}	-0.3	0	+0.5	V
300/1200 dpi select signal high level	V _{φ SELH}	4.5	5.0	5.5	V
300/1200 dpi select signal low level	V _{φ SELL}	-0.3	0	+0.5	V
Transfer gate clock high level	V _{φ TG1H} to V _{φ TG3H}	4.75	V _{φ 1-300H} , V _{φ 1-1200H} ^{Note}	V _{φ 1-300H} , V _{φ 1-1200H} ^{Note}	V
Transfer gate clock low level	V _{φ TG1L} to V _{φ TG3L}	-0.3	0	+0.15	V
Data rate	f _{φ RB}	-	2.0	5.0	MHz

Note When Transfer gate clock high level (V_{φ TG1H} to V_{φ TG3H}) is higher than shift register clock high level (V_{φ 1-300H}, V_{φ 1-1200H}), image lag can increase.

ELECTRICAL CHARACTERISTICS

$T_A = +25^\circ\text{C}$, $V_{OD} = 12\text{ V}$, data rate ($f_{\phi\text{RB}}$) = 2 MHz, storage time = 11.0 ms, input signal clock = 5 V_{p-p},
light source : 3200 K halogen lamp + C-500S (infrared cut filter, t = 1 mm) + HA-50 (heat absorbing filter, t = 3 mm)

Parameter		Symbol	Test Conditions	Min.	Typ.	Max.	Unit
Saturation voltage		V _{sat}	300 dpi	2.5	2.7	–	V
			1200 dpi	2.0	2.4	–	V
Saturation exposure	Red	SER	300 dpi	–	0.167	–	lx•s
			1200 dpi	–	0.445	–	lx•s
	Green	SEG	300 dpi	–	0.176	–	lx•s
			1200 dpi	–	0.470	–	lx•s
	Blue	SEB	300 dpi	–	0.274	–	lx•s
			1200 dpi	–	0.732	–	lx•s
Photo response non-uniformity		PRNU	V _{OUT} = 1.0 V	–	6	20	%
Average dark signal		ADS	Light shielding 300 dpi	–	0.4	4.0	mV
			Light shielding 1200 dpi	–	0.2	2.0	mV
Dark signal non-uniformity		DSNU	Light shielding 300 dpi	–	4.0	12.0	mV
			Light shielding 1200 dpi	–	2.0	6.0	mV
Power consumption		P _w		–	300	480	mW
Output impedance		Z _o		–	0.4	1.0	kΩ
Response	Red	R _R	300 dpi	11.32	16.17	21.02	V/lx•s
			1200 dpi	3.77	5.39	7.01	V/lx•s
	Green	R _G	300 dpi	10.73	15.33	19.93	V/lx•s
			1200 dpi	3.58	5.11	6.64	V/lx•s
	Blue	R _B	300 dpi	6.89	9.84	12.79	V/lx•s
			1200 dpi	2.30	3.28	4.26	V/lx•s
Offset level ^{Note 1}		V _{OS}		4.5	6.0	7.5	V
Image lag		IL	V _{OUT} = 1.0 V	–	3.0	7.0	%
Output fall delay time ^{Note 2}		t _d	V _{OUT} = 1.0 V	–	25	–	ns
Total transfer efficiency		TTE	V _{OUT} = 1.0 V, data rate = 5 MHz	92	98	–	%
Register imbalance		RI	V _{OUT} = 1.0 V (1200 dpi)	–	1.0	4.0	%
Response peak	Red			–	630	–	nm
	Green			–	540	–	nm
	Blue			–	460	–	nm
Dynamic range		DR1	V _{sat} /DSNU 300 dpi	–	675	–	times
			V _{sat} /DSNU 1200 dpi	–	1200	–	times
		DR2	V _{sat} /σCDS 300 dpi	–	2700	–	times
			V _{sat} /σCDS 1200 dpi	–	2400	–	times
Reset feed-through noise ^{Note 1}		RFTN	Light shielding	–2000	–500	+1000	mV
Random noise (CDS)		σCDS	Light shielding	–	1.0	–	mV

Notes 1. Refer to **TIMING CHART 2–1 to 2–8**.

2. When the fall time of φ1L or φ2L (t1', t2') is the Typ. value (refer to **TIMING CHART 2–1 to 2–8**).

INPUT PIN CAPACITANCE (T_A = +25°C, V_{OD} = 12 V)

Parameter	Symbol	Pin name	Pin No.	Min.	Typ.	Max.	Unit
Shift register clock pin capacitance 1	C _{φ 1-300}	φ 1-300	13	–	250	–	pF
			15	–	250	–	pF
	C _{φ 1-1200}	φ 1-1200	8	–	850	–	pF
Shift register clock pin capacitance 2	C _{φ 2-300}	φ 2-300	14	–	300	–	pF
			16	–	300	–	pF
	C _{φ 2-1200}	φ 2-1200	7	–	850	–	pF
Last stage sift reset gate clock pin capacitance 1	C _{φ 1L}	φ 1L	17	–	15	–	pF
Last stage sift reset gate clock pin capacitance 2	C _{φ 2L}	φ 2L	3	–	15	–	pF
Reset gate clock pin capacitance	C _{φ RB}	φ RB	4	–	15	–	pF
Reset feed-through level clamp clock pin capacitance	C _{φ CLB}	φ CLB	5	–	15	–	pF
300/1200 dpi select signal pin capacitance	C _{φ SEL}	φ SEL	19	–	15	–	pF
Transfer gate clock pin capacitance	C _{φ TG}	φ TG1	12	–	200	–	pF
		φ TG2	10	–	200	–	pF
		φ TG3	9	–	200	–	pF

300/600/1200 MODE

Mode	Description	φ SEL	300 dpi data	φ 1-300, φ 2-300	1200 dpi data	φ 1-1200, φ 2-1200
1	300 dpi only	High	Use	Clocked	Flush ^{Note 2}	Clocked
2	600 dpi only ^{Note 1}	Low	Flush ^{Note 2}	Clocked	Use 1 line	Clocked
3	1200 dpi only	Low	Flush ^{Note 2}	Clocked	Use	Clocked

Notes 1. For 600 dpi mode, the reset pulse is extended to allow second line's charge to dump immediately to DC level.

2. Flush means that data is continuously sunk via reset gate.

TIMING CHART 1-1 (1200 dpi, for each color)

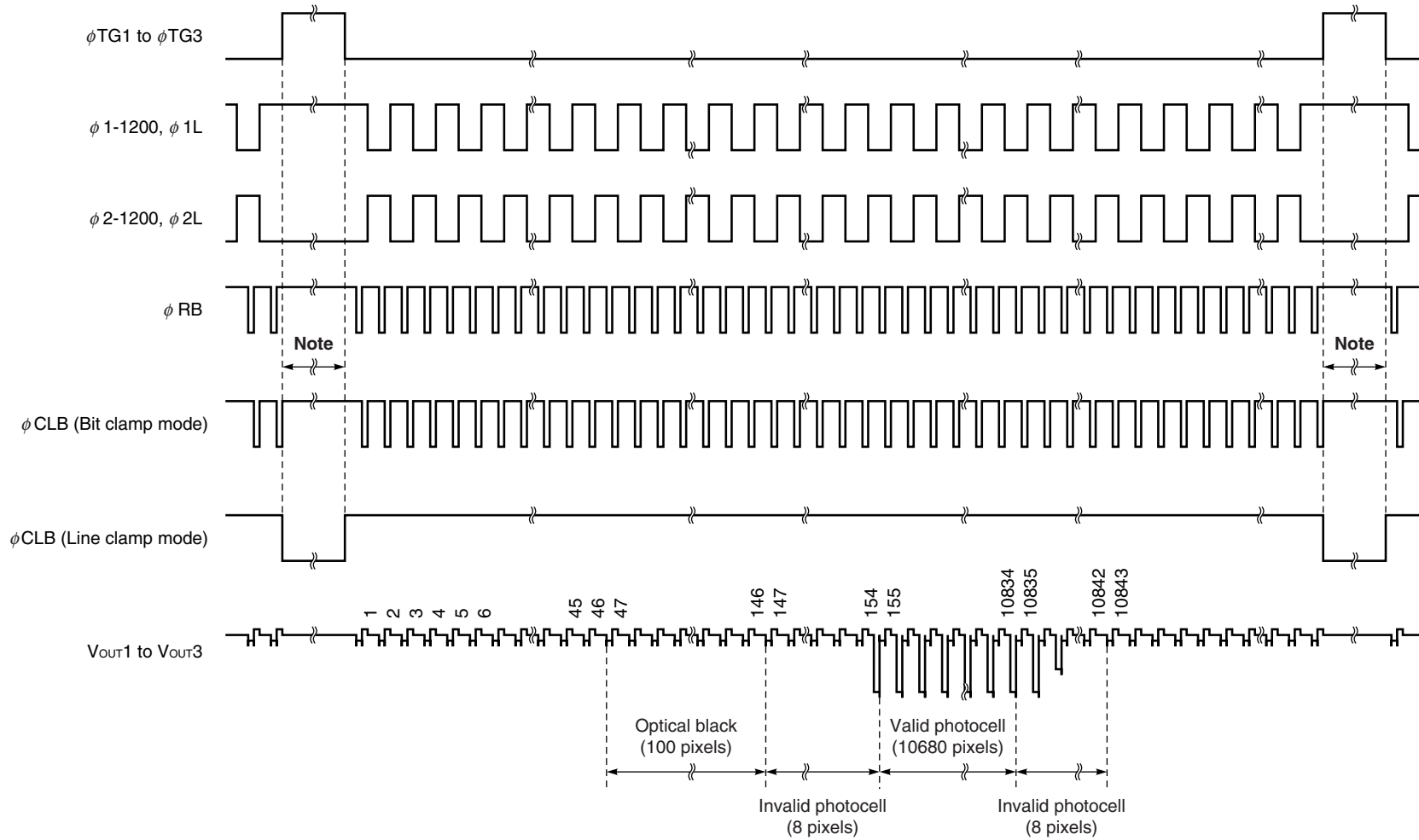

Note Set the ϕ RB pulse and ϕ CLB pulse (bit clamp mode) to high level during the ϕ TG1 to ϕ TG3 pulse.
 And set the ϕ RB pulse to high level while the ϕ CLB pulse is low level at line clamp mode.

Remark Inverse pulse of the ϕ TG1 to ϕ TG3 can be used as ϕ CLB at line clamp mode.

TIMING CHART 1-2 (600 dpi, even pixel, for each color)

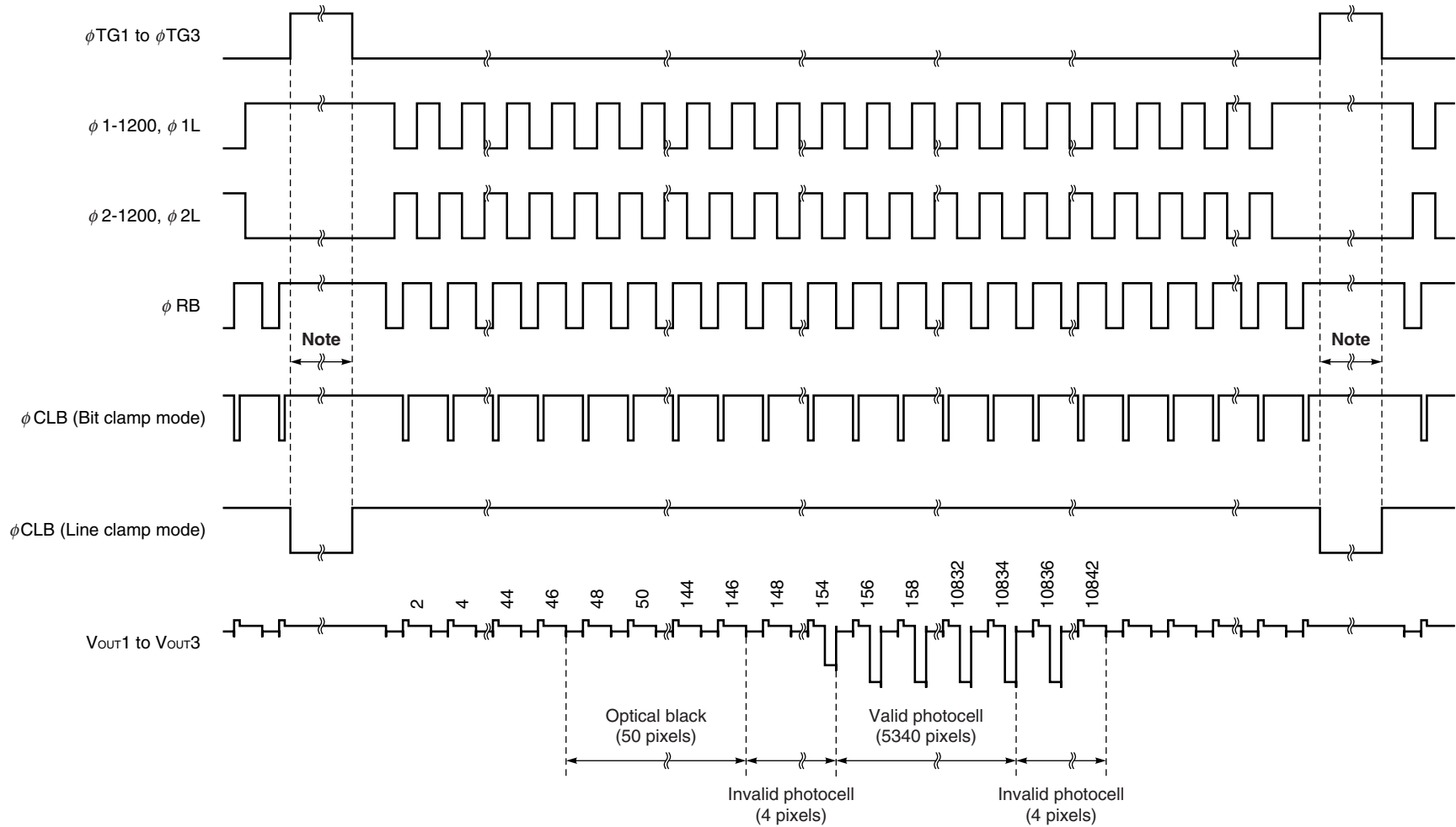

Note Set the ϕ RB pulse and ϕ CLB pulse (bit clamp mode) to high level during the ϕ TG1 to ϕ TG3 pulse.
And set the ϕ RB pulse to high level while the ϕ CLB pulse is low level at line clamp mode.

Remark Inverse pulse of the ϕ TG1 to ϕ TG3 can be used as ϕ CLB at line clamp mode.

TIMING CHART 1-3 (600 dpi, odd pixel, for each color)

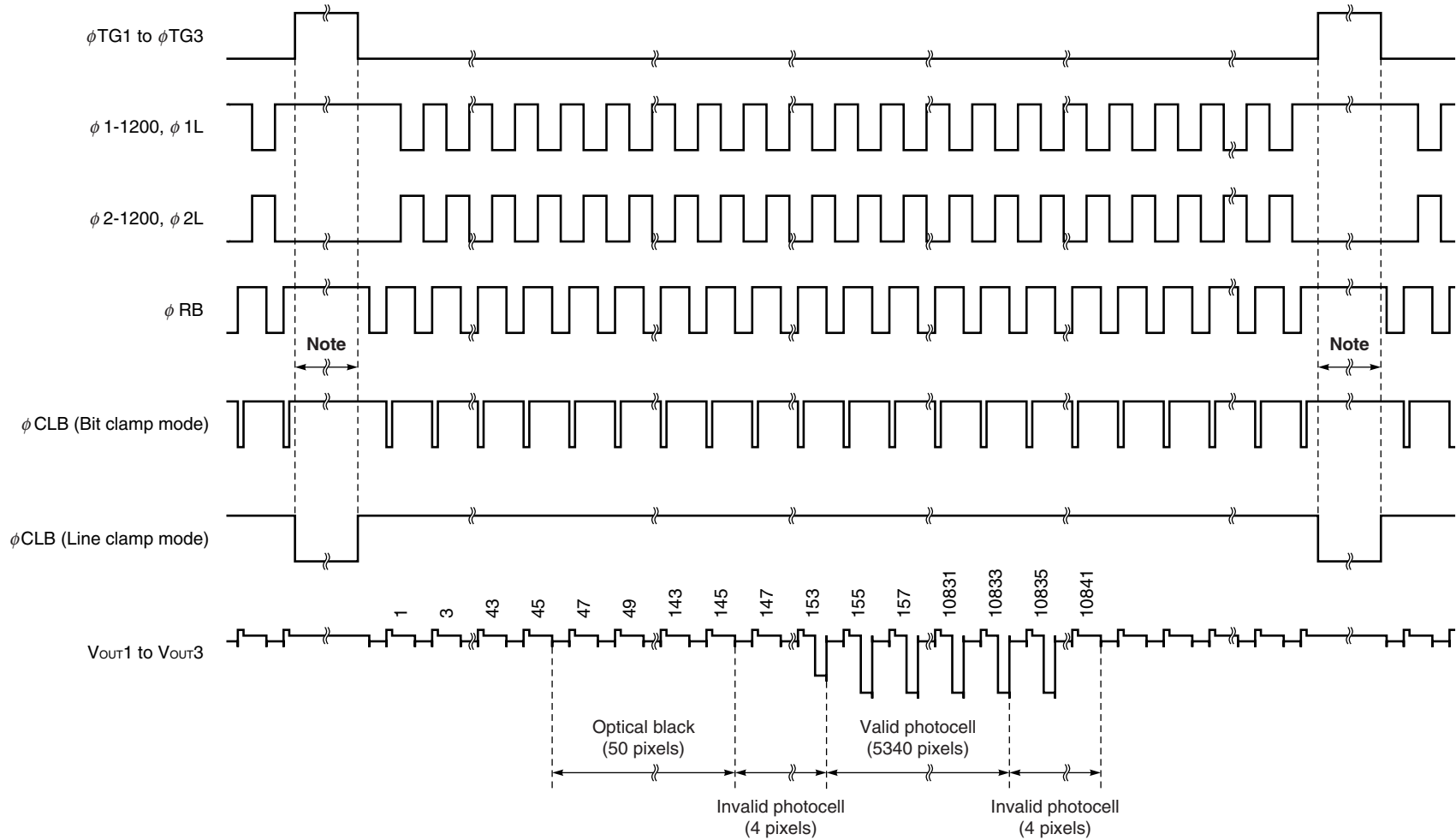

Note Set the ϕ RB pulse and ϕ CLB pulse (bit clamp mode) to high level during the ϕ TG1 to ϕ TG3 pulse.
And set the ϕ RB pulse to high level while the ϕ CLB pulse is low level at line clamp mode.

Remark Inverse pulse of the ϕ TG1 to ϕ TG3 can be used as ϕ CLB at line clamp mode.

TIMING CHART 1-4 (300 dpi, for each color)

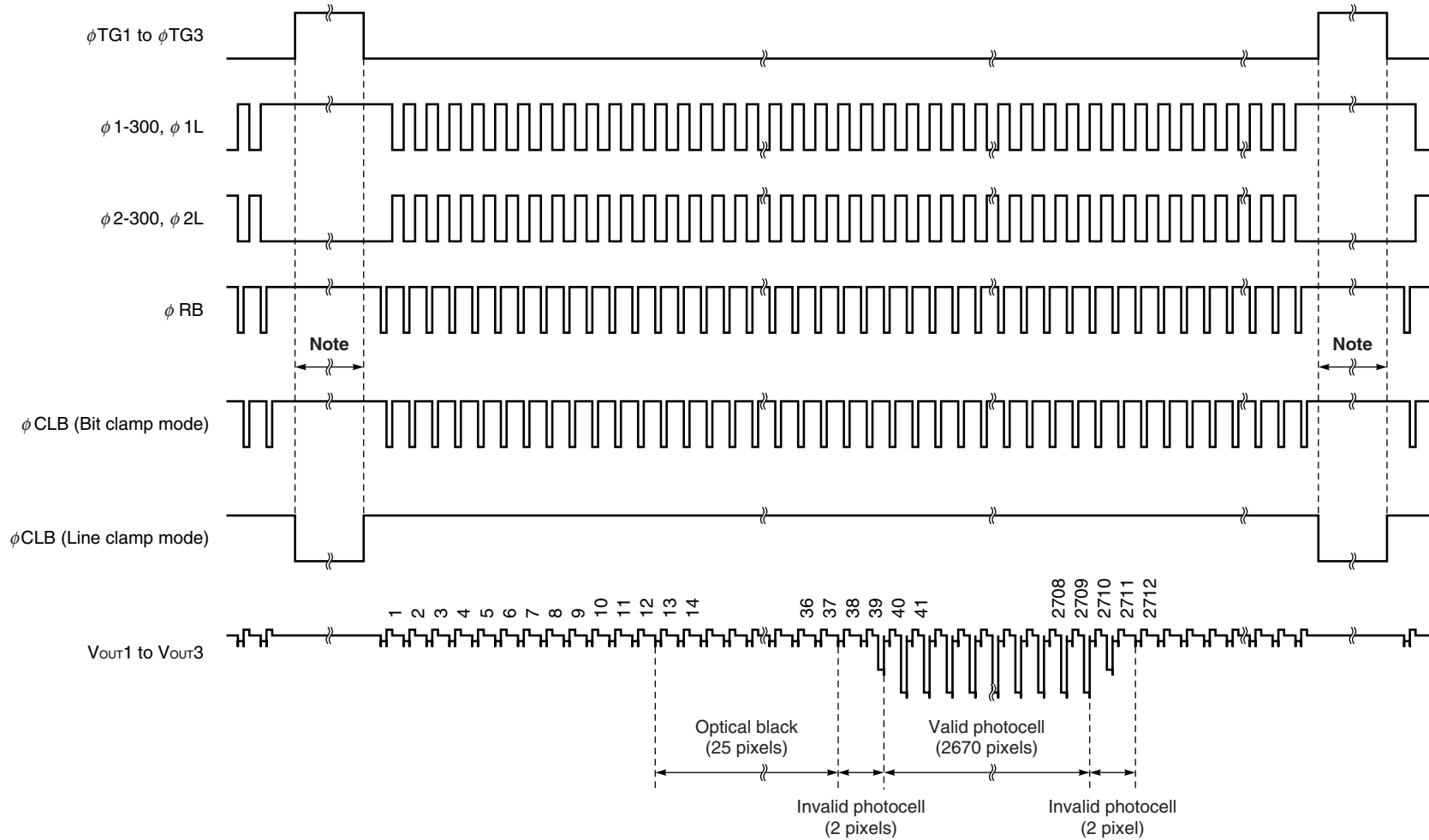

Note Set the ϕRB pulse and ϕCLB pulse (bit clamp mode) to high level during the $\phi TG1$ to $\phi TG3$ pulse.
 And set the ϕRB pulse to high level while the ϕCLB pulse is low level at line clamp mode.

Remark Inverse pulse of the $\phi TG1$ to $\phi TG3$ can be used as ϕCLB at line clamp mode.

TIMING CHART 2-3 (600 dpi, even pixel, bit clamp mode, for each color)

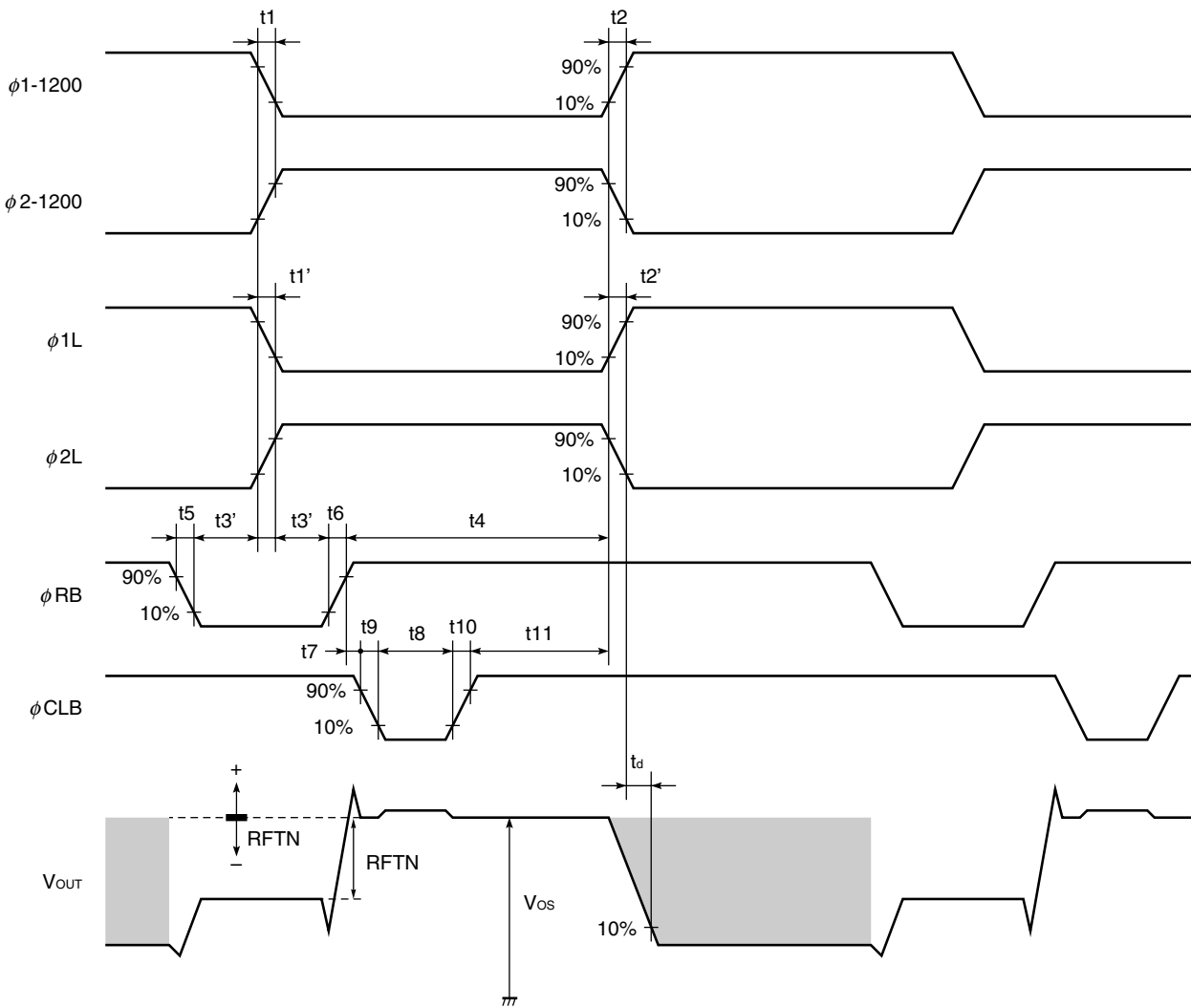

Symbol	Min.	Typ.	Max.	Unit
t_1, t_2	0	25	–	ns
t_1', t_2'	0	5	–	ns
t_3'	50	100	–	ns
t_4	50	370	–	ns
t_5, t_6	0	5	–	ns
t_7	-5 ^{Note}	+25	–	ns
t_8	100	200	–	ns
t_9, t_{10}	0	5	–	ns
t_{11}	5	100	–	ns

Note Min. of t_7 shows that the ϕRB and ϕCLB overlap each other.

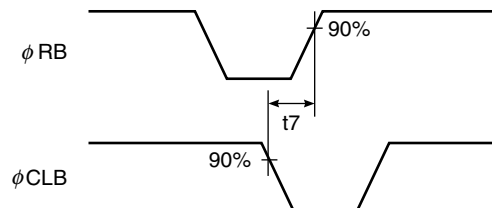

TIMING CHART 2-5 (600 dpi, odd pixel, bit clamp mode, for each color)

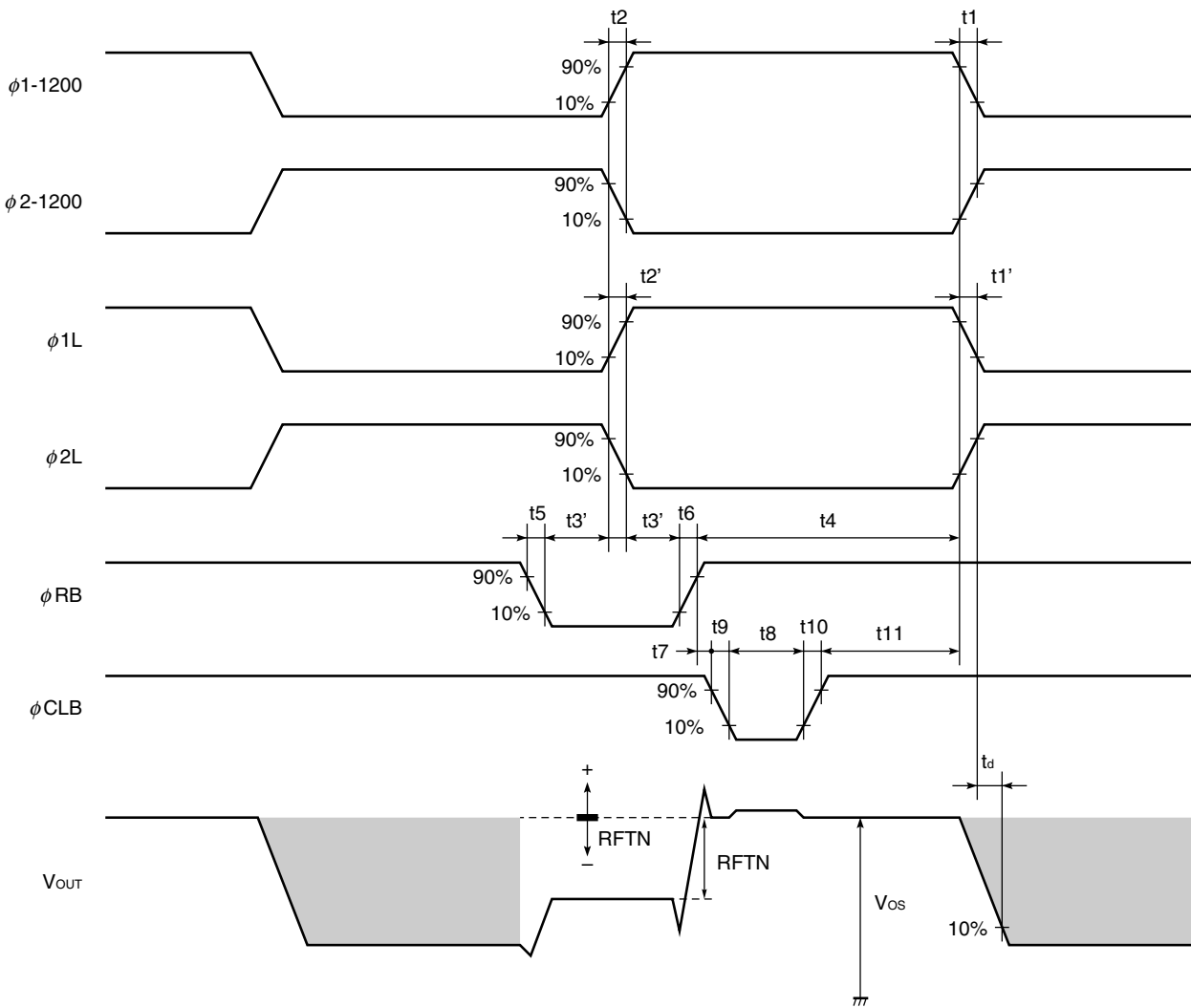

Symbol	Min.	Typ.	Max.	Unit
t1, t2	0	25	–	ns
t1', t2'	0	5	–	ns
t3'	50	100	–	ns
t4	50	370	–	ns
t5, t6	0	5	–	ns
t7	-5 ^{Note}	+25	–	ns
t8	100	200	–	ns
t9, t10	0	5	–	ns
t11	5	100	–	ns

Note Min. of t7 shows that the ϕRB and ϕCLB overlap each other.

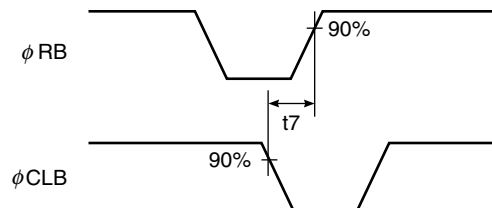

TIMING CHART 2-7 (300 dpi, bit clamp mode, for each color)

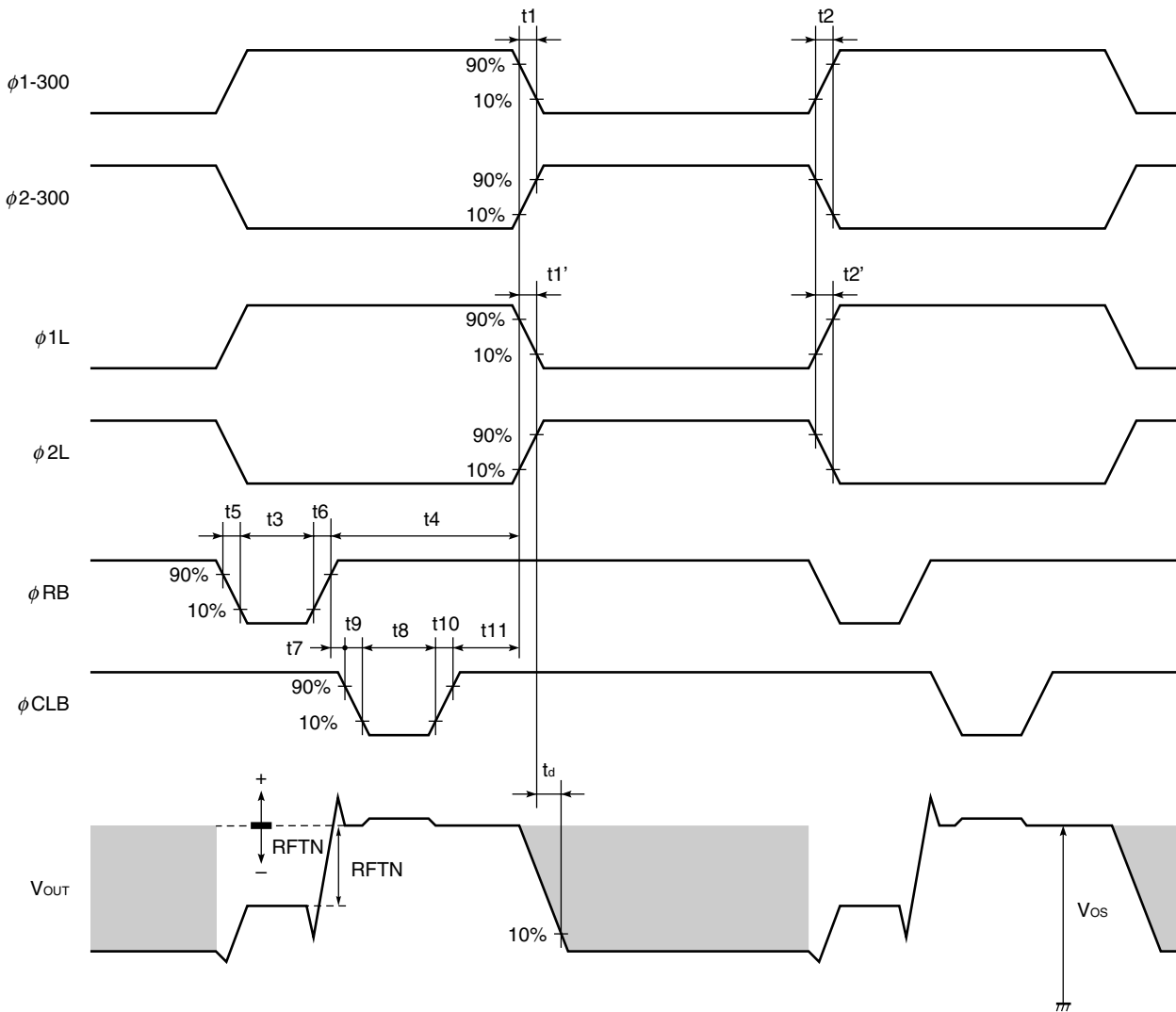

Symbol	Min.	Typ.	Max.	Unit
t_1, t_2	0	25	–	ns
t_1', t_2'	0	5	–	ns
t_3	20	50	–	ns
t_4	50	150	–	ns
t_5, t_6	0	5	–	ns
t_7	-5 ^{Note}	+25	–	ns
t_8	20	50	–	ns
t_9, t_{10}	0	5	–	ns
t_{11}	5	25	–	ns

Note Min. of t_7 shows that the ϕRB and ϕCLB overlap each other.

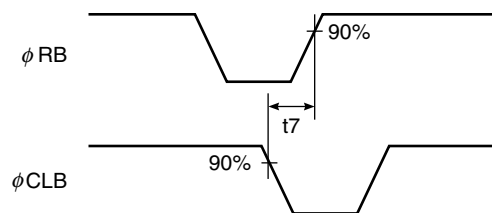

TIMING CHART 2-8 (300 dpi, line clamp mode, for each color)

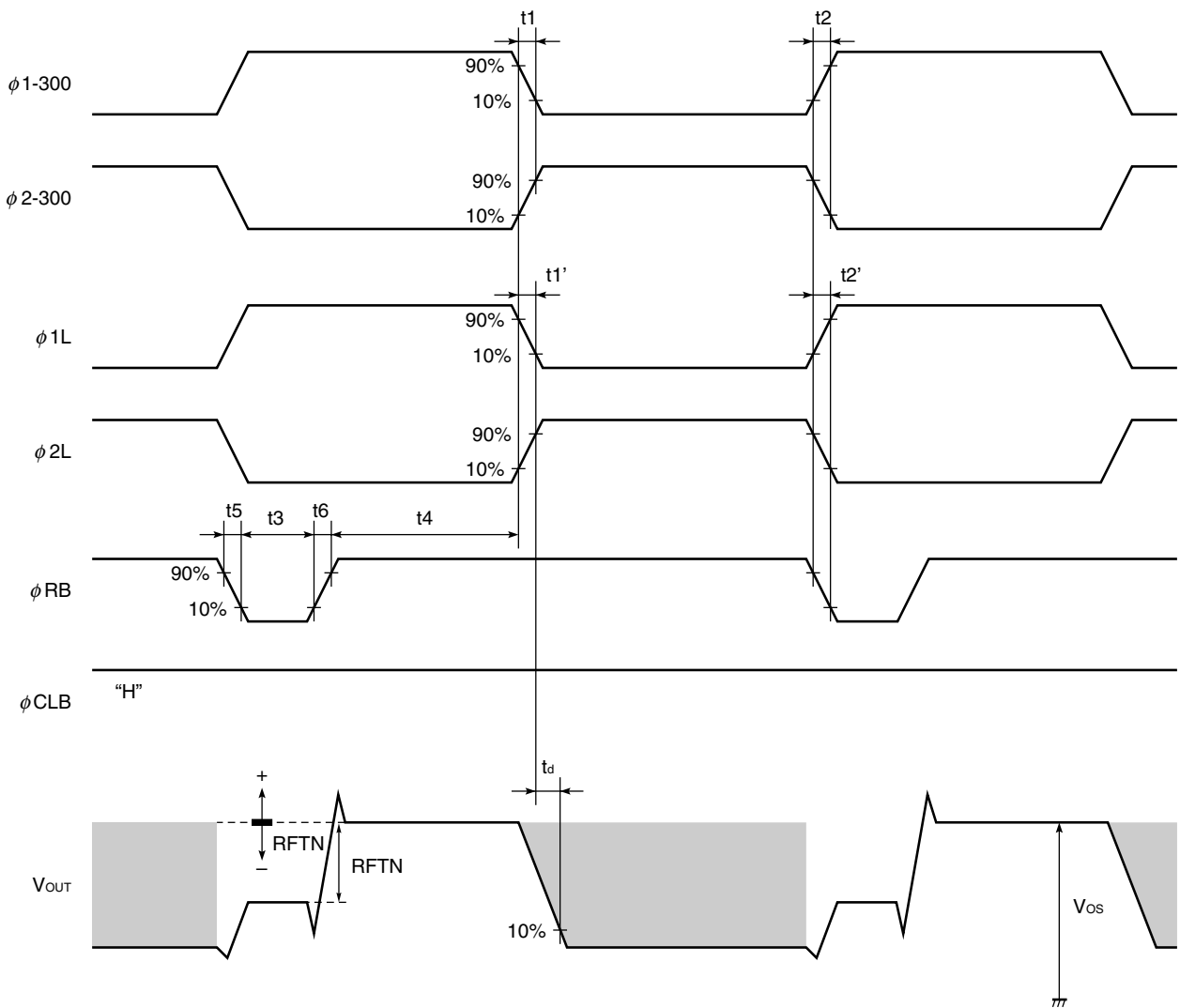

Symbol	Min.	Typ.	Max.	Unit
t1, t2	0	25	-	ns
t1', t2'	0	5	-	ns
t3	20	50	-	ns
t4	50	150	-	ns
t5, t6	0	5	-	ns

φTG1 to φTG3, φ1, φ2 TIMING CHART

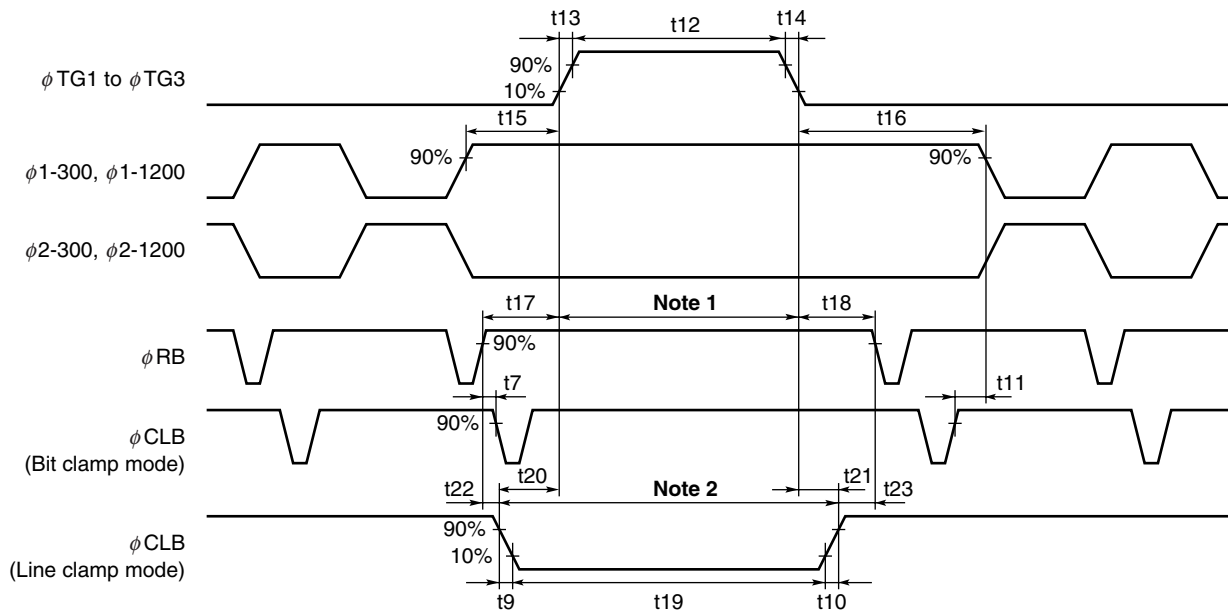

Symbol	Min.	Typ.	Max.	Unit
t7	-5 Note 3	+25	-	ns
t9, t10	0	5	-	ns
t11	5	25	-	ns
t12	5000	10000	50000	ns
t13, t14	0	50	-	ns
t15, t16	900	1000	-	ns
t17, t18	200	400	-	ns
t19	t12	t12	50000	ns
t20, t21	0	50	-	ns
t22, t23	0	350	-	ns

- Notes**
1. Set the φRB pulse and φCLB pulse (bit clamp mode) to high level during this period.
 2. Set the φRB pulse to high level during this period.
 3. Min. of t7 shows that the φRB and φCLB overlap each other.

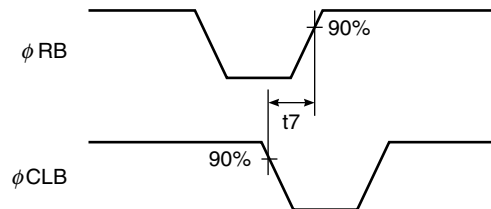

Remark Inverse pulse of the φTG1 to φTG3 can be used as φCLB.

ϕ 1-300, ϕ 2-300 cross points

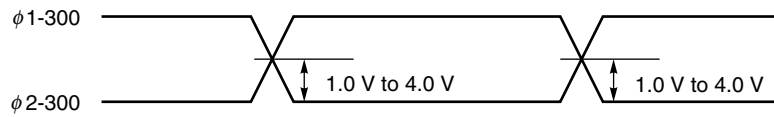

ϕ 1-1200, ϕ 2-1200 cross points

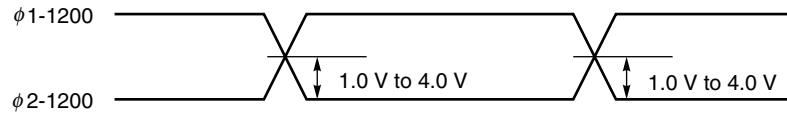

ϕ 1-300, ϕ 1-1200, ϕ 2L cross points

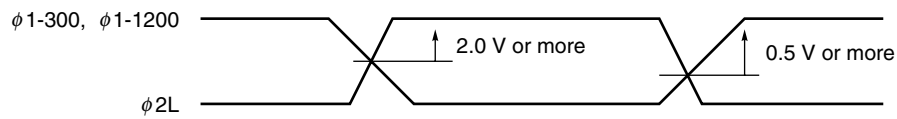

ϕ 2-300, ϕ 1-1200, ϕ 1L cross points

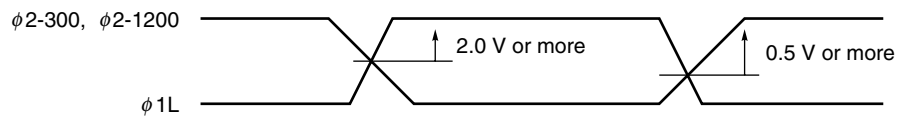

Remark Adjust cross points (ϕ 1-300, ϕ 2-300), (ϕ 1-1200, ϕ 2-1200), (ϕ 1-300, ϕ 1-1200, ϕ 2L) and (ϕ 2-300, ϕ 1-1200, ϕ 1L) with input resistance of each pin.

DEFINITIONS OF CHARACTERISTIC ITEMS

1. Saturation voltage : **V_{sat}**
Output signal voltage at which the response linearity is lost.
2. Saturation exposure : **SE**
Product of intensity of illumination (lx) and storage time (s) when saturation of output voltage occurs.
3. Photo response non-uniformity : **PRNU**
The output signal non-uniformity of all the valid pixels when the photosensitive surface is applied with the light of uniform illumination. This is calculated by the following formula.

$$PRNU (\%) = \frac{\Delta x}{\bar{x}} \times 100$$

Δx : maximum of $|x_j - \bar{x}|$

$$\bar{x} = \frac{\sum_{j=1}^{\text{Valid pixels}} x_j}{\text{Valid pixels}}$$

x_j : Output voltage of valid pixel number j

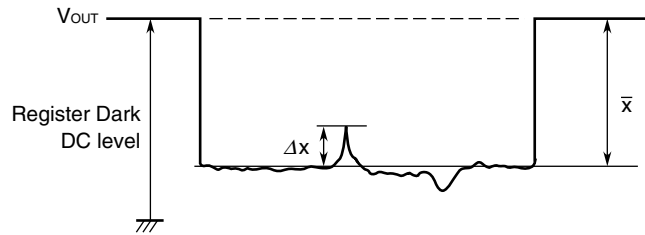

4. Average dark signal : **ADS**
Average output signal voltage of all the valid pixels at light shielding. This is calculated by the following formula.

$$ADS (mV) = \frac{\sum_{j=1}^{\text{Valid pixels}} d_j}{\text{Valid pixels}}$$

d_j : Dark signal of valid pixel number j

5. Dark signal non-uniformity : **DSNU**

Absolute maximum of the difference between ADS and voltage of the highest or lowest output pixel of all the valid pixels at light shielding. This is calculated by the following formula.

$$\text{DSNU (mV)} : \text{maximum of } |d_j - \text{ADS}|_{j=1 \text{ to valid pixels}}$$

d_j : Dark signal of valid pixel number j

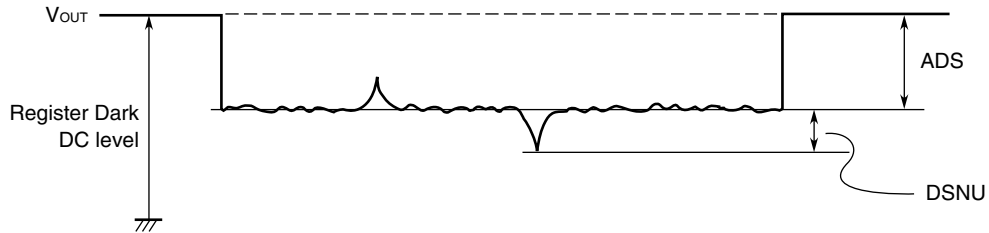

6. Output impedance : **Zo**

Impedance of the output pins viewed from outside.

7. Response : **R**

Output voltage divided by exposure ($I_x \cdot s$).

Note that the response varies with a light source (spectral characteristic).

8. Image lag : **IL**

The rate between the last output voltage and the next one after read out the data of a line.

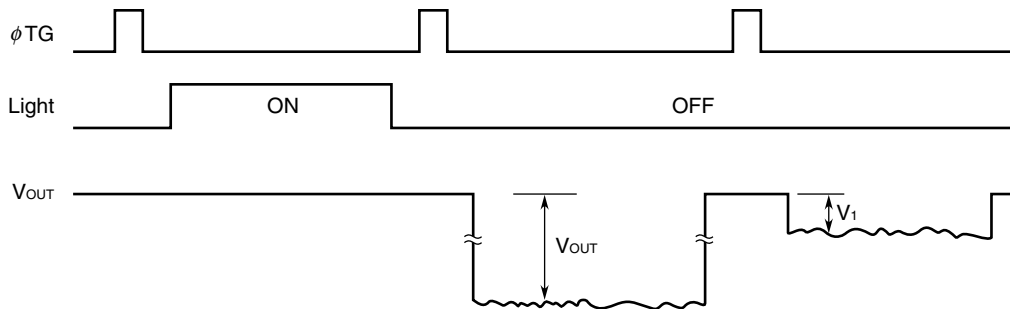

$$\text{IL (\%)} = \frac{V_1}{V_{\text{OUT}}} \times 100$$

9. Register Imbalance : **RI** (1200 dpi)

The rate of the difference between the averages of the output voltage of Odd and Even bits, against the average output voltage of all the valid pixels.

$$RI (\%) = \frac{\frac{2}{n} \left| \sum_{j=1}^{\frac{n}{2}} (V_{2j-1} - V_{2j}) \right|}{\frac{1}{n} \sum_{j=1}^n V_j} \times 100$$

n : Number of valid pixels
 V_j : Output voltage of each pixel

10. Random noise (CDS) : **σCDS**

Random noise σCDS is defined as the standard deviation of a valid pixel output signal with 100 times (=100 lines) data sampling at dark (light shielding). σCDS is calculated by the following procedure.

1. One valid photocell in one reading is fixed as measurement point.
2. The output level is measured during the reset feed-through period which is averaged over 100 ns to get “VD_i”.
3. The output level is measured during the Video Output time averaged over 100 ns to get “VO_i”.
4. The correlated double sampling output is defined by VCDS_i = VD_i – VO_i
5. Repeat the above procedure (1 to 4) for 100 times (= 100 lines).
6. Calculate the standard deviation σCDS using the following formula equation.

$$\sigma_{CDS} (mV) = \sqrt{\frac{\sum_{i=1}^{100} (VCDS_i - \bar{V})^2}{100}}, \quad \bar{V} = \frac{1}{100} \sum_{i=1}^{100} VCDS_i$$

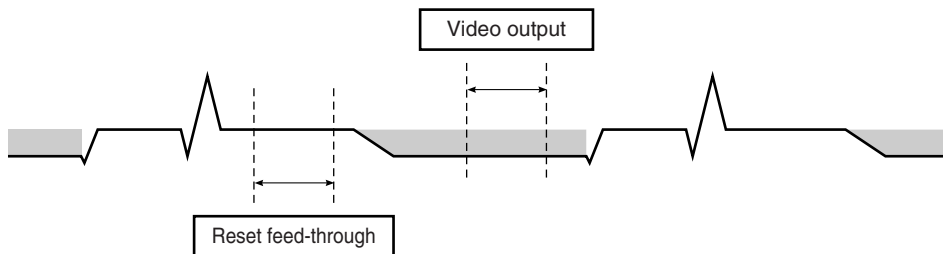

STANDARD CHARACTERISTIC CURVES (Reference Value)

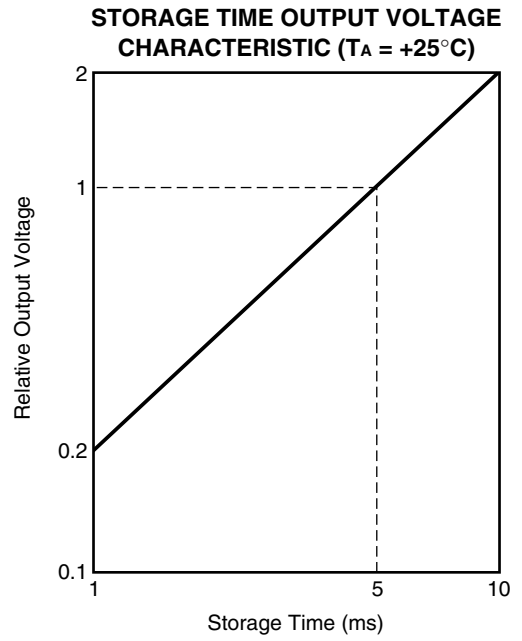
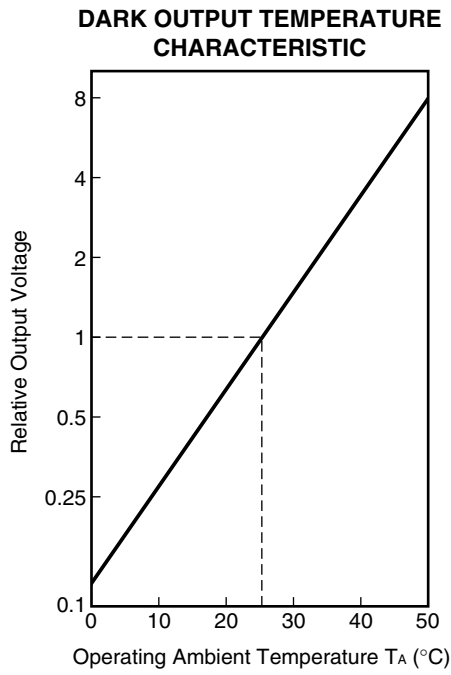

**TOTAL SPECTRAL RESPONSE CHARACTERISTICS
(without infrared cut filter and heat absorbing filter) ($T_A = +25^\circ\text{C}$)**

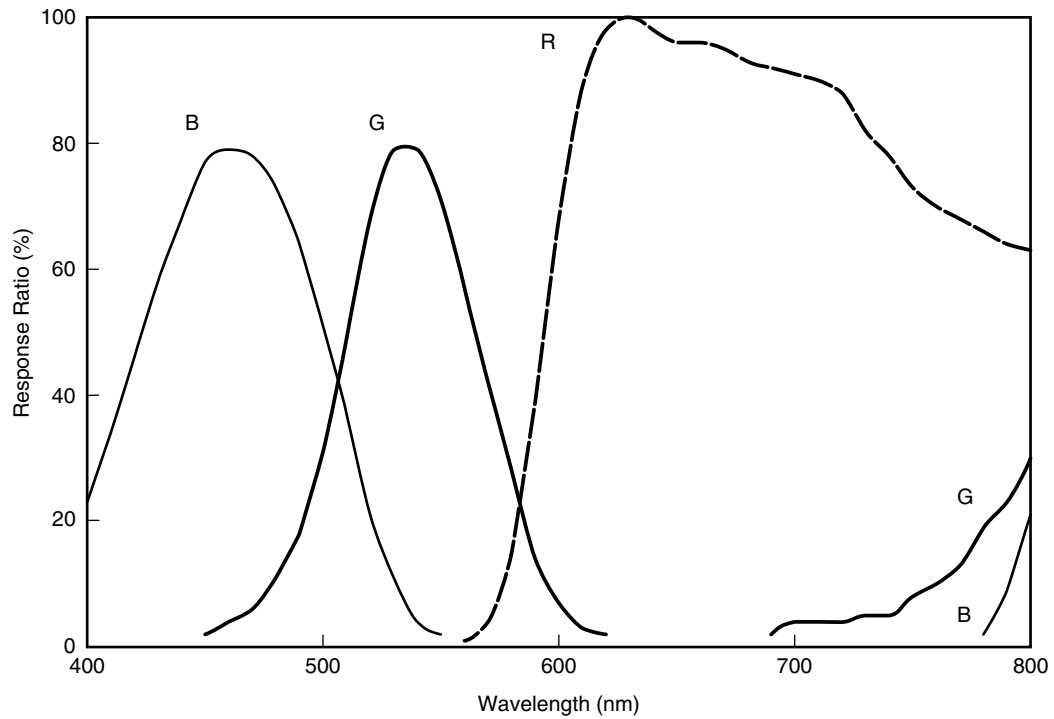

PACKAGE DRAWING

μPD8891CY
 CCD LINEAR IMAGE SENSOR 22-PIN PLASTIC DIP (10.16 mm (400))

(Unit : mm)

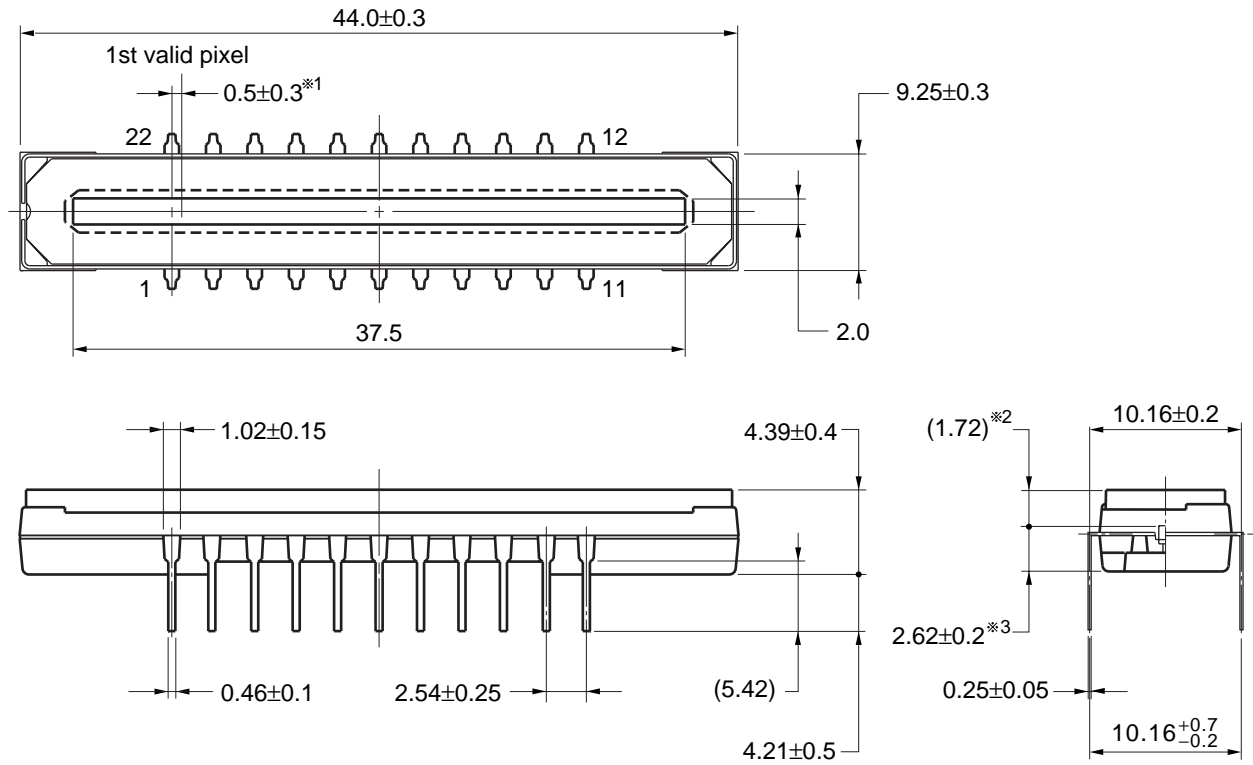

Name	Dimensions	Refractive index
Plastic cap	42.9×8.35×0.7	1.5

- ※1 1st valid pixel ←→ The center of the pin1
- ※2 The surface of the CCD chip ←→ The top of the cap
- ※3 The bottom of the package ←→ The surface of the CCD chip

22C-1CCD-PKG11-1

RECOMMENDED SOLDERING CONDITIONS

When soldering this product, it is highly recommended to observe the conditions as shown below.

If other soldering processes are used, or if the soldering is performed under different conditions, please make sure to consult with our sales offices.

Type of Through-hole Device

μPD8891CY : CCD linear image sensor 22-pin plastic DIP (10.16 mm (400))

Process	Conditions
Partial heating method	Pin temperature : 300°C or below, Heat time : 3 seconds or less (per pin)

- Cautions 1. During assembly care should be taken to prevent solder or flux from contacting the plastic cap. The optical characteristics could be degraded by such contact.**
- 2. Soldering by the solder flow method may have deleterious effects on prevention of plastic cap soiling and heat resistance. So the method cannot be guaranteed.**

NOTES ON HANDLING THE PACKAGES

① DUST AND DIRT PROTECTING

The optical characteristics of the CCD will be degraded if the cap is scratched during cleaning. Don't either touch plastic cap surface by hand or have any object come in contact with plastic cap surface. Should dirt stick to a plastic cap surface, blow it off with an air blower. For dirt stuck through electricity ionized air is recommended. And if the plastic cap surface is grease stained, clean with our recommended solvents.

○ CLEANING THE PLASTIC CAP

Care should be taken when cleaning the surface to prevent scratches.

We recommend cleaning the cap with a soft cloth moistened with one of the recommended solvents below. Excessive pressure should not be applied to the cap during cleaning. If the cap requires multiple cleanings it is recommended that a clean surface or cloth be used.

○ RECOMMENDED SOLVENTS

The following are the recommended solvents for cleaning the CCD plastic cap.

Use of solvents other than these could result in optical or physical degradation in the plastic cap. Please consult your sales office when considering an alternative solvent.

Solvents	Symbol
Ethyl Alcohol	EtOH
Methyl Alcohol	MeOH
Isopropyl Alcohol	IPA
N-methyl Pyrrolidone	NMP

② MOUNTING OF THE PACKAGE

The application of an excessive load to the package may cause the package to warp or break, or cause chips to come off internally. Particular care should be taken when mounting the package on the circuit board. Don't have any object come in contact with plastic cap. You should not reform the lead frame. We recommended to use a IC-inserter when you assemble to PCB.

Also, be care that the any of the following can cause the package to crack or dust to be generated.

1. Applying heat to the external leads for an extended period of time with soldering iron.
2. Applying repetitive bending stress to the external leads.
3. Rapid cooling or heating

③ OPERATE AND STORAGE ENVIRONMENTS

Operate in clean environments. CCD image sensors are precise optical equipment that should not be subject to mechanical shocks. Exposure to high temperatures or humidity will affect the characteristics. So avoid storage or usage in such conditions.

Keep in a case to protect from dust and dirt. Dew condensation may occur on CCD image sensors when the devices are transported from a low-temperature environment to a high-temperature environment. Avoid such rapid temperature changes.

For more details, refer to our document "Review of Quality and Reliability Handbook" (C12769E)

④ ELECTROSTATIC BREAKDOWN

CCD image sensor is protected against static electricity, but destruction due to static electricity is sometimes detected. Before handling be sure to take the following protective measures.

1. Ground the tools such as soldering iron, radio cutting pliers or of pincer.
2. Install a conductive mat or on the floor or working table to prevent the generation of static electricity.
3. Either handle bare handed or use non-chargeable gloves, clothes or material.
4. Ionized air is recommended for discharge when handling CCD image sensor.
5. For the shipment of mounted substrates, use box treated for prevention of static charges.
6. Anyone who is handling CCD image sensors, mounting them on PCBs or testing or inspecting PCBs on which CCD image sensors have been mounted must wear anti-static bands such as wrist straps and ankle straps which are grounded via a series resistance connection of about 1 MΩ.

NOTES FOR CMOS DEVICES**① PRECAUTION AGAINST ESD FOR SEMICONDUCTORS**

Note:

Strong electric field, when exposed to a MOS device, can cause destruction of the gate oxide and ultimately degrade the device operation. Steps must be taken to stop generation of static electricity as much as possible, and quickly dissipate it once, when it has occurred. Environmental control must be adequate. When it is dry, humidifier should be used. It is recommended to avoid using insulators that easily build static electricity. Semiconductor devices must be stored and transported in an anti-static container, static shielding bag or conductive material. All test and measurement tools including work bench and floor should be grounded. The operator should be grounded using wrist strap. Semiconductor devices must not be touched with bare hands. Similar precautions need to be taken for PW boards with semiconductor devices on it.

② HANDLING OF UNUSED INPUT PINS FOR CMOS

Note:

No connection for CMOS device inputs can be cause of malfunction. If no connection is provided to the input pins, it is possible that an internal input level may be generated due to noise, etc., hence causing malfunction. CMOS devices behave differently than Bipolar or NMOS devices. Input levels of CMOS devices must be fixed high or low by using a pull-up or pull-down circuitry. Each unused pin should be connected to V_{DD} or GND with a resistor, if it is considered to have a possibility of being an output pin. All handling related to the unused pins must be judged device by device and related specifications governing the devices.

③ STATUS BEFORE INITIALIZATION OF MOS DEVICES

Note:

Power-on does not necessarily define initial status of MOS device. Production process of MOS does not define the initial operation status of the device. Immediately after the power source is turned ON, the devices with reset function have not yet been initialized. Hence, power-on does not guarantee out-pin levels, I/O settings or contents of registers. Device is not initialized until the reset signal is received. Reset operation must be executed immediately after power-on for devices having reset function.

- **The information in this document is current as of March, 2003. The information is subject to change without notice. For actual design-in, refer to the latest publications of NEC Electronics data sheets or data books, etc., for the most up-to-date specifications of NEC Electronics products. Not all products and/or types are available in every country. Please check with an NEC Electronics sales representative for availability and additional information.**
- No part of this document may be copied or reproduced in any form or by any means without the prior written consent of NEC Electronics. NEC Electronics assumes no responsibility for any errors that may appear in this document.
- NEC Electronics does not assume any liability for infringement of patents, copyrights or other intellectual property rights of third parties by or arising from the use of NEC Electronics products listed in this document or any other liability arising from the use of such products. No license, express, implied or otherwise, is granted under any patents, copyrights or other intellectual property rights of NEC Electronics or others.
- Descriptions of circuits, software and other related information in this document are provided for illustrative purposes in semiconductor product operation and application examples. The incorporation of these circuits, software and information in the design of a customer's equipment shall be done under the full responsibility of the customer. NEC Electronics assumes no responsibility for any losses incurred by customers or third parties arising from the use of these circuits, software and information.
- While NEC Electronics endeavors to enhance the quality, reliability and safety of NEC Electronics products, customers agree and acknowledge that the possibility of defects thereof cannot be eliminated entirely. To minimize risks of damage to property or injury (including death) to persons arising from defects in NEC Electronics products, customers must incorporate sufficient safety measures in their design, such as redundancy, fire-containment and anti-failure features.
- NEC Electronics products are classified into the following three quality grades: "Standard", "Special" and "Specific".

The "Specific" quality grade applies only to NEC Electronics products developed based on a customer-designated "quality assurance program" for a specific application. The recommended applications of an NEC Electronics product depend on its quality grade, as indicated below. Customers must check the quality grade of each NEC Electronics product before using it in a particular application.

"Standard": Computers, office equipment, communications equipment, test and measurement equipment, audio and visual equipment, home electronic appliances, machine tools, personal electronic equipment and industrial robots.

"Special": Transportation equipment (automobiles, trains, ships, etc.), traffic control systems, anti-disaster systems, anti-crime systems, safety equipment and medical equipment (not specifically designed for life support).

"Specific": Aircraft, aerospace equipment, submersible repeaters, nuclear reactor control systems, life support systems and medical equipment for life support, etc.

The quality grade of NEC Electronics products is "Standard" unless otherwise expressly specified in NEC Electronics data sheets or data books, etc. If customers wish to use NEC Electronics products in applications not intended by NEC Electronics, they must contact an NEC Electronics sales representative in advance to determine NEC Electronics' willingness to support a given application.

(Note)

- (1) "NEC Electronics" as used in this statement means NEC Electronics Corporation and also includes its majority-owned subsidiaries.
- (2) "NEC Electronics products" means any product developed or manufactured by or for NEC Electronics (as defined above).