

# DATA SHEET

**74LVC2G86**

Dual 2-input exclusive-OR gate

Product specification

2003 Aug 25

## Dual 2-input exclusive-OR gate

## 74LVC2G86

## FEATURES

- Wide supply voltage range from 1.65 to 5.5 V
- 5 V tolerant inputs for interfacing with 5 V logic
- High noise immunity
- Complies with JEDEC standard:
  - JESD8-7 (1.65 to 1.95 V)
  - JESD8-5 (2.3 to 2.7 V)
  - JESD8B/JESD36 (2.7 to 3.6 V)
- $\pm 24$  mA output drive ( $V_{CC} = 3.0$  V)
- CMOS low power consumption
- Latch-up performance exceeds 250 mA
- Direct interface with TTL levels
- Inputs accept voltages up to 5 V
- SOT505-2 package
- ESD protection:
  - HBM EIA/JESD22-A114-A exceeds 2000 V
  - MM EIA/JESD22-A115-A exceeds 200 V.
- Specified from  $-40$  to  $+85$  °C and  $-40$  to  $+125$  °C.

## DESCRIPTION

The 74LVC2G86 is a high-performance, low-power, low-voltage, Si-gate CMOS device and superior to most advanced CMOS compatible TTL families.

Inputs can be driven from either 3.3 or 5 V devices. This feature allows the use of these devices as translators in a mixed 3.3 and 5 V environment.

This device is fully specified for partial power-down applications using  $I_{off}$ . The  $I_{off}$  circuitry disables the output, preventing the damaging backflow current through the device when it is powered down.

The 74LVC2G86 provides the dual 2-input exclusive-OR gate.

## QUICK REFERENCE DATA

GND = 0 V;  $T_{amb} = 25$  °C.

SYMBOL	PARAMETER	CONDITIONS	TYPICAL	UNIT
$t_{PHL}/t_{PLH}$	propagation delay inputs nA, nB to outputs nY	$V_{CC} = 1.8$ V; $C_L = 30$ pF; $R_L = 1$ k $\Omega$	3.8	ns
		$V_{CC} = 2.5$ V; $C_L = 30$ pF; $R_L = 500$ $\Omega$	2.5	ns
		$V_{CC} = 2.7$ V; $C_L = 50$ pF; $R_L = 500$ $\Omega$	3.0	ns
		$V_{CC} = 3.3$ V; $C_L = 50$ pF; $R_L = 500$ $\Omega$	2.3	ns
		$V_{CC} = 5.0$ V; $C_L = 50$ pF; $R_L = 500$ $\Omega$	1.9	ns
$C_I$	input capacitance		2.5	pF
$C_{PD}$	power dissipation capacitance per gate	$V_{CC} = 3.3$ V; notes 1 and 2	15.8	pF

## Notes

1.  $C_{PD}$  is used to determine the dynamic power dissipation ( $P_D$  in  $\mu$ W).

$$P_D = C_{PD} \times V_{CC}^2 \times f_i \times N + \sum(C_L \times V_{CC}^2 \times f_o) \text{ where:}$$

$f_i$  = input frequency in MHz;

$f_o$  = output frequency in MHz;

$C_L$  = output load capacitance in pF;

$V_{CC}$  = supply voltage in Volts;

$N$  = total load switching outputs;

$\sum(C_L \times V_{CC}^2 \times f_o)$  = sum of outputs.

2. The condition is  $V_i = \text{GND}$  to  $V_{CC}$ .

## Dual 2-input exclusive-OR gate

74LVC2G86

**FUNCTION TABLE**

See note 1.

INPUT		OUTPUT
nA	nB	nY
L	L	L
L	H	H
H	L	H
H	H	L

**Note**

- H = HIGH voltage level;  
L = LOW voltage level.

**ORDERING INFORMATION**

TYPE NUMBER	PACKAGE					
	TEMPERATURE RANGE	PINS	PACKAGE	MATERIAL	CODE	MARKING
74LVC2G86DP	-40 to +125 °C	8	TSSOP8	plastic	SOT505-2	V86

**PINNING**

PIN	SYMBOL	DESCRIPTION
1	1A	data input
2	1B	data input
3	2Y	data output
4	GND	ground (0 V)
5	2A	data input
6	2B	data input
7	1Y	data output
8	V <sub>CC</sub>	supply voltage

Dual 2-input exclusive-OR gate

74LVC2G86

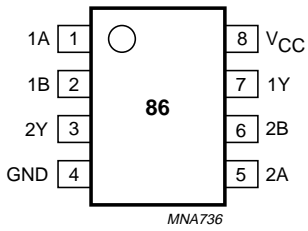

Fig.1 Pin configuration.

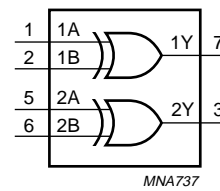

Fig.2 Logic symbol.

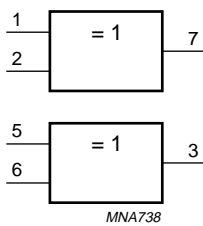

Fig.3 Logic symbol (IEEE/IEC).

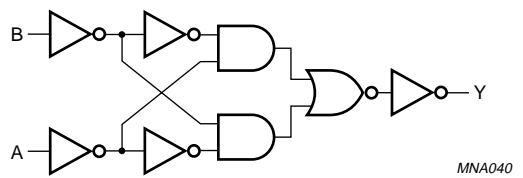

Fig.4 Logic diagram (one driver).

## Dual 2-input exclusive-OR gate

74LVC2G86

## RECOMMENDED OPERATING CONDITIONS

SYMBOL	PARAMETER	CONDITIONS	MIN.	MAX.	UNIT
$V_{CC}$	supply voltage		1.65	5.5	V
$V_I$	input voltage		0	5.5	V
$V_O$	output voltage	active mode	0	$V_{CC}$	V
		Power-down mode; $V_{CC} = 0$ V	0	5.5	V
$T_{amb}$	operating ambient temperature		-40	+125	°C
$t_r, t_f$	input rise and fall times	$V_{CC} = 1.65$ to $2.7$ V	0	20	ns/V
		$V_{CC} = 2.7$ to $5.5$ V	0	10	ns/V

## LIMITING VALUES

In accordance with the Absolute Maximum Rating System (IEC 60134); voltages are referenced to GND (ground = 0 V).

SYMBOL	PARAMETER	CONDITIONS	MIN.	MAX.	UNIT
$V_{CC}$	supply voltage		-0.5	+6.5	V
$I_{IK}$	input diode current	$V_I < 0$	-	-50	mA
$V_I$	input voltage	note 1	-0.5	+6.5	V
$I_{OK}$	output diode current	$V_O > V_{CC}$ or $V_O < 0$	-	±50	mA
$V_O$	output voltage	active mode; notes 1 and 2	-0.5	$V_{CC} + 0.5$	V
		Power-down mode; notes 1 and 2	-0.5	+6.5	V
$I_O$	output source or sink current	$V_O = 0$ to $V_{CC}$	-	±50	mA
$I_{CC}, I_{GND}$	$V_{CC}$ or GND current		-	±100	mA
$T_{stg}$	storage temperature		-65	+150	°C
$P_D$	power dissipation	$T_{amb} = -40$ to $+125$ °C	-	300	mW

## Notes

1. The input and output voltage ratings may be exceeded if the input and output current ratings are observed.
2. When  $V_{CC} = 0$  V (Power-down mode), the output voltage can be 5.5 V in normal operation.

## Dual 2-input exclusive-OR gate

## 74LVC2G86

## DC CHARACTERISTICS

At recommended operating conditions; voltages are referenced to GND (ground = 0 V).

SYMBOL	PARAMETER	TEST CONDITIONS		MIN.	TYP.	MAX.	UNIT
		OTHER	V <sub>CC</sub> (V)				
<b>T<sub>amb</sub> = -40 to +85 °C; note 1</b>							
V <sub>IH</sub>	HIGH-level input voltage		1.65 to 1.95	0.65 × V <sub>CC</sub>	–	–	V
			2.3 to 2.7	1.7	–	–	V
			2.7 to 3.6	2.0	–	–	V
			4.5 to 5.5	0.7 × V <sub>CC</sub>	–	–	V
V <sub>IL</sub>	LOW-level input voltage		1.65 to 1.95	–	–	0.35 × V <sub>CC</sub>	V
			2.3 to 2.7	–	–	0.7	V
			2.7 to 3.6	–	–	0.8	V
			4.5 to 5.5	–	–	0.3 × V <sub>CC</sub>	V
V <sub>OL</sub>	LOW-level output voltage	V <sub>I</sub> = V <sub>IH</sub> or V <sub>IL</sub> I <sub>O</sub> = 100 μA	1.65 to 5.5	–	–	0.1	V
		I <sub>O</sub> = 4 mA	1.65	–	0.07	0.45	V
		I <sub>O</sub> = 8 mA	2.3	–	0.12	0.3	V
		I <sub>O</sub> = 12 mA	2.7	–	0.17	0.4	V
		I <sub>O</sub> = 24 mA	3.0	–	0.33	0.55	V
		I <sub>O</sub> = 32 mA	4.5	–	0.39	0.55	V
V <sub>OH</sub>	HIGH-level output voltage	V <sub>I</sub> = V <sub>IH</sub> or V <sub>IL</sub> I <sub>O</sub> = -100 μA	1.65 to 5.5	V <sub>CC</sub> - 0.1	–	–	V
		I <sub>O</sub> = -4 mA	1.65	1.2	1.54	–	V
		I <sub>O</sub> = -8 mA	2.3	1.9	2.15	–	V
		I <sub>O</sub> = -12 mA	2.7	2.2	2.50	–	V
		I <sub>O</sub> = -24 mA	3.0	2.3	2.62	–	V
		I <sub>O</sub> = -32 mA	4.5	3.8	4.11	–	V
I <sub>LI</sub>	input leakage current	V <sub>I</sub> = 5.5 V or GND	5.5	–	±0.1	±5	μA
I <sub>off</sub>	power-off leakage current	V <sub>I</sub> or V <sub>O</sub> = 5.5 V	0	–	±0.1	±10	μA
I <sub>CC</sub>	quiescent supply current	V <sub>I</sub> = V <sub>CC</sub> or GND; I <sub>O</sub> = 0	5.5	–	0.1	10	μA
ΔI <sub>CC</sub>	additional quiescent supply current per pin	V <sub>I</sub> = V <sub>CC</sub> - 0.6 V; I <sub>O</sub> = 0	2.3 to 5.5	–	5	500	μA

## Dual 2-input exclusive-OR gate

## 74LVC2G86

SYMBOL	PARAMETER	TEST CONDITIONS		MIN.	TYP.	MAX.	UNIT
		OTHER	V <sub>CC</sub> (V)				
<b>T<sub>amb</sub> = -40 to +125 °C</b>							
V <sub>IH</sub>	HIGH-level input voltage		1.65 to 1.95	0.65 × V <sub>CC</sub>	–	–	V
			2.3 to 2.7	1.7	–	–	V
			2.7 to 3.6	2.0	–	–	V
			4.5 to 5.5	0.7 × V <sub>CC</sub>	–	–	V
V <sub>IL</sub>	LOW-level input voltage		1.65 to 1.95	–	–	0.35 × V <sub>CC</sub>	V
			2.3 to 2.7	–	–	0.7	V
			2.7 to 3.6	–	–	0.8	V
			4.5 to 5.5	–	–	0.3 × V <sub>CC</sub>	V
V <sub>OL</sub>	LOW-level output voltage	V <sub>I</sub> = V <sub>IH</sub> or V <sub>IL</sub> I <sub>O</sub> = 100 μA	1.65 to 5.5	–	–	0.1	V
		I <sub>O</sub> = 4 mA	1.65	–	–	0.70	V
		I <sub>O</sub> = 8 mA	2.3	–	–	0.45	V
		I <sub>O</sub> = 12 mA	2.7	–	–	0.60	V
		I <sub>O</sub> = 24 mA	3.0	–	–	0.80	V
		I <sub>O</sub> = 32 mA	4.5	–	–	0.80	V
V <sub>OH</sub>	HIGH-level output voltage	V <sub>I</sub> = V <sub>IH</sub> or V <sub>IL</sub> I <sub>O</sub> = -100 μA	1.65 to 5.5	V <sub>CC</sub> - 0.1	–	–	V
		I <sub>O</sub> = -4 mA	1.65	0.95	–	–	V
		I <sub>O</sub> = -8 mA	2.3	1.7	–	–	V
		I <sub>O</sub> = -12 mA	2.7	1.9	–	–	V
		I <sub>O</sub> = -24 mA	3.0	2.0	–	–	V
		I <sub>O</sub> = -32 mA	4.5	3.4	–	–	V
I <sub>LI</sub>	input leakage current	V <sub>I</sub> = 5.5 V or GND	5.5	–	–	±20	μA
I <sub>off</sub>	power-off leakage current	V <sub>I</sub> or V <sub>O</sub> = 5.5 V	0	–	–	±20	μA
I <sub>CC</sub>	quiescent supply current	V <sub>I</sub> = V <sub>CC</sub> or GND; I <sub>O</sub> = 0	5.5	–	–	40	μA
ΔI <sub>CC</sub>	additional quiescent supply current per pin	V <sub>I</sub> = V <sub>CC</sub> - 0.6 V; I <sub>O</sub> = 0	2.3 to 5.5	–	–	5000	μA

**Note**

1. All typical values are measured at V<sub>CC</sub> = 3.3 V and T<sub>amb</sub> = 25 °C.

Dual 2-input exclusive-OR gate

74LVC2G86

AC CHARACTERISTICS

GND = 0 V.

SYMBOL	PARAMETER	TEST CONDITIONS		MIN.	TYP.	MAX.	UNIT
		WAVEFORMS	V <sub>CC</sub> (V)				
<b>T<sub>amb</sub> = -40 to +85 °C; note 1</b>							
t <sub>PHL</sub> /t <sub>PLH</sub>	propagation delay inputs nA, nB to outputs nY	see Figs 5 and 6	1.65 to 1.95	1.4	3.8	9.9	ns
			2.3 to 2.7	0.8	2.5	5.7	ns
			2.7	0.8	3.0	5.7	ns
			3.0 to 3.6	0.8	2.3	4.7	ns
			4.5 to 5.5	0.6	1.9	3.6	ns
<b>T<sub>amb</sub> = -40 to +125 °C</b>							
t <sub>PHL</sub> /t <sub>PLH</sub>	propagation delay inputs nA, nB to outputs nY	see Figs 5 and 6	1.65 to 1.95	1.4	3.8	12.4	ns
			2.3 to 2.7	0.8	2.5	7.2	ns
			2.7	0.8	3.0	7.2	ns
			3.0 to 3.6	0.8	2.3	5.9	ns
			4.5 to 5.5	0.6	1.9	4.5	ns

Note

1. All typical values are measured at T<sub>amb</sub> = 25 °C.

AC WAVEFORMS

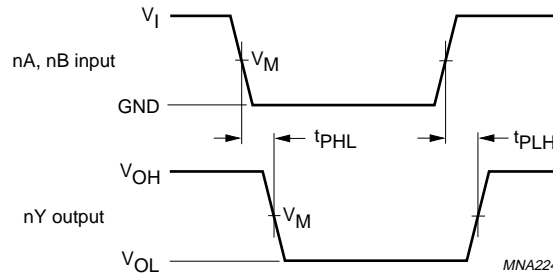

V <sub>CC</sub>	V <sub>M</sub>	INPUT	
		V <sub>I</sub>	t <sub>r</sub> = t <sub>f</sub>
1.65 to 1.95 V	0.5 × V <sub>CC</sub>	V <sub>CC</sub>	≤ 2.0 ns
2.3 to 2.7 V	0.5 × V <sub>CC</sub>	V <sub>CC</sub>	≤ 2.0 ns
2.7 V	1.5 V	2.7 V	≤ 2.5 ns
3.0 to 3.6 V	1.5 V	2.7 V	≤ 2.5 ns
4.5 to 5.5 V	0.5 × V <sub>CC</sub>	V <sub>CC</sub>	≤ 2.5 ns

V<sub>OL</sub> and V<sub>OH</sub> are typical output voltage drop that occur with the output load.

Fig.5 The inputs nA, nB to outputs nY propagation delays and the output transition times.



Dual 2-input exclusive-OR gate

74LVC2G86

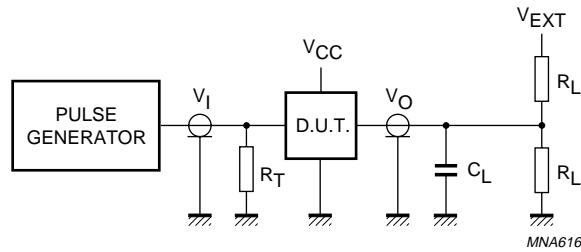

V <sub>CC</sub>	V <sub>I</sub>	C <sub>L</sub>	R <sub>L</sub>	V <sub>EXT</sub>		
				t <sub>PLH</sub> /t <sub>PHL</sub>	t <sub>PZH</sub> /t <sub>PHZ</sub>	t <sub>PZL</sub> /t <sub>PLZ</sub>
1.65 to 1.95 V	V <sub>CC</sub>	30 pF	1 kΩ	open	GND	2 × V <sub>CC</sub>
2.3 to 2.7 V	V <sub>CC</sub>	30 pF	500 Ω	open	GND	2 × V <sub>CC</sub>
2.7 V	2.7 V	50 pF	500 Ω	open	GND	6 V
3.0 to 3.6 V	2.7 V	50 pF	500 Ω	open	GND	6 V
4.5 to 5.5 V	V <sub>CC</sub>	50 pF	500 Ω	open	GND	2 × V <sub>CC</sub>

Definitions for test circuit:

R<sub>L</sub> = Load resistor.

C<sub>L</sub> = Load capacitance including jig and probe capacitance.

R<sub>T</sub> = Termination resistance should be equal to the output impedance Z<sub>o</sub> of the pulse generator.

Fig.6 Load circuitry for switching times.

Dual 2-input exclusive-OR gate

74LVC2G86

PACKAGE OUTLINE

TSSOP8: plastic thin shrink small outline package; 8 leads; body width 3 mm; lead length 0.5 mm SOT505-2

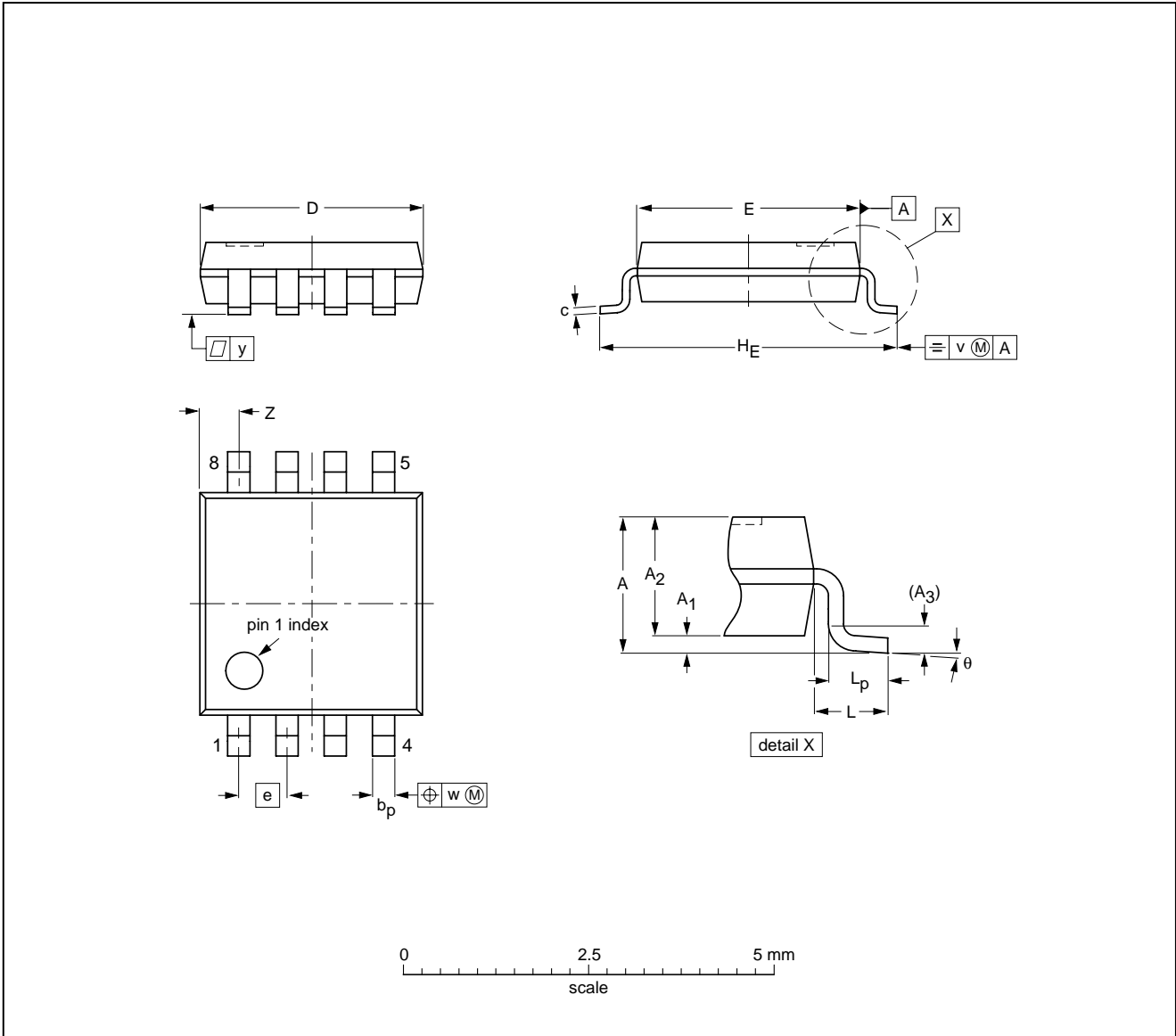

DIMENSIONS (mm are the original dimensions)

UNIT	A max.	A <sub>1</sub>	A <sub>2</sub>	A <sub>3</sub>	b <sub>p</sub>	c	D <sup>(1)</sup>	E <sup>(1)</sup>	e	H <sub>E</sub>	L	L <sub>p</sub>	v	w	y	Z <sup>(1)</sup>	θ
mm	1.1	0.15 0.00	0.95 0.75	0.25	0.38 0.22	0.18 0.08	3.1 2.9	3.1 2.9	0.65	4.1 3.9	0.5	0.47 0.33	0.2	0.13	0.1	0.70 0.35	8° 0°

Note

1. Plastic or metal protrusions of 0.15 mm maximum per side are not included.

OUTLINE VERSION	REFERENCES			EUROPEAN PROJECTION	ISSUE DATE
	IEC	JEDEC	JEITA		
SOT505-2		---			02-01-16

## Dual 2-input exclusive-OR gate

74LVC2G86

## DATA SHEET STATUS

LEVEL	DATA SHEET STATUS <sup>(1)</sup>	PRODUCT STATUS <sup>(2)(3)</sup>	DEFINITION
I	Objective data	Development	This data sheet contains data from the objective specification for product development. Philips Semiconductors reserves the right to change the specification in any manner without notice.
II	Preliminary data	Qualification	This data sheet contains data from the preliminary specification. Supplementary data will be published at a later date. Philips Semiconductors reserves the right to change the specification without notice, in order to improve the design and supply the best possible product.
III	Product data	Production	This data sheet contains data from the product specification. Philips Semiconductors reserves the right to make changes at any time in order to improve the design, manufacturing and supply. Relevant changes will be communicated via a Customer Product/Process Change Notification (CPCN).

## Notes

1. Please consult the most recently issued data sheet before initiating or completing a design.
2. The product status of the device(s) described in this data sheet may have changed since this data sheet was published. The latest information is available on the Internet at URL <http://www.semiconductors.philips.com>.
3. For data sheets describing multiple type numbers, the highest-level product status determines the data sheet status.

## DEFINITIONS

**Short-form specification** — The data in a short-form specification is extracted from a full data sheet with the same type number and title. For detailed information see the relevant data sheet or data handbook.

**Limiting values definition** — Limiting values given are in accordance with the Absolute Maximum Rating System (IEC 60134). Stress above one or more of the limiting values may cause permanent damage to the device. These are stress ratings only and operation of the device at these or at any other conditions above those given in the Characteristics sections of the specification is not implied. Exposure to limiting values for extended periods may affect device reliability.

**Application information** — Applications that are described herein for any of these products are for illustrative purposes only. Philips Semiconductors make no representation or warranty that such applications will be suitable for the specified use without further testing or modification.

## DISCLAIMERS

**Life support applications** — These products are not designed for use in life support appliances, devices, or systems where malfunction of these products can reasonably be expected to result in personal injury. Philips Semiconductors customers using or selling these products for use in such applications do so at their own risk and agree to fully indemnify Philips Semiconductors for any damages resulting from such application.

**Right to make changes** — Philips Semiconductors reserves the right to make changes in the products - including circuits, standard cells, and/or software - described or contained herein in order to improve design and/or performance. When the product is in full production (status 'Production'), relevant changes will be communicated via a Customer Product/Process Change Notification (CPCN). Philips Semiconductors assumes no responsibility or liability for the use of any of these products, conveys no licence or title under any patent, copyright, or mask work right to these products, and makes no representations or warranties that these products are free from patent, copyright, or mask work right infringement, unless otherwise specified.

# ***Philips Semiconductors – a worldwide company***

## **Contact information**

For additional information please visit <http://www.semiconductors.philips.com>. Fax: +31 40 27 24825

For sales offices addresses send e-mail to: [sales.addresses@www.semiconductors.philips.com](mailto:sales.addresses@www.semiconductors.philips.com).

© Koninklijke Philips Electronics N.V. 2003

SCA75

All rights are reserved. Reproduction in whole or in part is prohibited without the prior written consent of the copyright owner.

The information presented in this document does not form part of any quotation or contract, is believed to be accurate and reliable and may be changed without notice. No liability will be accepted by the publisher for any consequence of its use. Publication thereof does not convey nor imply any license under patent- or other industrial or intellectual property rights.

Printed in The Netherlands

R20/01/pp12

Date of release: 2003 Aug 25

Document order number: 9397 750 11851

*Let's make things better.*

**Philips  
Semiconductors**



**PHILIPS**