

PLASTIC MEDIUM- POWER SILICON TRANSISTORS

...designed for general-purpose amplifier and low speed switching applications

FEATURES:

* Collector-Emitter Sustaining Voltage-

- $V_{CEO(SUS)} = 40 \text{ V (Min) - 2N6666}$
- $= 60 \text{ V (Min) - 2N6667}$
- $= 80 \text{ V (Min) - 2N6668}$

* Collector-Emitter Saturation Voltage

- $V_{CE(sat)} = 2.0 \text{ V (Max.) @ } I_C = 3.0 \text{ A - 2N6666}$
- $= 2.0 \text{ V (Max.) @ } I_C = 5.0 \text{ A - 2N6667, 2N6668}$

* DC Current Gain $h_{FE} = 3000(\text{Typ}) @ I_C = 4.0 \text{ A}$

* Complementary to 2N6386, 2N6387, 2N6388

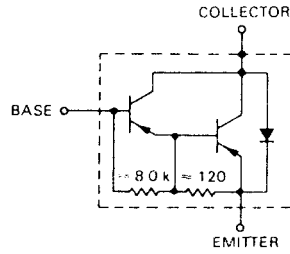

PNP
2N6666
2N6667
2N6668

8 AND 10 AMPERE
DARLINGTON
POWER TRANSISTORS
PNP SILICON
40-80 VOLTS
65 WATTS

MAXIMUM RATINGS

Characteristic	Symbol	2N6666	2N6667	2N6668	Unit
Collector-Emitter Voltage	V_{CEO}	40	60	80	V
Collector-Base Voltage	V_{CBO}	40	60	80	V
Emitter-Base Voltage	V_{EBO}	5.0			V
Collector Current-Continuous	I_C	8.0	10	10	A
-Peak	I_{CM}	15	15	15	
Base Current	I_B	0.25			A
Total Power Dissipation @ $T_C = 25^\circ\text{C}$	P_D	65			W
Derate above 25°C		0.52			W/ $^\circ\text{C}$
Operating and Storage Junction Temperature Range	T_J, T_{STG}	- 65 to +150			$^\circ\text{C}$

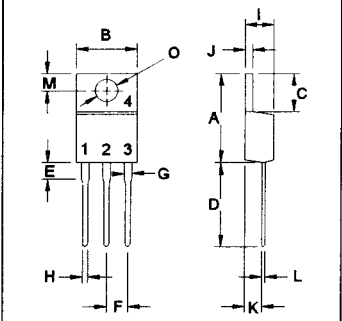
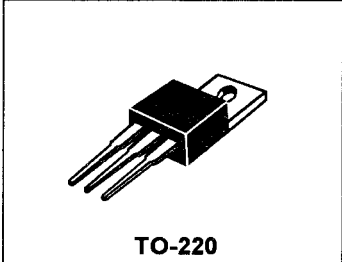

PIN 1.BASE
2.COLLECTOR
3.EMITTER
4.COLLECTOR(CASE)

THERMAL CHARACTERISTICS

Characteristic	Symbol	Max	Unit
Thermal Resistance Junction to Case	$R_{\theta jc}$	1.92	$^\circ\text{C/W}$

DIM	MILLIMETERS	
	MIN	MAX
A	14.68	15.31
B	9.78	10.42
C	5.01	6.52
D	13.06	14.62
E	3.57	4.07
F	2.42	3.66
G	1.12	1.36
H	0.72	0.96
I	4.22	4.98
J	1.14	1.38
K	2.20	2.97
L	0.33	0.55
M	2.48	2.98
O	3.70	3.90

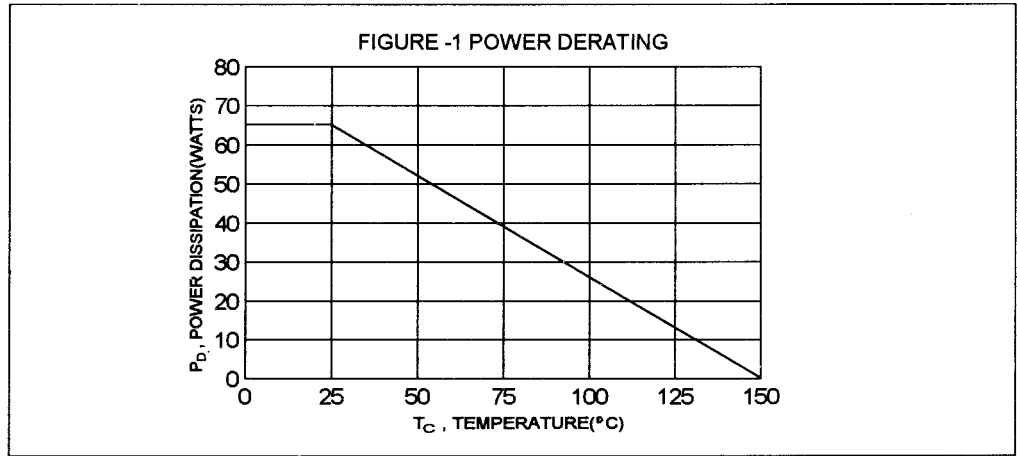

B O C A S E M I C O N D U C T O R C O R P

ELECTRICAL CHARACTERISTICS ($T_c = 25^\circ\text{C}$ unless otherwise noted)

Characteristic	Symbol	Min	Max	Unit
----------------	--------	-----	-----	------

OFF CHARACTERISTICS

Collector - Emitter Sustaining Voltage (1) ($I_c = 200 \text{ mA}$, $I_B = 0$)	2N6666 2N6667 2N6668	$V_{CEO(sus)}$	40 60 80	V
Collector Cutoff Current ($V_{CE} = 40 \text{ V}$, $I_B = 0$) ($V_{CE} = 60 \text{ V}$, $I_B = 0$) ($V_{CE} = 80 \text{ V}$, $I_B = 0$)	2N6666 2N6667 2N6668	I_{CEO}	1.0 1.0 1.0	mA
Collector Cutoff Current ($V_{CE} = 40 \text{ V}$, $V_{BE(off)} = 1.5 \text{ V}$) ($V_{CE} = 60 \text{ V}$, $V_{BE(off)} = 1.5 \text{ V}$) ($V_{CE} = 80 \text{ V}$, $V_{BE(off)} = 1.5 \text{ V}$) ($V_{CE} = 40 \text{ V}$, $V_{BE(off)} = 1.5 \text{ V}$, $T_c = 125^\circ\text{C}$) ($V_{CE} = 60 \text{ V}$, $V_{BE(off)} = 1.5 \text{ V}$, $T_c = 125^\circ\text{C}$) ($V_{CE} = 80 \text{ V}$, $V_{BE(off)} = 1.5 \text{ V}$, $T_c = 125^\circ\text{C}$)	2N6666 2N6667 2N6668 2N6666 2N6667 2N6668	I_{CEX}	0.3 0.3 0.3 3.0 3.0 3.0	mA
Emitter Cutoff Current ($V_{EB} = 5.0 \text{ V}$, $I_C = 0$)		I_{EBO}	5.0	mA

ON CHARACTERISTICS (1)

DC Current Gain ($I_c = 3.0 \text{ A}$, $V_{CE} = 3.0 \text{ V}$) ($I_c = 5.0 \text{ A}$, $V_{CE} = 3.0 \text{ V}$) ($I_c = 8.0 \text{ A}$, $V_{CE} = 3.0 \text{ V}$) ($I_c = 10 \text{ A}$, $V_{CE} = 3.0 \text{ V}$)	2N6666 2N6667, 2N6668 2N6666 2N6667, 2N6668	hFE	1000 1000 100 100	20000 20000	
Collector-Emitter Saturation Voltage ($I_c = 3.0 \text{ A}$, $I_B = 6 \text{ mA}$) ($I_c = 5.0 \text{ A}$, $I_B = 10 \text{ mA}$) ($I_c = 8.0 \text{ A}$, $I_B = 80 \text{ mA}$) ($I_c = 10 \text{ A}$, $I_B = 100 \text{ mA}$)	2N6666 2N6667, 2N6668 2N6666 2N6667, 2N6668	$V_{CE(sat)}$		2.0 2.0 3.0 3.0	V
Base-Emitter On Voltage ($I_c = 3.0 \text{ A}$, $V_{CE} = 3.0 \text{ V}$) ($I_c = 5.0 \text{ A}$, $V_{CE} = 3.0 \text{ V}$) ($I_c = 8.0 \text{ A}$, $V_{CE} = 3.0 \text{ V}$) ($I_c = 10 \text{ A}$, $V_{CE} = 3.0 \text{ V}$)	2N6666 2N6667, 2N6668 2N6666 2N6667, 2N6668	$V_{BE(on)}$		2.8 2.8 4.5 4.5	V

DYNAMIC CHARACTERISTICS

Small-Signal Current Gain ($I_c = 1.0 \text{ A}$, $V_{CE} = 5.0 \text{ V}$, $f = 1.0 \text{ KHz}$)		h_{fe}	1000		
Output Capacitance ($V_{CB} = 10 \text{ V}$, $I_E = 0$, $f = 1.0 \text{ MHz}$)		C_{ob}		200	pF

(1) Pulse Test: Pulse width = $300 \mu\text{s}$, Duty Cycle $\leq 2.0\%$

DC CURRENT GAIN

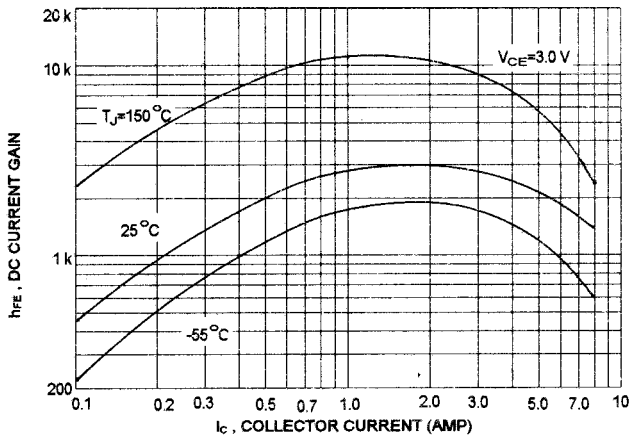

COLLECTOR SATURATION REGION

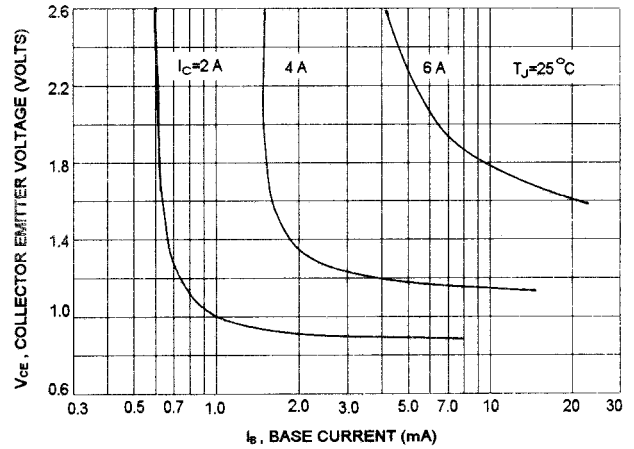

"ON" VOLTAGES

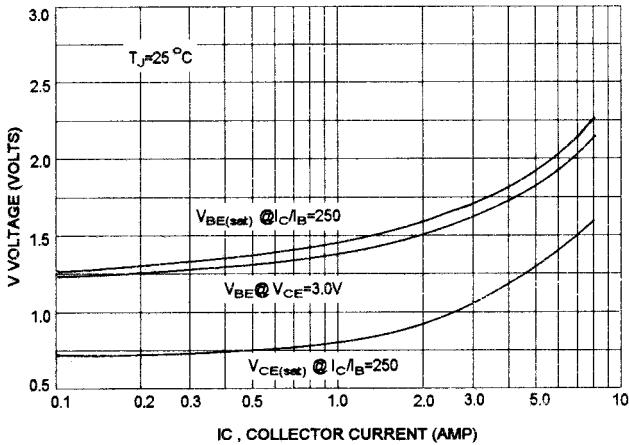

SWITCHING TIME

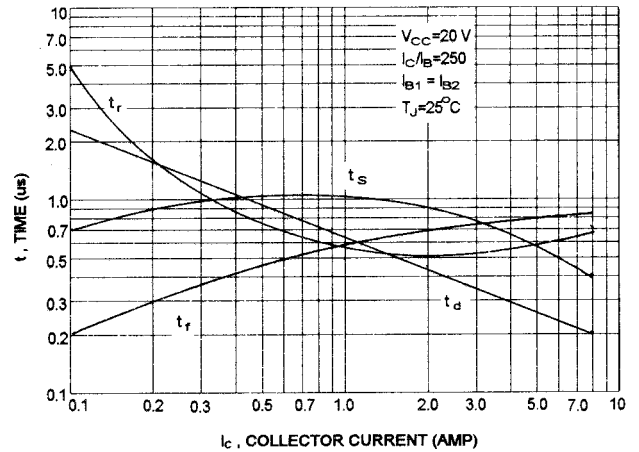

ACTIVE-REGION SAFE OPERATING AREA (SOA)

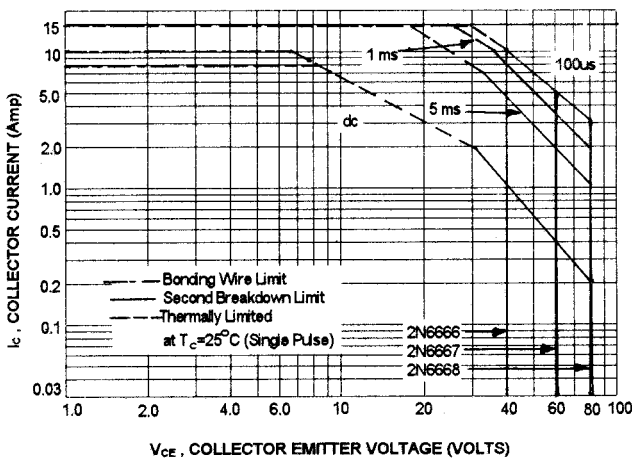

There are two limitation on the power handling ability of a transistor: average junction temperature and second breakdown safe operating area curves indicate I_C - V_{CE} limits of the transistor that must be observed for reliable operation i.e., the transistor must not be subjected to greater dissipation than curves indicate.

The data of SOA curve is base on $T_{J(PK)}=150^\circ\text{C}$; T_C is variable depending on conditions. second breakdown pulse limits are valid for duty cycles to 10% provided $T_{J(PK)} \leq 150^\circ\text{C}$. At high case temperatures, thermal limitation will reduce the power that can be handled to values less than the limitations imposed by second breakdown.