



BAT46J / BAT46W BAT46AW / BAT46CW / BAT46SW

SMALL SIGNAL SCHOTTKY DIODE

FEATURES AND BENEFITS

- VERY SMALL CONDUCTION LOSSES
- NEGLIGIBLE SWITCHING LOSSES
- LOW FORWARD VOLTAGE DROP
- SURFACE MOUNT DEVICE

DESCRIPTION

High voltage schottky rectifier suited for SLIC protection during the card insertion operation.

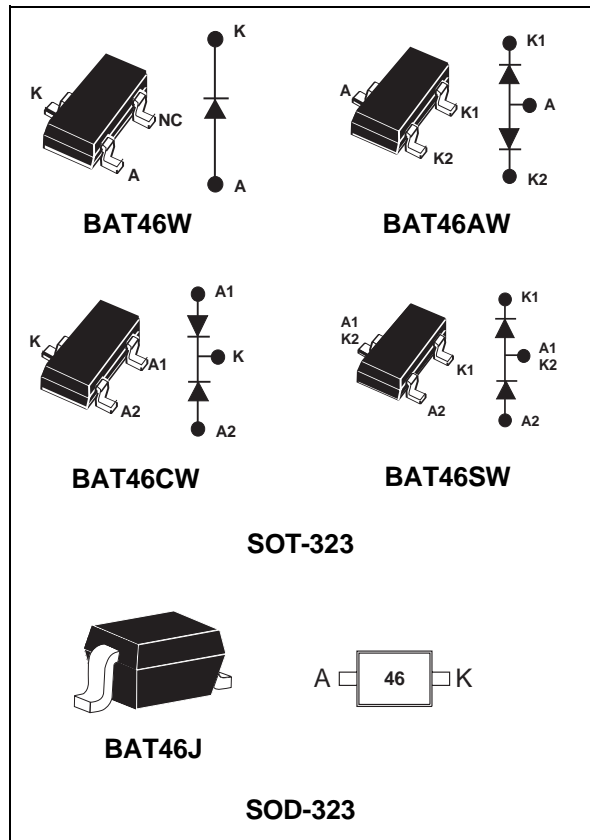

ABSOLUTE RATINGS (limiting values)

Symbol	Parameter		Value	Unit
V_{RRM}	Repetitive peak reverse voltage		100	V
I_F	Continuous forward current		150	mA
P_{tot}	Power dissipation (note 1) $T_{amb} = 25^\circ\text{C}$	SOT-323	230	mW
		SOT-323		
T_{stg}	Maximum storage temperature range		- 65 to +150	$^\circ\text{C}$
T_J	Maximum operating junction temperature *		150	$^\circ\text{C}$
T_L	Maximum temperature for soldering during 10s		260	$^\circ\text{C}$

Note 1: for double diodes, P_{tot} is the total dissipation of the both diodes.

* : $\frac{dP_{tot}}{dT_J} < \frac{1}{R_{th(j-a)}}$ thermal runaway condition for a diode on its own heatsink

BAT46J / BAT46W / BAT46AW / BAT46CW / BAT46SW**THERMAL RESISTANCE**

Symbol	Parameters		Value	Unit
R _{th(j-a)}	Junction to ambient (*)	SOD-323	550	°C/W
		SOT-323		°C/W

(*) Mounted on epoxy board, with recommended pad layout.

STATIC ELECTRICAL CHARACTERISTICS

Symbol	Test conditions		Min.	Typ.	Max.	Unit
V _{BR}	T _j = 25 °C	I _R = 100 μA	100			V
V _F *	T _j = 25 °C	I _F = 0.1 mA			0.25	V
	T _j = 25 °C	I _F = 10 mA			0.45	
	T _j = 25 °C	I _F = 250 mA			1	
I _R **	T _j = 25 °C	V _R = 1.5 V			0.5	μA
	T _j = 60 °C				5	
	T _j = 25 °C	V _R = 10 V			0.8	
	T _j = 60 °C				7.5	
	T _j = 25 °C	V _R = 50 V			2	
	T _j = 60 °C				15	
	T _j = 25 °C	V _R = 75 V			5	
	T _j = 60 °C				20	

Pulse test : * tp = 380μs δ < 2%

** tp = 5ms, δ < 2%

DYNAMIC CHARACTERISTICS

Symbol	Test conditions			Min.	Typ.	Max.	Unit
C	T _j = 25 °C	V _R = 0 V	F = 1MHz		10		pF
	T _j = 25 °C	V _R = 1 V			6		

Fig. 1: Forward current versus forward voltage at different temperatures (typical values).

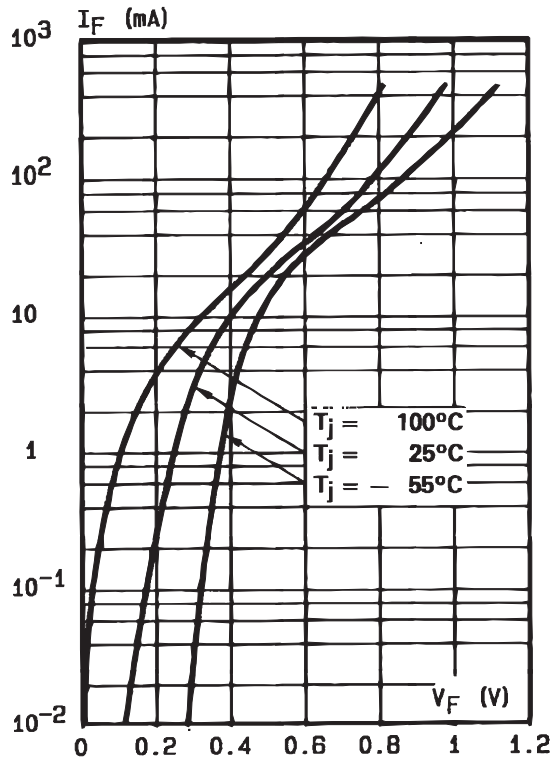

Fig. 2: Forward current versus forward voltage (typical values).

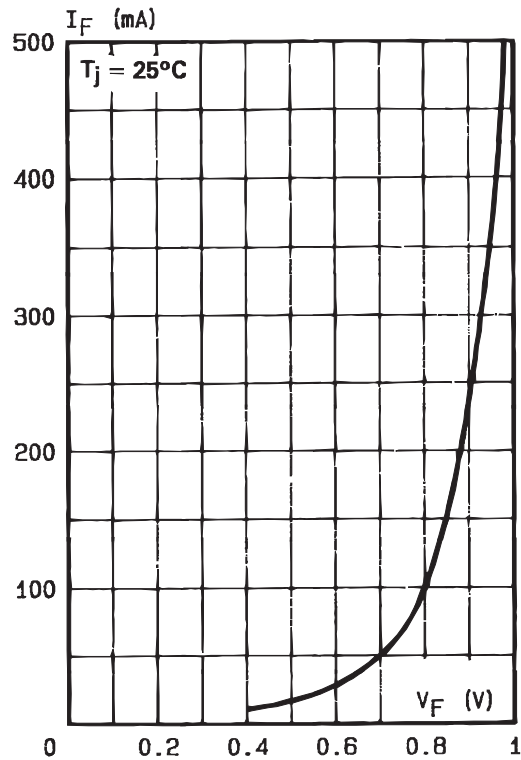

Fig. 3: Reverse current versus junction temperature (typical values).

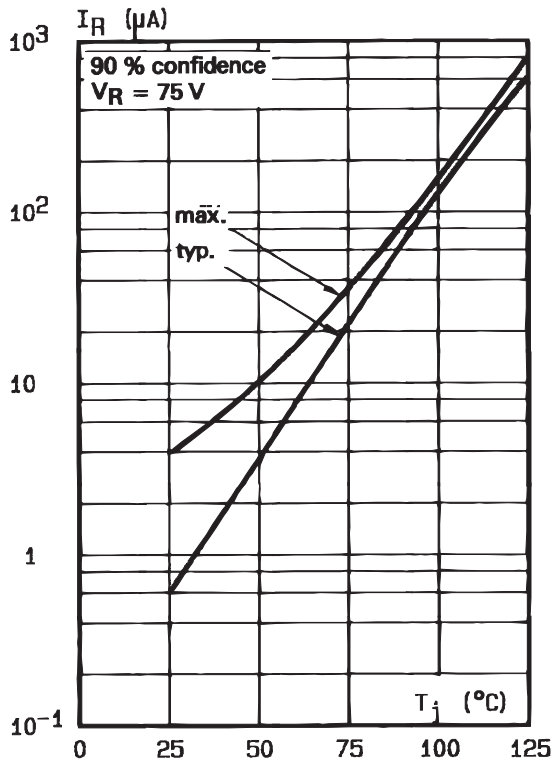
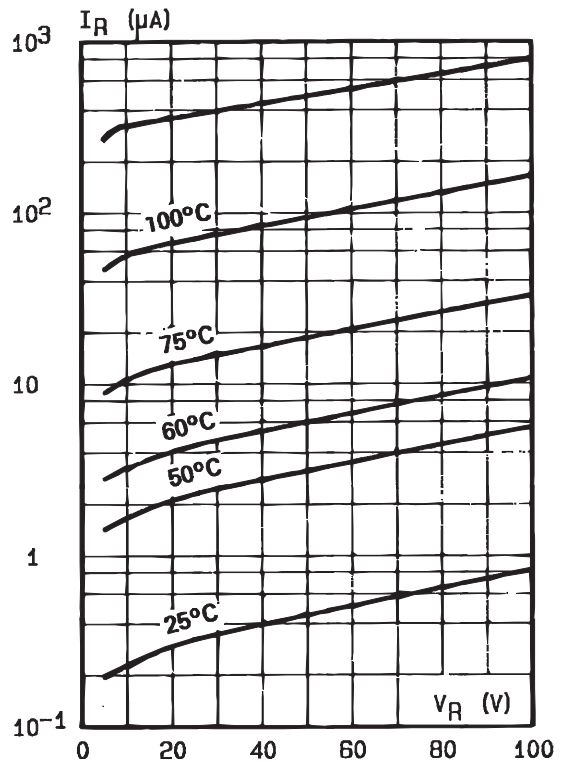
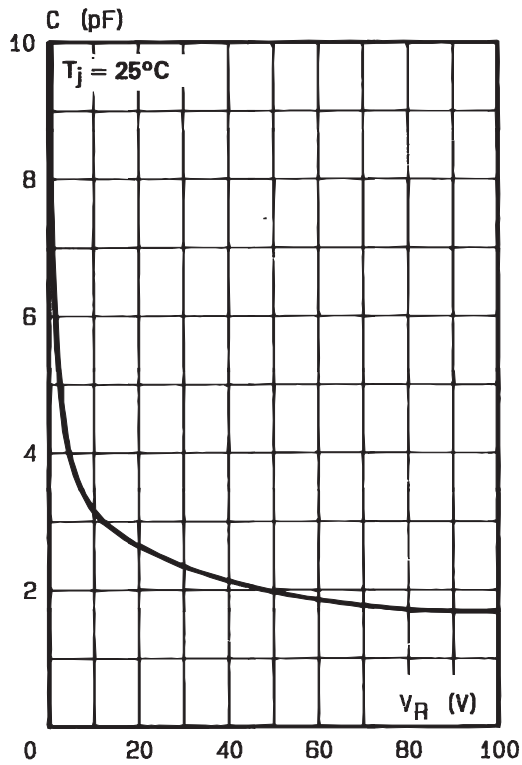

Fig. 4: Reverse current versus continuous reverse voltage (typical values).



BAT46J / BAT46W / BAT46AW / BAT46CW / BAT46SW

Fig. 5: Capacitance C versus reverse applied voltage V_R (typical values).



PACKAGE MECHANICAL DATA
SOT-323

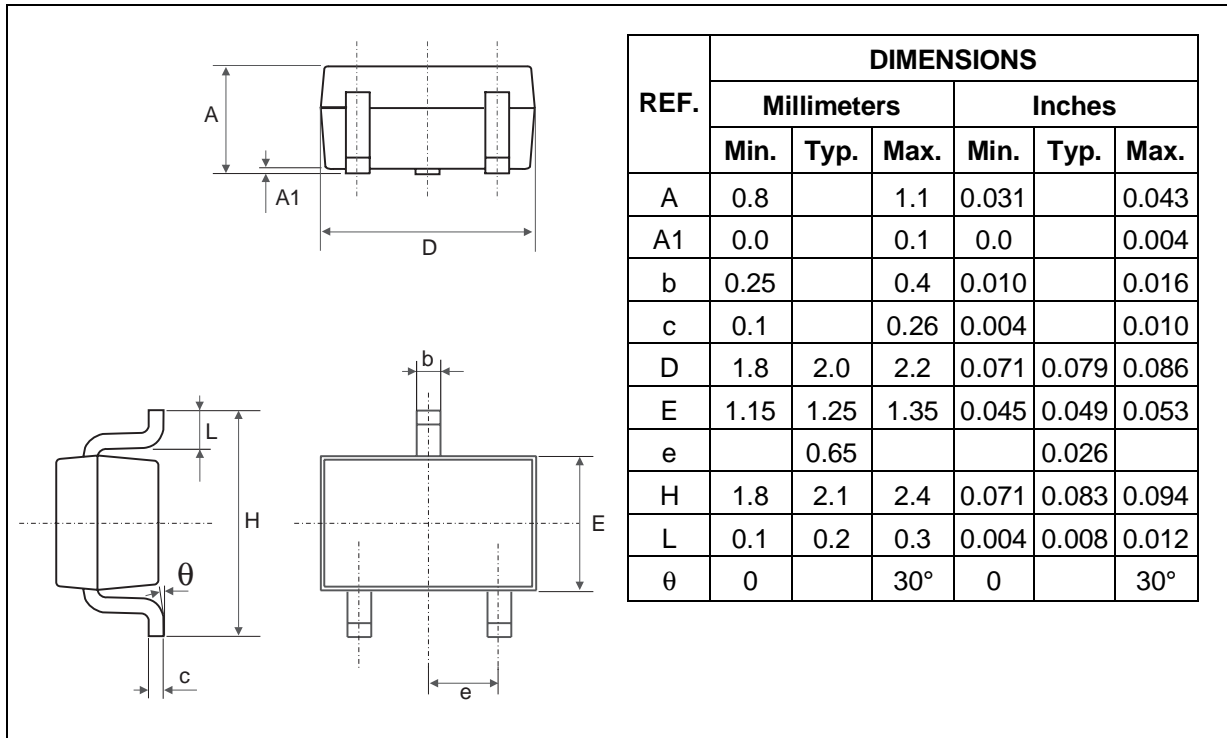

PACKAGE MECHANICAL DATA
SOD-323

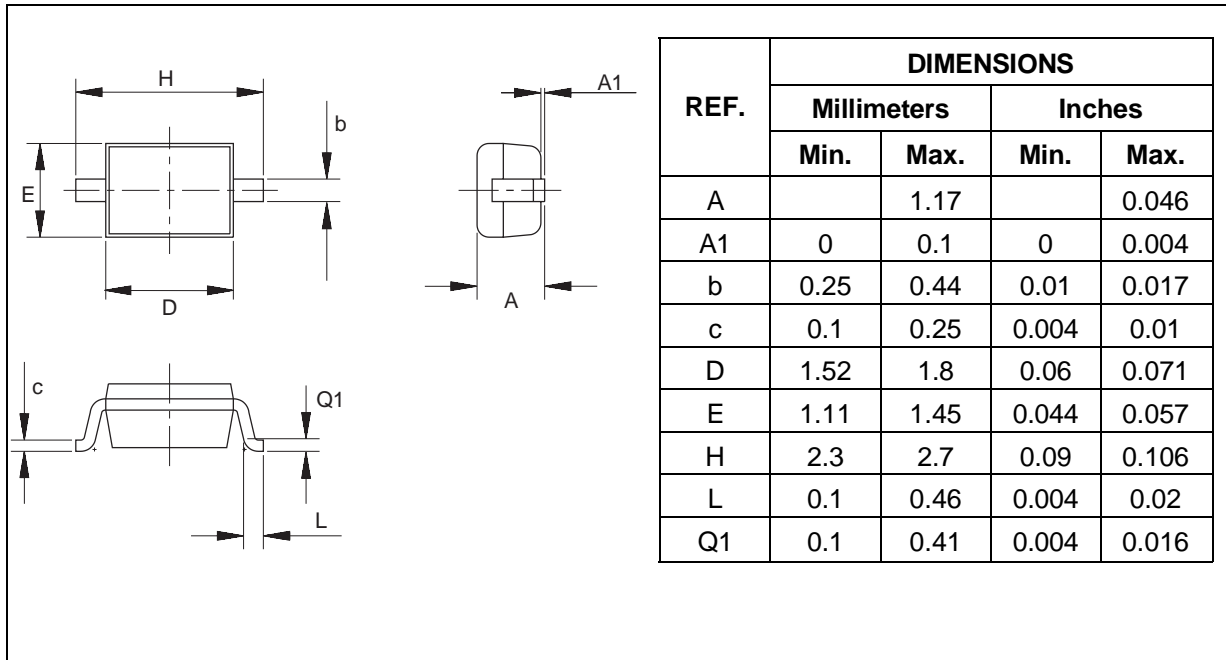

Ordering type	Marking	Package	Weight	Base qty	Delivery mode
BAT46W	D46	SOT-323	0.006g	3000	Tape & reel
BAT46AW	DB6	SOT-323	0.006g	3000	Tape & reel
BAT46CW	TBD	SOT-323	0.006g	3000	Tape & reel
BAT46SW	TBD	SOT-323	0.006g	3000	Tape & reel
BAT46J	46	SOD-323	0.005g	3000	Tape & reel

■ Epoxy meets UL94,V0

Information furnished is believed to be accurate and reliable. However, STMicroelectronics assumes no responsibility for the consequences of use of such information nor for any infringement of patents or other rights of third parties which may result from its use. No license is granted by implication or otherwise under any patent or patent rights of STMicroelectronics. Specifications mentioned in this publication are subject to change without notice. This publication supersedes and replaces all information previously supplied. STMicroelectronics products are not authorized for use as critical components in life support devices or systems without express written approval of STMicroelectronics.

The ST logo is a registered trademark of STMicroelectronics

© 1999 STMicroelectronics - Printed in Italy - All rights reserved.

STMicroelectronics GROUP OF COMPANIES

Australia - Brazil - China - Finland - France - Germany - Hong Kong - India - Italy - Japan - Malaysia
Malta - Morocco - Singapore - Spain - Sweden - Switzerland - United Kingdom - U.S.A.

<http://www.st.com>