

## Micropower, 150mA / 3.3V Low Dropout CMOS Regulator

### Features

- Regulated 3.3V output
- Delivers up to 150mA output current
- Very low dropout (150mV at 150mA)
- Low quiescent operating current (100 $\mu$ A)
- "Zero" disable mode current consumption
- Thermal overload protection
- Foldback overload current protection
- -40°C to +85°C temperature operation
- Thermally enhanced MSOP-8 and SOT23 package options

### Applications

- CompactFlash memory cards
- Battery-Powered Devices
- PC Cards
- Peripheral Adapter Cards
- Wireless Handsets
- PDAs/Handheld PCs

### Product Description

The CMPWR163-33 is a very low dropout regulator that delivers up to 150mA of load current at a fixed 3.3V output (when powered from 5V). The dropout characteristics of the device also allows it to be powered from a 3.3V supply, in which case, the device simply appears as a low resistance switch (1.0 ohm).

A dedicated control input (EN, active high) provides power-up sequencing flexibility. When this input is taken low, the regulator is disabled. In this state, the supply current will drop to near zero. An internal discharge MOSFET (300 $\Omega$ ) impedance will force the output to ground whenever the device has been shutdown.

The CMPWR163-33 is fully protected, offering both overload current limiting and high temperature thermal shutdown.

Two package options are available—a 5-pin SOT23 and a space saving 8-pin MSOP package, thermally enhanced through use of an integral leadframe to ensure maximum junction to ambient power dissipation.

### Typical Application Circuit

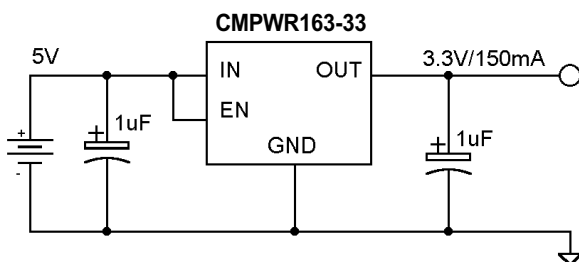

### Simplified Electrical Schematic

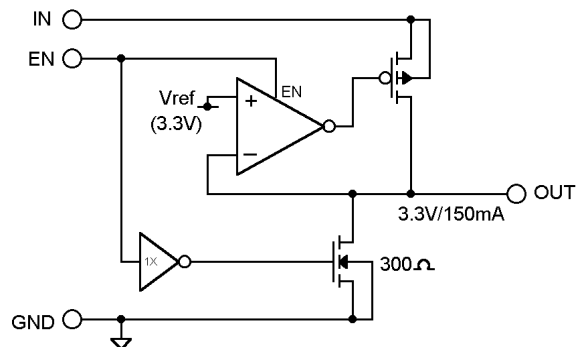

**PACKAGE / PINOUT DIAGRAMS**

Note: MSOP and SOT23 package sizes may differ.  
These drawings are not to scale.

**PIN DESCRIPTIONS**

PIN(S)		NAME	DESCRIPTION
MSOP	SOT23		
1	3	EN	A logic input control to enable the regulator output. When EN is asserted (logic high), it allows output regulation to commence. When EN is deasserted (logic low), the regulator pass transistor is forced into a high impedance mode, and an internal discharge resistance (300Ω) is applied to the output.
2	1	IN	The input power supply (5.0V, 3.3V nominal) for the regulator. If this input is within a few inches of the main supply filter, a capacitor may not be necessary. Otherwise an input filter capacitor of approximately 1uF will ensure adequate filtering.
3	5	OUT	The regulator voltage output (3.3V) used to power the load. A nominal output capacitor of 1uF is sufficient to minimize any transient disturbances under normal operating conditions. Additional output capacitance can be used to further improve transient load response.
5,6,7,8	2	GND	The negative reference for all voltages.
4	4	NC	This pin has no connection to the internal device. To provide additional thermal performance, this pin can be connected directly to the PC board GND plane.

**Ordering Information**
**PART NUMBERING INFORMATION**

Pins	Package	Ordering Part Number <sup>1</sup>	Part Marking
8	Power MSOP-8	CMPWR163MA	163M
5	SOT23	Note 2	Note 2

Note 1: Parts are shipped in Tape & Reel form unless otherwise specified.

Note 2: Consult California Micro Devices for part number and part marking information.



Specifications

ABSOLUTE MAXIMUM RATINGS		
PARAMETER	RATING	UNITS
ESD Protection (HBM)	±2000	V
Pin Voltages		
IN (pin 2)	[GND - 0.6] to [+6.0]	V
EN (pin 1)	[GND - 0.6] to [V <sub>IN</sub> + 0.6]	V
OUT (pin 3)	[GND - 0.6] to [V <sub>IN</sub> + 0.6]	V
Storage Temperature Range	-40 to +150	°C
Operating Temperature Range		
Ambient	-40 to +85	°C
Junction	-40 to +125	°C
Power Dissipation (Notes 1,2)	Internally Limited	W

Note 1: The CMPWR163-33 packaged in the MSOP-8 package contains a thermal overload circuit that automatically disables the device, thereby preventing excessive junction temperatures. The MSOP package housing the device is thermally enhanced through the use of a fused integral leadframe; when mounted on a typical multi-layer board with moderate heat-spreading copper area (2 square inches), it will allow up to 0.45W to be dissipated safely. (Please consult CAMD Technical Support for thermal evaluation assistance.)

Note 2: Consult CAMD Technical Support for power dissipation information regarding the CMPWR163-33 packaged in the SOT23 package.

STANDARD OPERATING CONDITIONS		
PARAMETER	RATING	UNITS
V <sub>IN</sub>	2.7 to 5.5	V
Ambient Operating Temperature Range	-40 to +85	°C
Load Current	0 to +150	mA
C <sub>EXT</sub>	1 ±20%	µF



## Specifications (continued)

ELECTRICAL OPERATING CHARACTERISTICS						
SYMBOL	PARAMETER	CONDITIONS	MIN	TYP	MAX	UNITS
$V_{OUT}$	Regulator Output Voltage	$0\text{mA} < I_{LOAD} < 150\text{mA}$ ; $V_{IN}=5.0\text{V}$	3.10	3.30	3.50	V
$R_{DROPOUT}$	Dropout Resistance	$0\text{mA} < I_{LOAD} < 150\text{mA}$ ; $V_{IN}=3.3\text{V}$		1	1.3	$\Omega$
$V_{R\,LOAD}$	Load Regulation	$10\text{mA} < I_{LOAD} < 150\text{mA}$ ; $V_{IN}=5.0\text{V}$		5		mV
$V_{R\,LINE}$	Line Regulation	$I_{LOAD} = 5\text{mA}$ ; $4.5\text{V} \leq V_{IN} \leq 5.5\text{V}$		20		mV
$I_{LIM}$	Overload Current Limit			400		mA
$I_{SC}$	Short Circuit Current Limit	$V_{OUT} < 1\text{V}$		200		mA
$R_{DISCH}$	Discharge Resistance	EN tied to ground; $V_{IN}=3.0\text{V}$		300		$\Omega$
$I_{GND}$	Ground Current	with EN tied to $V_{IN}$ ; $I_{LOAD} = 0\text{mA}$ : with EN tied to $V_{IN}$ ; $I_{LOAD} = 150\text{mA}$ : with EN tied to GND (Disable Mode):		80 100 0.1	200 250 10	$\mu\text{A}$ $\mu\text{A}$ $\mu\text{A}$
$V_{IH}$	Enable High Threshold	Regulator becomes enabled		0.8	1.2	V
$V_{IL}$	Enable Low Threshold	Regulator enters shutdown	0.4	0.7		V
$T_{DISABLE}$	Shutdown Temperature			150		$^{\circ}\text{C}$
$T_{HYST}$	Thermal Hysteresis			20		$^{\circ}\text{C}$



### Performance Information

Typical DC Characteristics (nominal conditions unless specified otherwise)

Ground Current vs. Input

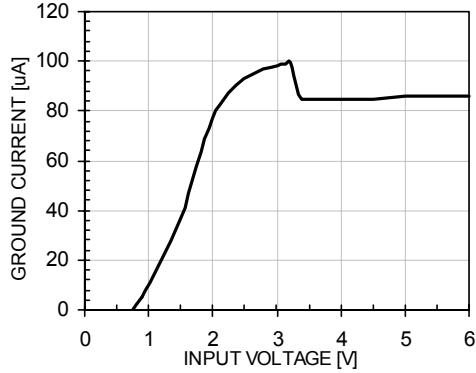

Ground Current vs. Load

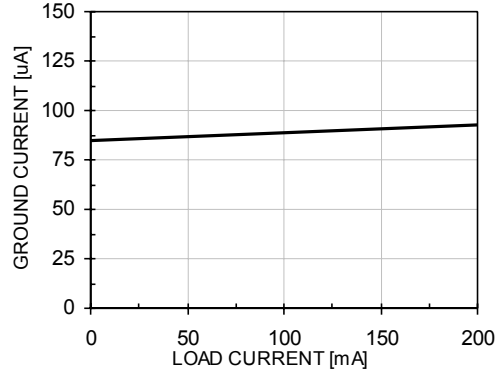

Load Regulation ( $V_{IN} = 5V$ )

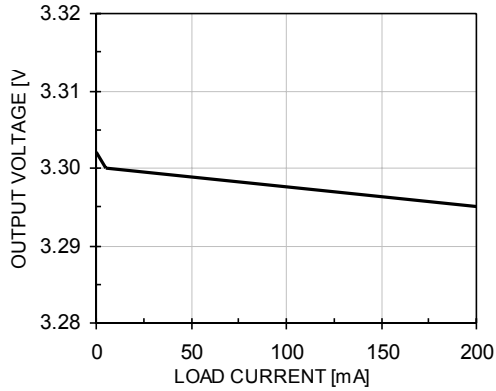

Dropout Voltage vs. Load Current ( $V_{IN} = 2.7V$ )

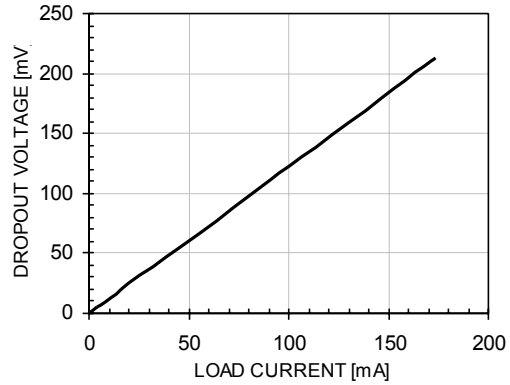

Line Regulation (5mA and 150mA load)

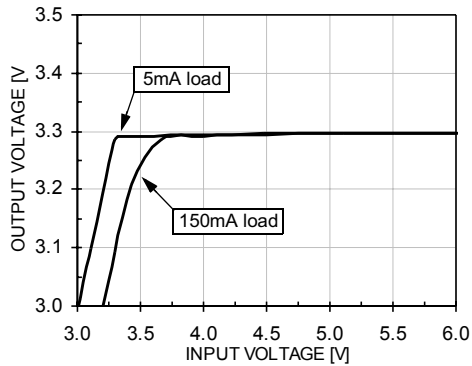

Foldback Current Limiting

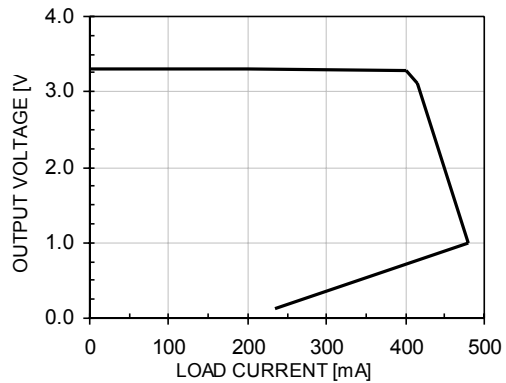

**Performance Information (continued)**

Typical Transient Characteristics (nominal conditions unless specified otherwise)

Load Transient (1% to 100%) Step Response

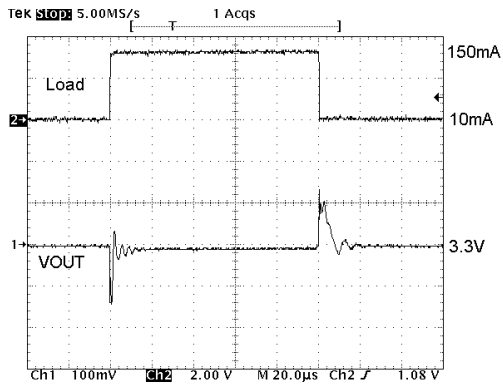

Line Transient (1Vpp) Step Response

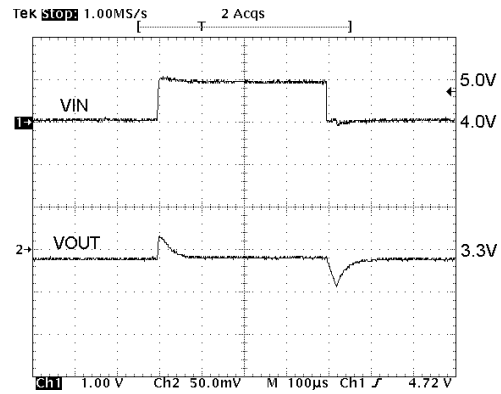

Enable Response (No Load)

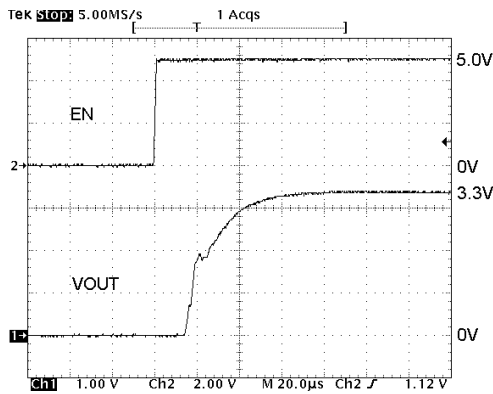

Disable Response (No Load)

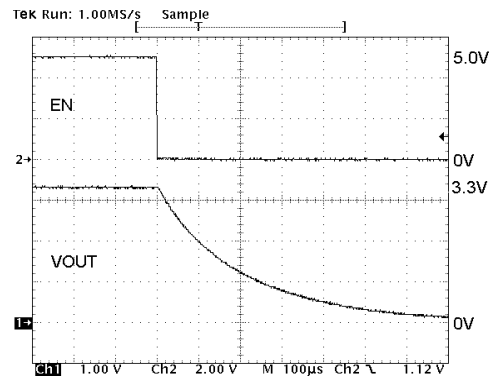

**Performance Information (continued)**

**Typical Thermal Characteristics**

The overall junction to ambient thermal resistance ( $\theta_{JA}$ ) for device power dissipation ( $P_D$ ) consists primarily of two paths in series. The first path is the junction to the case ( $\theta_{JC}$ ) which is defined by the package style, and the second path is case to ambient ( $\theta_{CA}$ ) thermal resistance which is dependent on board layout. The final operating junction temperature for any set of conditions can be estimated by the following thermal equation:

$$T_{JUNC} = T_{AMB} + P_D * (\theta_{JC}) + P_D * (\theta_{CA})$$

$$= T_{AMB} + P_D * (\theta_{JA})$$

The CMPWR163-33MA with the Power MSOP packaging option uses a thermally enhanced MSOP-8 package where all the GND pins (5 through 8) are integral to the leadframe. When this package is mounted on a double sided printed circuit board with two square inches of copper allocated for “heat spreading”, the resulting  $\theta_{JA}$  is 70°C/W.

Based on a maximum power dissipation of 0.255W (Load x Vin-Vout = 150mA x 1.7V) with an ambient of 70°C the resulting junction temperature will be:

$$T_{JUNC} = T_{AMB} + P_D * (\theta_{JA})$$

$$= 70^\circ\text{C} + 0.255\text{W} * (70^\circ\text{C}/\text{W})$$

$$= 70^\circ\text{C} + 18^\circ\text{C} = 88^\circ\text{C}$$

Thermal characteristics were measured using a double sided board with two square inches of copper area connected to the GND pins for “heat spreading”.

Measurements showing performance up to a junction temperature of 125°C are presented in Figure 1. They were performed under light load conditions (5mA); this allows the ambient temperature to be representative of the internal junction temperature.

**Note:** The use of multi-layer board construction with separate ground and power planes will further enhance the overall thermal performance. In the event of no copper area being dedicated for heat spreading, a multi-layer board construction using only the minimum size pad layout will typically provide the CMPWR163-33MA (in an MSOP package) with an overall  $\theta_{JA}$  of 90°C/W, which allows up to 600mW to be dissipated safely.

Please consult CAMD Technical Support for assistance with thermal analysis of the CMPWR163-33 in either an MSOP or SOT23 package with respect to a specific application.

Output Voltage Change vs. Temperature (5mA load)

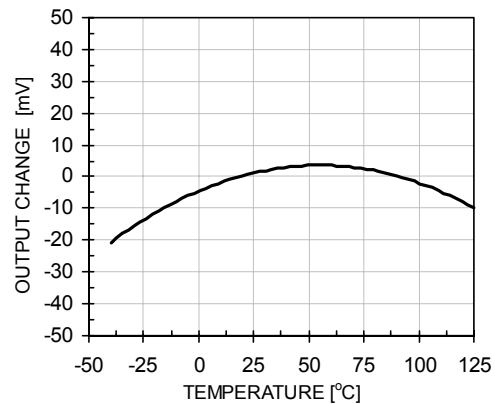

Ground Current vs. Temperature

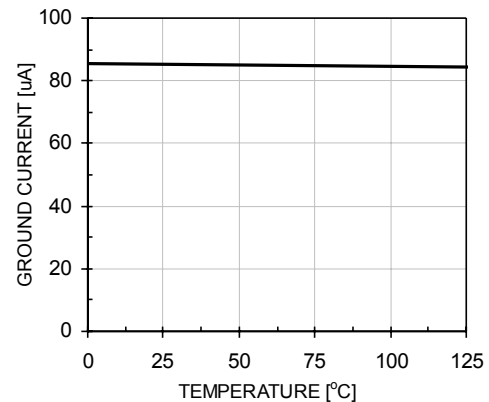

**Figure 1. CMPWR163-33 Performance vs. Temperature**



### Mechanical Details

CMPWR163-33 devices are packaged in either 8-pin MSOP packages or 5-pin SOT23 packages.

#### MSOP-8 Mechanical Specifications:

Dimensions for CMPWR163-33 devices packaged in 8-pin MSOP packages are presented below.

For complete information on the MSOP-8 package, see the California Micro Devices MSOP Package Information document.

PACKAGE DIMENSIONS				
Package	MSOP			
Pins	8			
Dimensions	Millimeters		Inches	
	Min	Max	Min	Max
A	0.87	1.17	0.034	0.046
A1	0.05	0.25	0.002	0.010
B	0.30 (typ)		0.012 (typ)	
C	0.18		0.007	
D	2.90	3.10	0.114	0.122
E	2.90	3.10	0.114	0.122
e	0.65 BSC		0.025 BSC	
H	4.78	4.98	0.188	0.196
L	0.52	0.54	0.017	0.025
# per tube	80 pieces*			
# per tape and reel	4000 pieces			
Controlling dimension: inches				

\* This is an approximate amount which may vary.

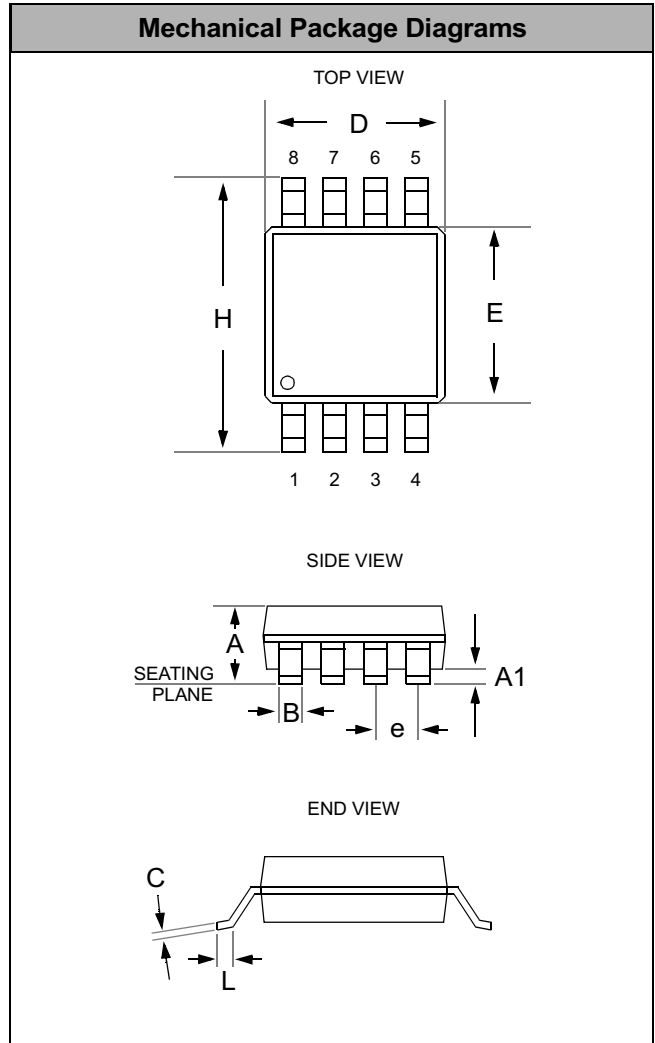

Package Dimensions for MSOP-8





### Mechanical Details (continued)

#### SOT23 Mechanical Specifications

Dimensions for CMPWR163-33 devices packaged in 5-pin SOT23 packages are presented below.

For complete information on the SOT23 package, see the California Micro Devices SOT23 Package Information document.

PACKAGE DIMENSIONS				
Package	SOT23 (JEDEC name is MO-178)			
Pins	5			
Dimensions	Millimeters		Inches	
	Min	Max	Min	Max
A	--	1.45	--	0.057
A1	0.00	0.15	0.000	0.006
b	0.30	0.50	0.012	0.020
c	0.08	0.22	0.003	0.009
D	2.75	3.05	0.108	0.120
E	2.60	3.00	0.102	0.118
E1	1.45	1.75	0.057	0.069
e	0.95 BSC		0.0374 BSC	
e1	1.90 BSC		0.0748 BSC	
L	0.60 REF		0.0236 REF	
# per tape and reel	3000 pieces			
Controlling dimension: inches				

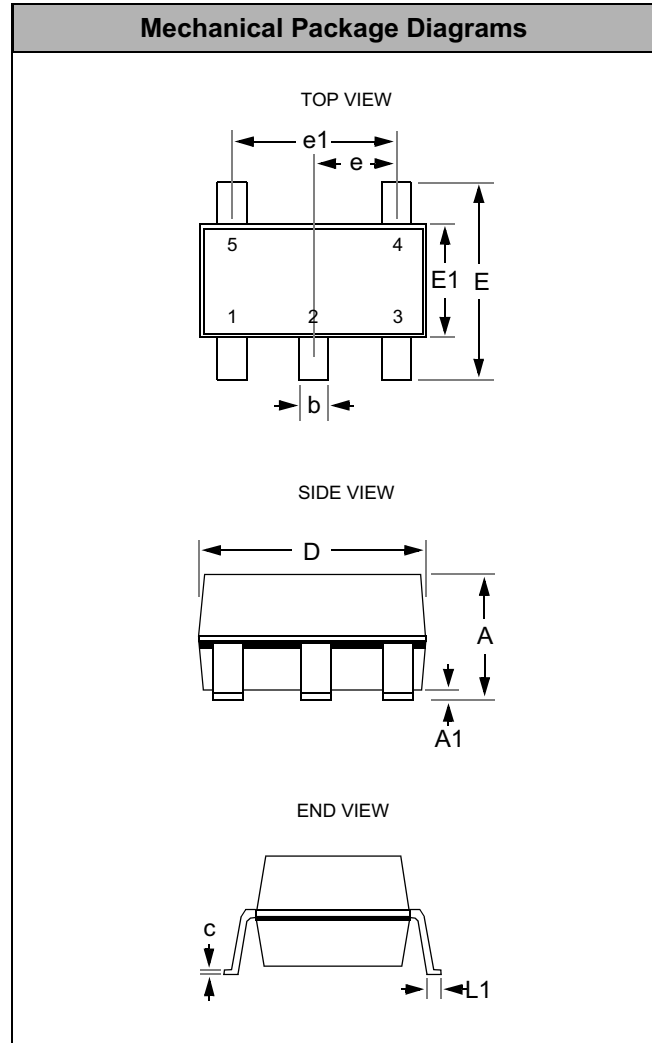

Package Dimensions for SOT23-5.