

Advance Information

SWITCHMODE™ Power Rectifier

The SWITCHMODE power rectifier employs the use of the Schottky Barrier principle with a Platinum barrier metal. This state-of-the-art device has the following features:

- Very Low Forward Voltage Drop (Max 0.58 V @ 100°C)
- Guardring for Stress Protection and High dv/dt Capability (> 10 V/ns)
- Guaranteed Reverse Avalanche
- 150°C Operating Junction Temperature
- Specially Designed for SWITCHMODE Power Supplies with Operating Frequency up to 300 kHz

Mechanical Characteristics

- Case: Epoxy, Molded
- Weight: 4.3 grams (approximately)
- Finish: All External Surfaces Corrosion Resistant and Terminal Leads are Readily Solderable
- Lead Temperature for Soldering Purposes: 260°C Max. for 10 Seconds
- Shipped 30 Units Per Plastic Tube
- Marking: B5025L

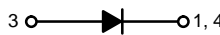

MBR5025L

Motorola Preferred Device

**SCHOTTKY BARRIER
RECTIFIER
LOW v_F
40 AMPERES
45 VOLTS**

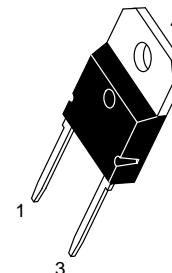

CASE 340E-02

MAXIMUM RATINGS

Rating	Symbol	Max	Unit
Peak Repetitive Reverse Voltage Working Peak Reverse Voltage DC Blocking Voltage	V_{RRM} V_{RWM} V_R	25	Volt
Average Rectified Forward Current $T_C = 125^\circ\text{C}$	$I_{F(AV)}$	50	Amp
Peak Repetitive Forward Current, Per Diode (Rated V_R , Square Wave, 20 kHz) @ $T_C = 90^\circ\text{C}$	I_{FRM}	150	Amp
Non Repetitive Peak Surge Current (Surge applied at rated load conditions halfwave, single phase, 60 Hz)	I_{FSM}	300	Amp
Peak Repetitive Reverse Current (2.0 μs , 1.0 kHz)	I_{RRM}	2.0	Amp
Operating Junction Temperature	T_J	-65 to +150	°C
Storage Temperature	T_{stg}	-65 to +175	°C
Peak Surge Junction Temperature (Forward Current Applied)	$T_{J(pk)}$	175	°C
Voltage Rate of Change	dv/dt	10,000	V/ μs

THERMAL CHARACTERISTICS

Thermal Resistance — Junction to Case	$R_{\theta JC}$	0.75	°C/W
---------------------------------------	-----------------	------	------

SWITCHMODE is a trademark of Motorola, Inc.

This document contains information on a new product. Specifications and information herein are subject to change without notice.

Preferred devices are Motorola recommended choices for future use and best overall value.

Rev 2

MBR5025L

ELECTRICAL CHARACTERISTICS

Rating	Symbol	Max	Unit
Instantaneous Forward Voltage (1) @ $I_F = 50$ Amps, $T_C = 25^\circ\text{C}$ @ $I_F = 50$ Amps, $T_C = 125^\circ\text{C}$ @ $I_F = 30$ Amps, $T_C = 25^\circ\text{C}$	V_F	0.62 0.58 0.54	Volts
Instantaneous Reverse Current (1) @ Rated DC Voltage, $T_C = 25^\circ\text{C}$ @ Rated DC Voltage, $T_C = 100^\circ\text{C}$	I_R	0.5 60	mA

(1) Pulse Test: Pulse Width = 300 μs , Duty Cycle $\leq 2.0\%$

TYPICAL ELECTRICAL CHARACTERISTICS

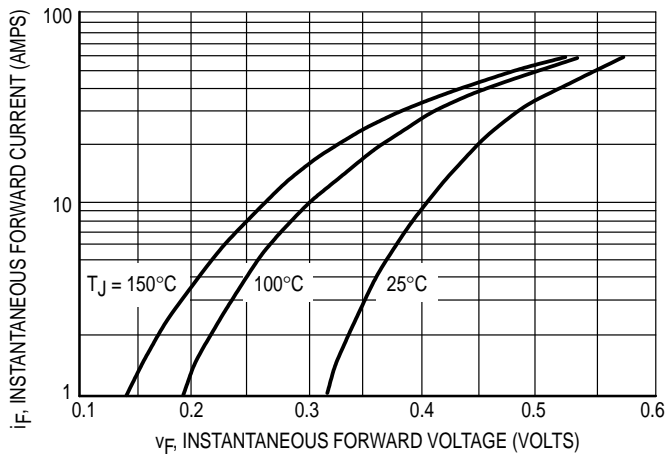

Figure 1. Typical Forward Voltage

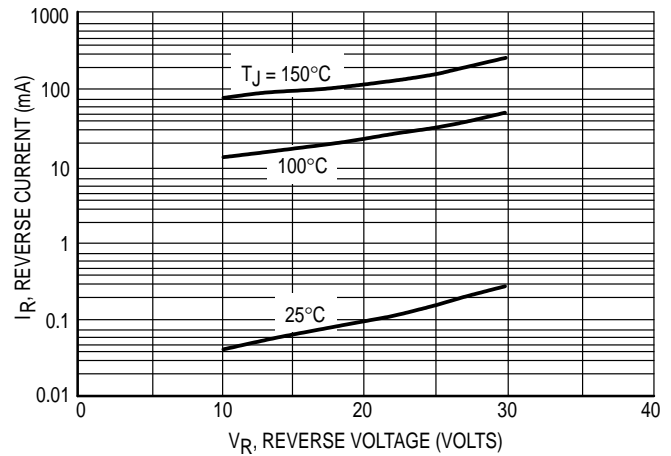

Figure 2. Typical Reverse Current

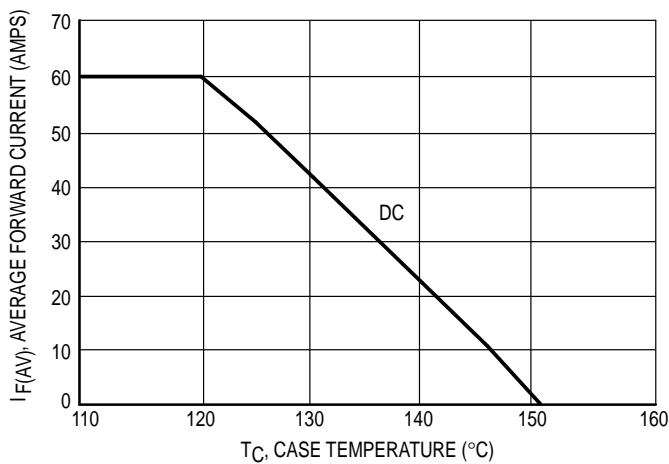

Figure 3. Current Derating, Case

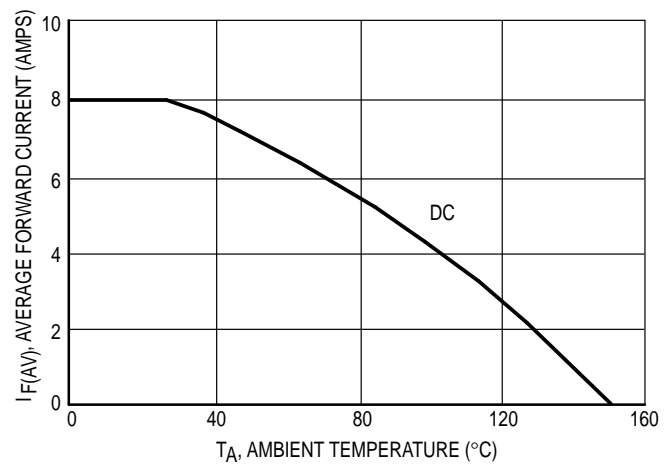
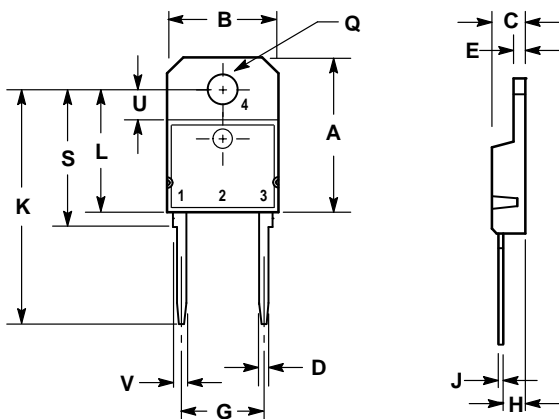

Figure 4. Current Derating, Ambient

PACKAGE DIMENSIONS



- NOTES:
 1. DIMENSIONING AND TOLERANCING PER ANSI Y14.5M, 1982
 2. CONTROLLING DIMENSION: MILLIMETER.

DIM	MILLIMETERS		INCHES	
	MIN	MAX	MIN	MAX
A	—	20.35	—	0.801
B	14.70	15.20	0.579	0.598
C	4.70	4.90	0.185	0.193
D	1.10	1.30	0.043	0.051
E	1.17	1.37	0.046	0.054
G	10.80	11.10	0.425	0.437
H	2.00	3.00	0.079	0.118
J	0.50	0.78	0.020	0.031
K	31.00 REF	—	1.220 REF	—
L	—	16.20	—	0.638
Q	4.00	4.10	0.158	0.161
S	17.80	18.20	0.701	0.717
U	4.00 REF	—	0.157 REF	—
V	1.75 REF	—	0.069	—

STYLE 1:
 PIN 1. CATHODE
 3. ANODE
 4. CATHODE

CASE 340E-02
 ISSUE A

Motorola reserves the right to make changes without further notice to any products herein. Motorola makes no warranty, representation or guarantee regarding the suitability of its products for any particular purpose, nor does Motorola assume any liability arising out of the application or use of any product or circuit, and specifically disclaims any and all liability, including without limitation consequential or incidental damages. "Typical" parameters which may be provided in Motorola data sheets and/or specifications can and do vary in different applications and actual performance may vary over time. All operating parameters, including "Typicals" must be validated for each customer application by customer's technical experts. Motorola does not convey any license under its patent rights nor the rights of others. Motorola products are not designed, intended, or authorized for use as components in systems intended for surgical implant into the body, or other applications intended to support or sustain life, or for any other application in which the failure of the Motorola product could create a situation where personal injury or death may occur. Should Buyer purchase or use Motorola products for any such unintended or unauthorized application, Buyer shall indemnify and hold Motorola and its officers, employees, subsidiaries, affiliates, and distributors harmless against all claims, costs, damages, and expenses, and reasonable attorney fees arising out of, directly or indirectly, any claim of personal injury or death associated with such unintended or unauthorized use, even if such claim alleges that Motorola was negligent regarding the design or manufacture of the part. Motorola and  are registered trademarks of Motorola, Inc. Motorola, Inc. is an Equal Opportunity/Affirmative Action Employer.

Mfax is a trademark of Motorola, Inc.

How to reach us:

USA/EUROPE/Locations Not Listed: Motorola Literature Distribution;
P.O. Box 5405, Denver, Colorado 80217. 1-303-675-2140 or 1-800-441-2447

JAPAN: Nippon Motorola Ltd.: SPD, Strategic Planning Office, 4-32-1,
Nishi-Gotanda, Shinagawa-ku, Tokyo 141, Japan. 81-3-5487-8488

Customer Focus Center: 1-800-521-6274

Mfax™: RMFAX0@email.sps.mot.com – TOUCHTONE 1-602-244-6609
Motorola Fax Back System – US & Canada ONLY 1-800-774-1848
– http://sps.motorola.com/mfax/

ASIA/PACIFIC: Motorola Semiconductors H.K. Ltd.; 8B Tai Ping Industrial Park,
51 Ting Kok Road, Tai Po, N.T., Hong Kong. 852-26629298

HOME PAGE: <http://motorola.com/sps/>

**MOTOROLA**