

MM74HCT08 Quad 2-Input AND Gate

General Description

The MM74HCT08 is a logic function fabricated by using advanced silicon-gate CMOS technology which provides the inherent benefits of CMOS—low quiescent power and wide power supply range. This device is input and output characteristic and pinout compatible with standard 74LS logic families. All inputs are protected from static discharge damage by internal diodes to V_{CC} and ground.

MM74HCT devices are intended to interface between TTL and NMOS components and standard CMOS devices.

These parts are also plug-in replacements for LS-TTL devices and can be used to reduce power consumption in existing designs.

Features

- TTL, LS pin-out and threshold compatible
- Fast switching: t_{PLH} , $t_{PHL} = 12$ ns (typ)
- Low power: 10 μ W at DC
- High fan-out, 10 LS-TTL loads

Ordering Code:

Order Number	Package Number	Package Description
MM74HCT08M	M14A	14-Lead Small Outline Integrated Circuit (SOIC), JEDEC MS-120, 0.150" Narrow
MM74HCT08SJ	M14D	14-Lead Small Outline Package (SOP), EIAJ TYPE II, 5.3mm Wide
MM74HCT08MTC	MTC14	14-Lead Thin Shrink Small Outline Package (TSSOP), JEDEC MO-153, 4.4mm Wide
MM74HCT08N	N14A	14-Lead Plastic Dual-In-Line Package (PDIP), JEDEC MS-001, 0.300" Wide

Devices also available in Tape and Reel. Specify by appending the suffix letter "X" to the ordering code.

Connection Diagram

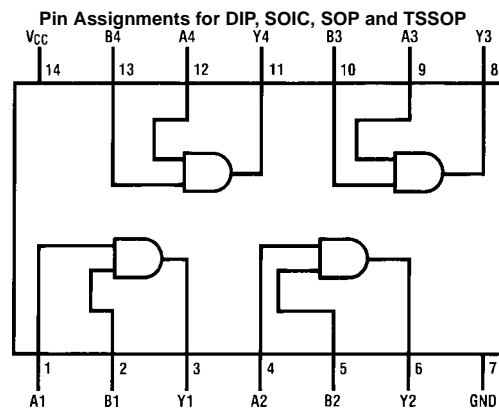

Logic Diagram

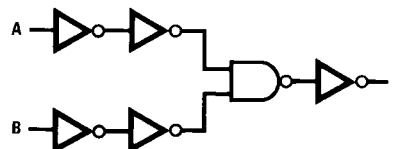

Absolute Maximum Ratings (Note 1)

(Note 2)

Supply Voltage (V_{CC})	-0.5 to +7.0V
DC Input Voltage (V_{IN})	-1.5 to $V_{CC} + 1.5V$
DC Output Voltage (V_{OUT})	-0.5 to $V_{CC} + 0.5V$
Clamp Diode Current (I_{IK}, I_{OK})	± 20 mA
DC Output Current, per pin (I_{OUT})	± 25 mA
DC V_{CC} or GND Current, per pin (I_{CC})	± 50 mA
Storage Temperature Range (T_{STG})	-65°C to +150°C
Power Dissipation (P_D)	
(Note 3)	600 mW
S.O. Package only	500 mW
Lead Temperature (T_L)	
(Soldering 10 seconds)	260°C

Recommended Operating Conditions

	Min	Max	Units
Supply Voltage (V_{CC})	4.5	5.5	V
DC Input or Output Voltage (V_{IN}, V_{OUT})	0	V_{CC}	V
Operating Temperature Range (T_A)	-40	+85	°C
Input Rise or Fall Times (t_r, t_f)		500	ns

Note 1: Absolute Maximum Ratings are those values beyond which damage to the device may occur.**Note 2:** Unless otherwise specified all voltages are referenced to ground.**Note 3:** Power Dissipation temperature derating — plastic "N" package — 12 mW/°C from 65°C to 85°C.**DC Electrical Characteristics** $V_{CC} = 5V \pm 10\%$ (unless otherwise specified)

Symbol	Parameter	Conditions	$T_A = 25^\circ C$		$T_A = -40$ to $85^\circ C$	$T_A = -55$ to $125^\circ C$	Units
			Typ	Guaranteed Limits			
V_{IH}	Minimum HIGH Level Input Voltage			2.0	2.0	2.0	V
V_{IL}	Maximum LOW Level Input Voltage			0.8	0.8	0.8	V
V_{OH}	Minimum HIGH Level Output Voltage	$V_{IN} = V_{IH}$ or V_{IL}	V_{CC}	$V_{CC} - 0.1$	$V_{CC} - 0.1$	$V_{CC} - 0.1$	V
		$ I_{OUT} = 20 \mu A$	4.2	3.98	3.84	3.7	V
		$ I_{OUT} = 4.0$ mA, $V_{CC} = 4.5V$	5.2	4.98	4.84	4.7	V
V_{OL}	Maximum LOW Level Voltage	$V_{IN} = V_{IH}$	0	0.1	0.1	0.1	V
		$ I_{OUT} = 20 \mu A$	0.2	0.26	0.33	0.4	V
		$ I_{OUT} = 4.0$ mA, $V_{CC} = 4.5V$	0.2	0.26	0.33	0.4	V
I_{IN}	Maximum Input Current	$V_{IN} = V_{CC}$ or GND, V_{IH} or V_{IL}		± 0.1	± 1.0	± 1.0	μA
		$V_{IN} = V_{CC}$ or GND		2.0	20	40	μA
I_{CC}	Maximum Quiescent Supply Current	$I_{OUT} = 0 \mu A$		1.2	1.4	1.5	mA
		$V_{IN} = 2.4V$ or $0.5V$ (Note 4)					

Note 4: This is measured per input with all other inputs held at V_{CC} or ground.

AC Electrical Characteristics							
$V_{CC} = 5.0V$, $t_r = t_f = 6$ ns, $C_L = 15$ pF, $T_A = 25^\circ C$							
Symbol	Parameter	Conditions	Typ	Guaranteed Limit	Units		
t_{PLH} , t_{PHL}	Maximum Propagation Delay		9	15	ns		
AC Electrical Characteristics							
$V_{CC} = 5.0V \pm 10\%$, $t_r = t_f = 6$ ns, $C_L = 50$ pF							
Symbol	Parameter	Conditions	$T_A = 25^\circ C$		$T_A = -40$ to $85^\circ C$	$T_A = -55$ to $125^\circ C$	Units
			Typ	Guaranteed Limits			
t_{PLH} , t_{PHL}	Maximum Propagation Delay		11	18	23	27	ns
t_{rHL} , t_{fLH}	Maximum Output Rise & Fall Time		7	15	19	22	ns
C_{PD}	Power Dissipation Capacitance	(Note 5)	38				pF
C_{IN}	Input Capacitance		5	10	10	10	pF
<p>Note 5: C_{PD} determines the no load dynamic power consumption. $P_D = C_{PD} V_{CC}^2 f + I_{CC} V_{CC}$ and the no load dynamic current consumption, $I_S = C_{PD} V_{CC} f + I_{CC}$.</p>							

Physical Dimensions inches (millimeters) unless otherwise noted

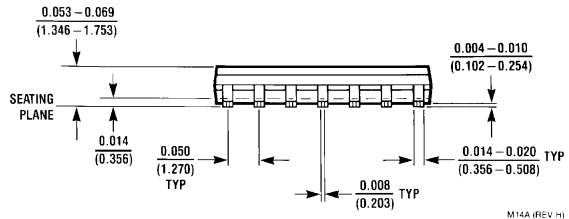
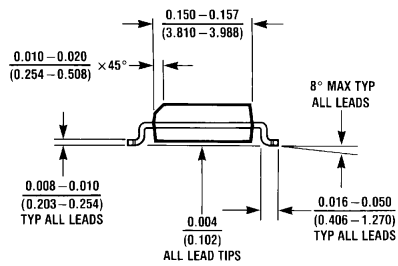
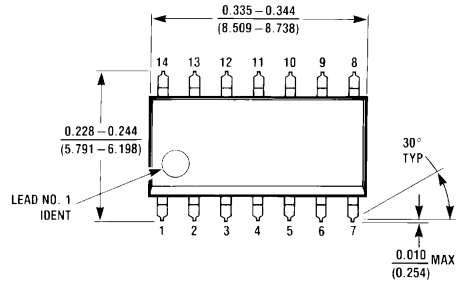

**14-Lead Small Outline Integrated Circuit (SOIC), JEDEC MS-120, 0.150" Narrow
Package Number M14A**

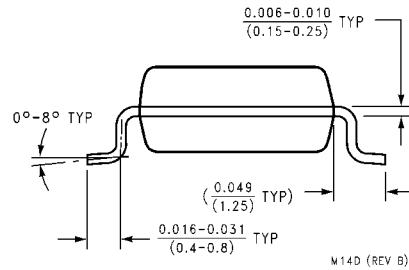
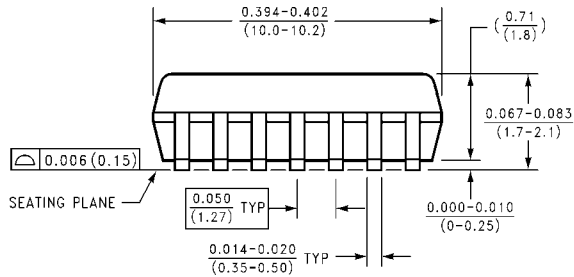
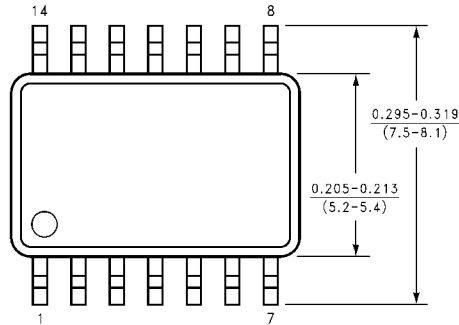

**14-Lead Small Outline Package (SOP), EIAJ TYPE II, 5.3mm Wide
Package Number M14D**

Physical Dimensions inches (millimeters) unless otherwise noted (Continued)

14LD, TSSOP, JEDEC MO-153, 4.4MM WIDE

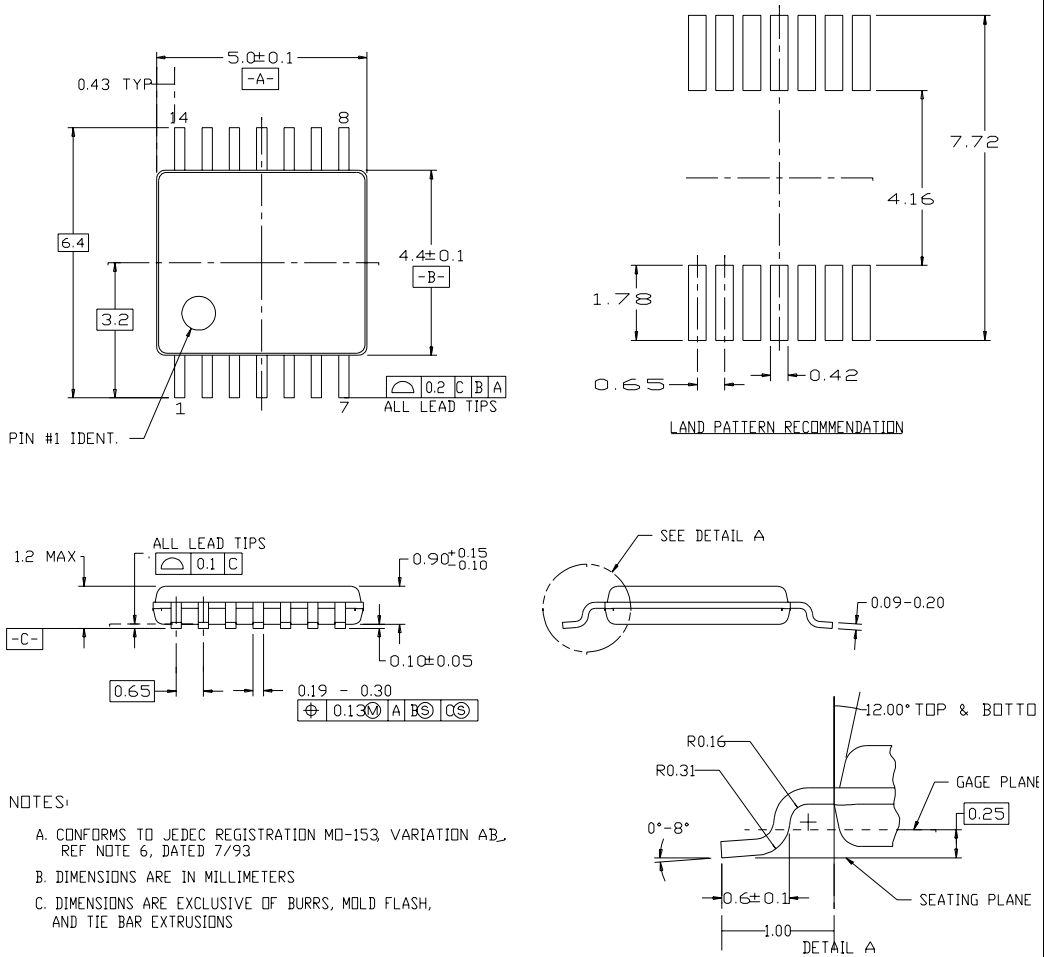

NOTES:

- A. CONFORMS TO JEDEC REGISTRATION MO-153, VARIATION AB, REF NOTE 6, DATED 7/93
- B. DIMENSIONS ARE IN MILLIMETERS
- C. DIMENSIONS ARE EXCLUSIVE OF BURRS, MOLD FLASH, AND TIE BAR EXTRUSIONS

**14-Lead Thin Shrink Small Outline Package (TSSOP), JEDEC MO-153, 4.4mm Wide
Package Number MTC14**

Physical Dimensions inches (millimeters) unless otherwise noted (Continued)

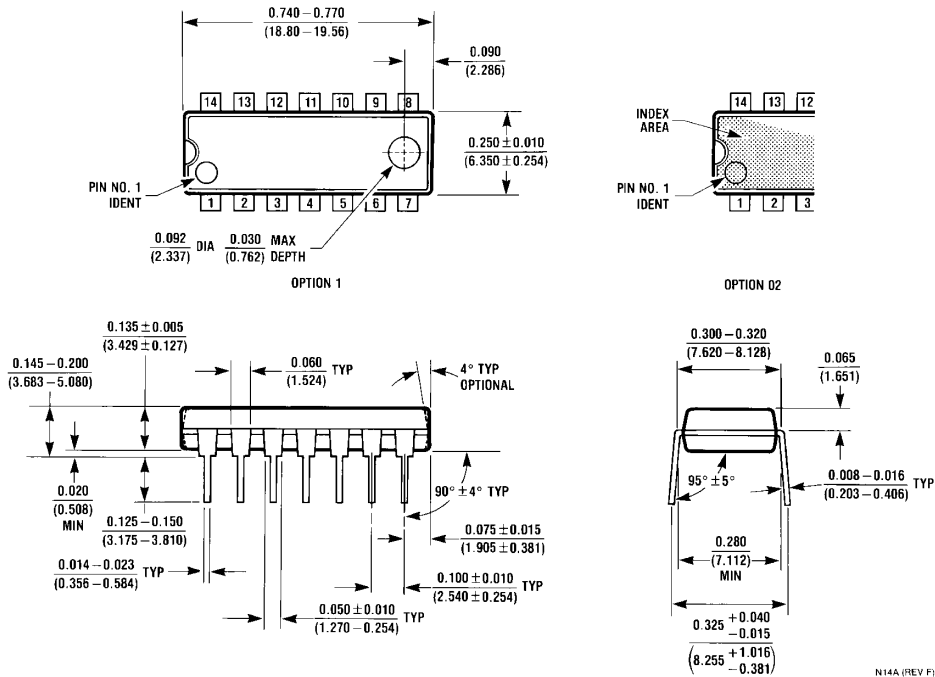

LIFE SUPPORT POLICY

FAIRCHILD'S PRODUCTS ARE NOT AUTHORIZED FOR USE AS CRITICAL COMPONENTS IN LIFE SUPPORT DEVICES OR SYSTEMS WITHOUT THE EXPRESS WRITTEN APPROVAL OF THE PRESIDENT OF FAIRCHILD SEMICONDUCTOR CORPORATION. As used herein:

1. Life support devices or systems are devices or systems which, (a) are intended for surgical implant into the body, or (b) support or sustain life, and (c) whose failure to perform when properly used in accordance with instructions for use provided in the labeling, can be reasonably expected to result in a significant injury to the user.
2. A critical component in any component of a life support device or system whose failure to perform can be reasonably expected to cause the failure of the life support device or system, or to affect its safety or effectiveness.

www.fairchildsemi.com