



N-Channel Depletion-Mode Vertical DMOS FETs

Ordering Information

BV _{DSX} / BV _{DGX}	R _{DS(ON)} (max)	I _{DSS} (min)	Order Number / Package		
			TO-92	TO-243AA*	Die
300V	12Ω	200mA	DN2530N3	DN2530N8	DN2530ND

* Same as SOT-89. Product shipped on 2000 piece carrier tape reels.

Features

- High input impedance
- Low input capacitance
- Fast switching speeds
- Low on resistance
- Free from secondary breakdown
- Low input and output leakage

Applications

- Normally-on switches
- Solid state relays
- Converters
- Linear amplifiers
- Constant current sources
- Power supply circuits
- Telecom

Absolute Maximum Ratings

Drain-to-Source Voltage	BV _{DSX}
Drain-to-Gate Voltage	BV _{DGX}
Gate-to-Source Voltage	± 20V
Operating and Storage Temperature	-55°C to +150°C
Soldering Temperature*	300°C

* Distance of 1.6 mm from case for 10 seconds.

Advanced DMOS Technology

These depletion-mode (normally-on) transistors utilize an advanced vertical DMOS structure and Supertex's well-proven silicon-gate manufacturing process. This combination produces devices with the power handling capabilities of bipolar transistors and with the high input impedance and positive temperature coefficient inherent in MOS devices. Characteristic of all MOS structures, these devices are free from thermal runaway and thermally-induced secondary breakdown.

Supertex's vertical DMOS FETs are ideally suited to a wide range of switching and amplifying applications where high breakdown voltage, high input impedance, low input capacitance, and fast switching speeds are desired.

Package Options

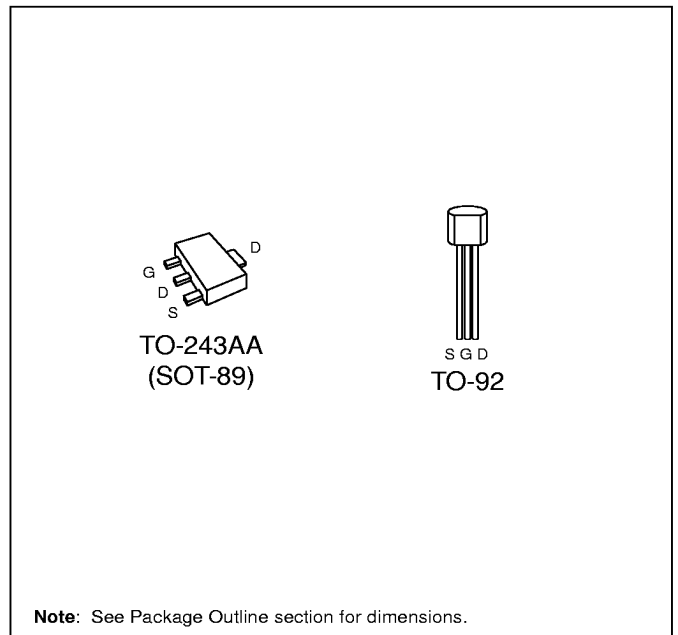

Thermal Characteristics

Package	I_D (continuous)*	I_D (pulsed)	Power Dissipation @ $T_A = 25^\circ\text{C}$	θ_{jc} $^\circ\text{C/W}$	θ_{ja} $^\circ\text{C/W}$	I_{DR}^*	I_{DRM}
TO-92	175mA	500mA	0.74W	125	170	175mA	500mA
TO-243AA	200mA	500mA	1.6†	15	78†	200mA	500mA

* I_D (continuous) is limited by max rated T_j .

† Mounted on FR4 board, 25mm x 25mm x 1.57mm. Significant P_D increase possible on ceramic substrate.

Electrical Characteristics (@ 25°C unless otherwise specified)

Symbol	Parameter	Min	Typ	Max	Unit	Conditions
BV_{DSX}	Drain-to-Source Breakdown Voltage	300			V	$V_{GS} = -5V, I_D = 100\mu\text{A}$
$V_{GS(OFF)}$	Gate-to-Source OFF Voltage	-1.0		-3.5	V	$V_{DS} = 25V, I_D = 10\mu\text{A}$
$\Delta V_{GS(OFF)}$	Change in $V_{GS(OFF)}$ with Temperature			4.5	mV/ $^\circ\text{C}$	$V_{DS} = 25V, I_D = 10\mu\text{A}$
I_{GSS}	Gate Body Leakage Current			100	nA	$V_{GS} = \pm 20V, V_{DS} = 0V$
$I_{D(OFF)}$	Drain-to-Source Leakage Current			10	μA	$V_{GS} = -10V, V_{DS} = \text{Max Rating}$
				1	mA	$V_{GS} = -10V, V_{DS} = 0.8 \text{ Max Rating}$ $T_A = 125^\circ\text{C}$
I_{DSS}	Saturated Drain-to-Source Current	200			mA	$V_{GS} = 0V, V_{DS} = 25V$
$R_{DS(ON)}$	Static Drain-to-Source ON-State Resistance			12	Ω	$V_{GS} = 0V, I_D = 150\text{mA}$
$\Delta R_{DS(ON)}$	Change in $R_{DS(ON)}$ with Temperature			1.1	%/ $^\circ\text{C}$	$V_{GS} = 0V, I_D = 150\text{mA}$
G_{FS}	Forward Transconductance	300			m Ω	$I_D = 150\text{mA}, V_{DS} = 10V$
C_{ISS}	Input Capacitance			300	pF	$V_{GS} = -10V, V_{DS} = 25V$ $f = 1 \text{ MHz}$
C_{OSS}	Common Source Output Capacitance			30		
C_{RSS}	Reverse Transfer Capacitance			5		
$t_{d(ON)}$	Turn-ON Delay Time			10	ns	$V_{DD} = 25V,$ $I_D = 150\text{mA},$ $R_{GEN} = 25\Omega$
t_r	Rise Time			15		
$t_{d(OFF)}$	Turn-OFF Delay Time			15		
t_f	Fall Time			20		
V_{SD}	Diode Forward Voltage Drop			1.8	V	$V_{GS} = -10V, I_{SD} = 150\text{mA}$
t_{rr}	Reverse Recovery Time		600		ns	$V_{GS} = -10V, I_{SD} = 1A$

Notes:

- All D.C. parameters 100% tested at 25°C unless otherwise stated. (Pulse test: 300 μs pulse, 2% duty cycle.)
- All A.C. parameters sample tested.

Switching Waveforms and Test Circuit

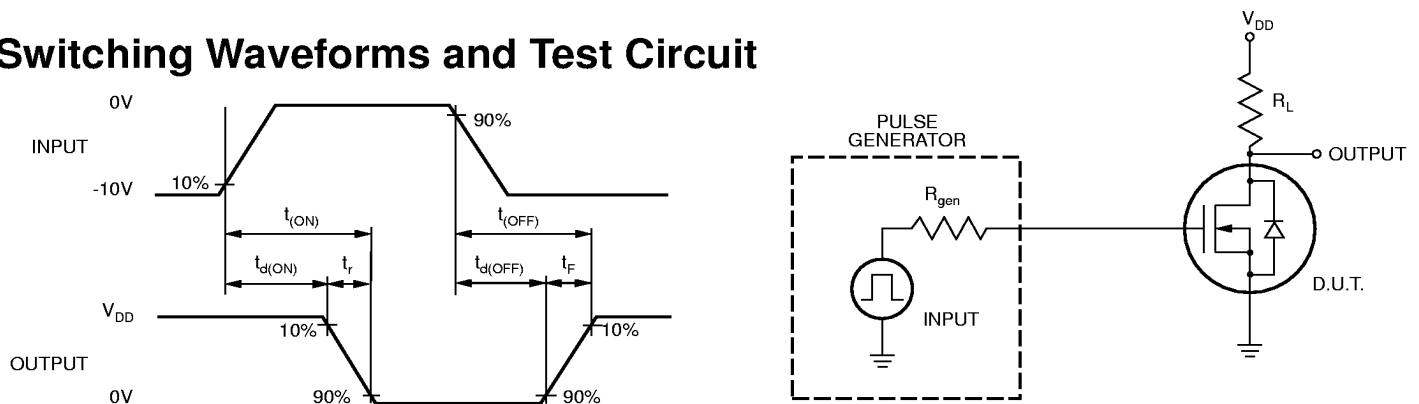

Typical Performance Curves

Output Characteristics

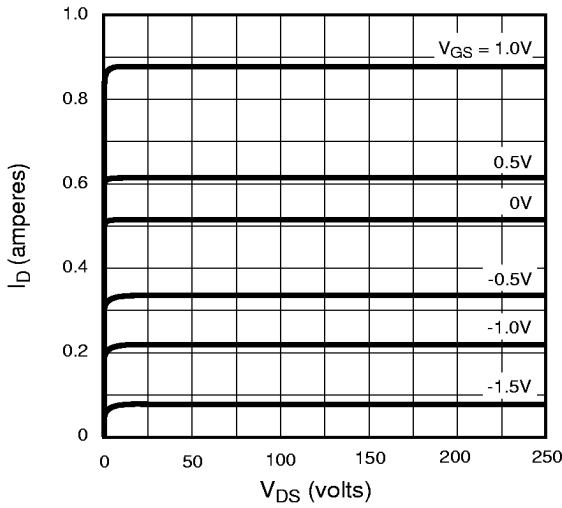

Saturation Characteristics

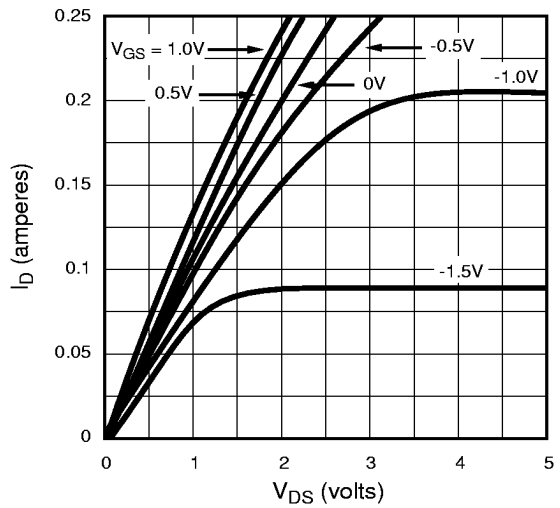

Transconductance vs. Drain Current

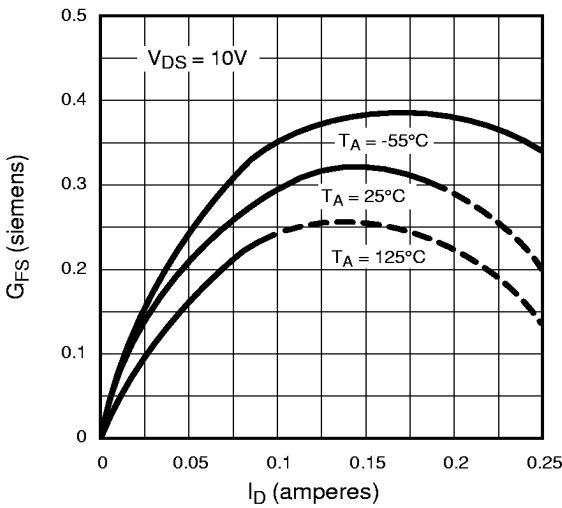

Power Dissipation vs. Case Temperature

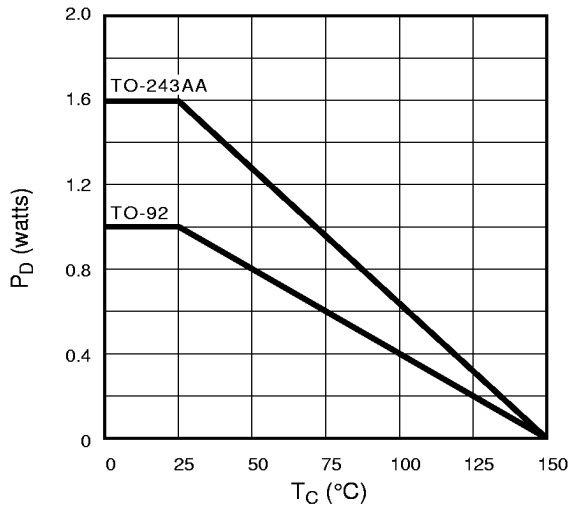

Maximum Rated Safe Operating Area

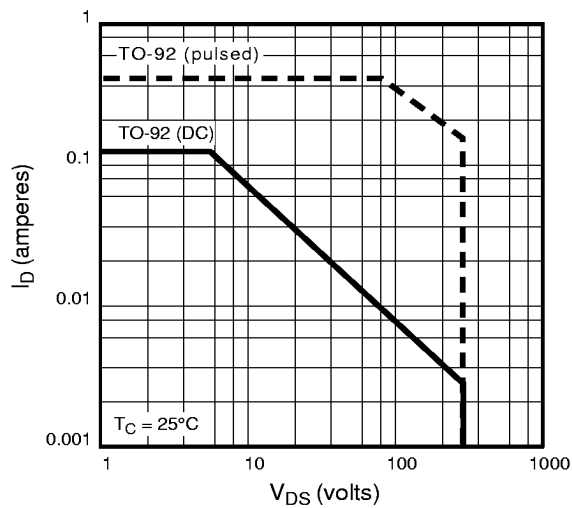

Thermal Response Characteristics

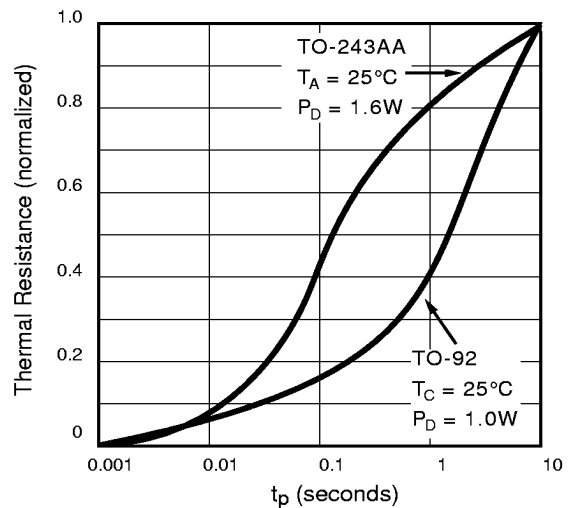

Typical Performance Curves

