

2SC3858

Silicon NPN Triple Diffused Planar Transistor (Complement to type 2SA1494)

Application : Audio and General Purpose

Absolute maximum ratings (Ta=25°C)

Symbol	2SC3858	Unit
V _{CB0}	200	V
V _{CEO}	200	V
V _{EB0}	6	V
I _C	17	A
I _B	5	A
P _C	200(T _C =25°C)	W
T _J	150	°C
T _{stg}	-55 to +150	°C

Electrical Characteristics (Ta=25°C)

Symbol	Conditions	2SC3858	Unit
I _{CB0}	V _{CB} =200V	100max	μA
I _{EB0}	V _{EB} =6V	100max	μA
V(BR) _{CEO}	I _C =50mA	200min	V
h _{FE}	V _{CE} =4V, I _C =8A	50min*	
V _{CE(sat)}	I _C =10A, I _B =1A	2.5max	V
f _r	V _{CE} =12V, I _E =-1A	20typ	MHz
C _{OB}	V _{CB} =10V, f=1MHz	300typ	pF

*h_{FE} Rank Y(50 to 100), P(70 to 140), G(90 to 180)

Typical Switching Characteristics (Common Emitter)

V _{CC} (V)	R _L (Ω)	I _C (A)	V _{BB1} (V)	V _{BB2} (V)	I _{B1} (A)	I _{B2} (A)	t _{on} (μs)	t _{stg} (μs)	t _f (μs)
40	4	10	10	-5	1	-1	0.5typ	1.8typ	0.6typ

External Dimensions MT-200

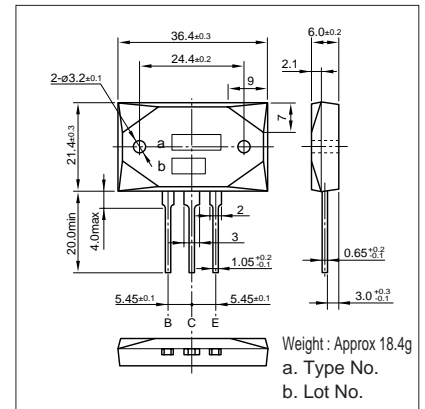

I_C-V_{CE} Characteristics (Typical)

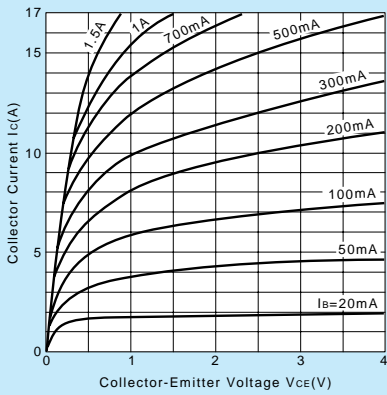

V_{CE(sat)}-I_B Characteristics (Typical)

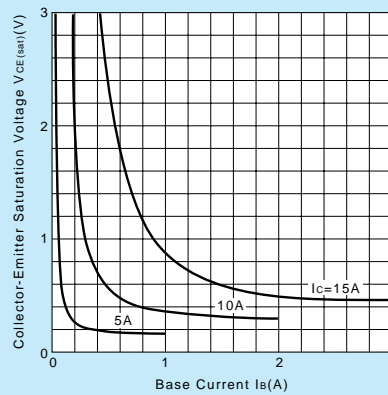

I_C-V_{BE} Temperature Characteristics (Typical)

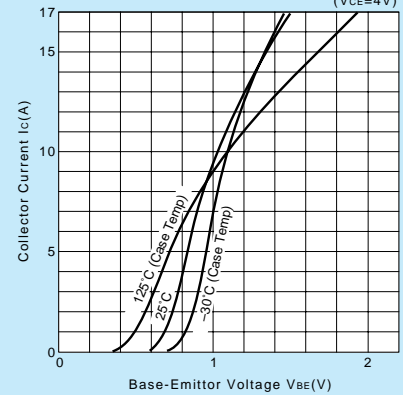

h_{FE}-I_C Characteristics (Typical)

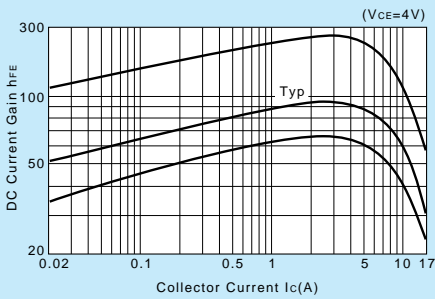

h_{FE}-I_C Temperature Characteristics (Typical)

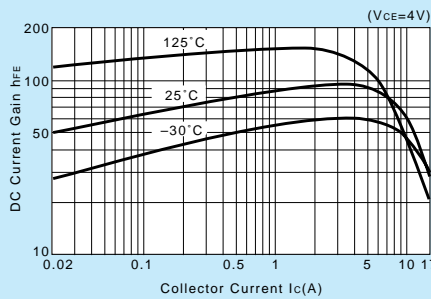

θ_{j-a}-t Characteristics

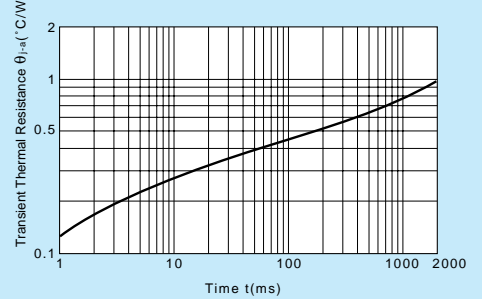

f_T-I_E Characteristics (Typical)

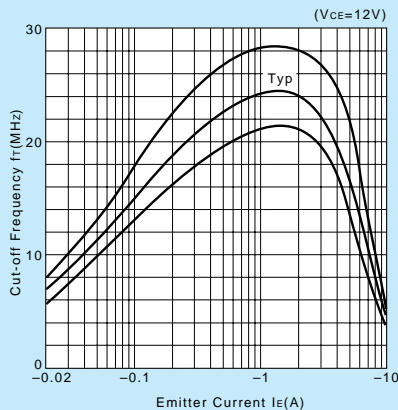

Safe Operating Area (Single Pulse)

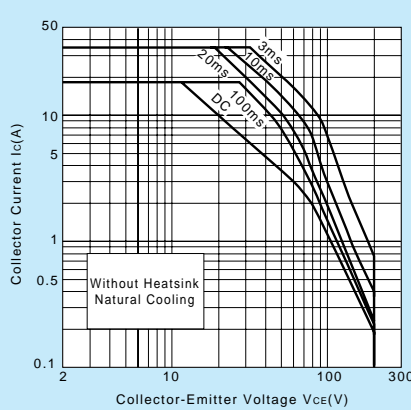

P_C-T_a Derating

