

# Single analog switch

## BU4S66

The BU4S66 is an ultra-compact IC with one circuit of the bi-directional analog switch BU4066B built into an SMP package. Setting the enable input (CONT) to the "H" level sets the impedance between the switch input and the output pins low (ON state) and setting CONT to the "L" level sets the impedance high (OFF state).

●Features

- 1) Low current dissipation.
- 2) Super-mini mold package designed for surface mounting.
- 3) Wide range of operating power supply voltage.
- 4) Direct drive of 2 L-TTL inputs and 1 LS-TTL input.

●Block diagram

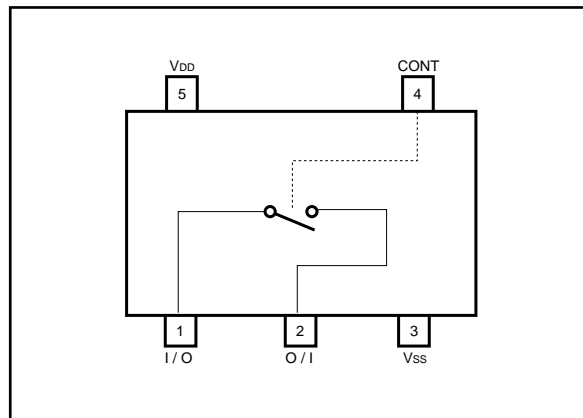

●Absolute maximum ratings (Ta = 25°C)

Parameter	Symbol	Limits	Unit
Power supply voltage	V <sub>DD</sub>	V <sub>SS</sub> - 0.3 ~ V <sub>SS</sub> + 18	V
Power dissipation	P <sub>d</sub>	170	mW
Input current	I <sub>IN</sub>	± 10	mA
Operating temperature	T <sub>opr</sub>	- 40 ~ + 85	°C
Storage temperature	T <sub>stg</sub>	- 55 ~ + 150	°C
Input voltage	V <sub>IN</sub>	V <sub>SS</sub> - 0.3 ~ V <sub>DD</sub> + 0.3	V

\*1 These values indicate the range limits of the voltage that can be applied to each pin without destroying it. Operation is not guaranteed at these values.

\*2 Reduced by 1.7mW for each increase in Ta of 1°C over 25°C.

●Recommended operating conditions (Ta = 25°C, V<sub>SS</sub> = 0V)

Parameter	Symbol	Min.	Typ.	Max.	Unit
Power supply voltage	V <sub>DD</sub>	3	—	16	V
Input voltage	V <sub>IN</sub>	0	—	V <sub>DD</sub>	V

●Electrical characteristics

DC characteristics (unless otherwise noted, V<sub>SS</sub> = 0V, Ta = 25°C)

Parameter	Symbol	Min.	Typ.	Max.	Unit	V <sub>DD</sub> (V)	Conditions	Measurement circuit
Control input high level voltage	V <sub>IH</sub>	3.5	—	—	V	5	Current between input and output = 10μA	Fig.1
		7.0	—	—	V	10		
		11.0	—	—	V	15		
Control input low level voltage	V <sub>IL</sub>	—	—	1.5	V	5	Current between input and output = 10μA	Fig.1
		—	—	3.0	V	10		
		—	—	4.0	V	15		
ON resistance	R <sub>ON</sub>	—	290	950	Ω	5	0 ≦ V <sub>IN</sub> ≦ V <sub>DD</sub> R <sub>L</sub> = 10kΩ	Fig.2
		—	120	250	Ω	10		
		—	85	160	Ω	15		
OFF-channel leakage current	I <sub>off</sub>	—	—	0.3	μA	15	V <sub>IN</sub> = 15V, V <sub>OUT</sub> = 0V	Fig.3
		—	—	- 0.3		15	V <sub>IN</sub> = 0V, V <sub>OUT</sub> = 15V	
Static current dissipation	I <sub>DD</sub>	—	—	1.0	μA	5	V <sub>IN</sub> = V <sub>DD</sub> or GND	—
		—	—	2.0		10		
		—	—	4.0		15		
Input capacitance (control input)	C <sub>C</sub>	—	8	—	pF	—	f = 1MHz	—
Input capacitance (switch input)	C <sub>S</sub>	—	10	—	pF	—	f = 1MHz	—

Switching characteristics (unless otherwise noted,  $V_{SS} = 0V$ ,  $T_a = 25^\circ C$ )

Parameter	Symbol	Min.	Typ.	Max.	Unit	Conditions		Measurement circuit	
						$V_{DD}$ (V)	$V_{SS}$ (V)		
Propagation delay time (I / O → O / I)	$t_{PLH}$	—	15	—	ns	5	$R_L = 10k\Omega$ $C_L = 50pF$	Fig.4	
		—	8	—	ns	10			
		—	5	—	ns	15			
	$t_{PHL}$	—	15	—	ns	5			
		—	8	—	ns	10			
		—	5	—	ns	15			
Propagation delay time (CONTROL → O / I)	$t_{PHZ}$	—	100	—	ns	5	$R_L = 10k\Omega$ $C_L = 50pF$	Fig.5	
		—	70	—	ns	10			
		—	65	—	ns	15			
	$t_{PLZ}$	—	100	—	ns	5	$R_L = 10k\Omega$ $C_L = 50pF$	Fig.6	
		—	70	—	ns	10			
		—	65	—	ns	15			
	$t_{PZH}$	—	80	—	ns	5	$R_L = 10k\Omega$ $C_L = 50pF$	Fig.5	
		—	35	—	ns	10			
		—	25	—	ns	15			
	$t_{PZL}$	—	80	—	ns	5	$R_L = 10k\Omega$ $C_L = 50pF$	Fig.6	
		—	35	—	ns	10			
		—	25	—	ns	15			
Maximum control frequency	$f_{Max.} (C)$	—	10	—	MHz	5	$R_L = 1k\Omega$ $C_L = 50pF$	—	
		—	12	—	MHz	10			
		—	12	—	MHz	15			
Max. propagation frequency	$f_{Max.} (I - O)^{*1}$	—	30	—	MHz	5	-5	$R_L = 1k\Omega$ $C_L = 50pF$	—
Feedthrough attenuation	F.T. $^{*2}$	—	600	—	kHz	5	-5	$R_L = 1k\Omega$	Fig.7
Sinewave distortion (1kHz)	THD $^{*3}$	—	0.05	—	%	5	-5	$R_L = 10k\Omega$ $C_L = 50pF$	
Crosstalk (CONTROL → O / I)	$CT_C$	—	200	—	mV	5	$R_{IN} = 1k\Omega$ $R_{OUT} = 10k\Omega$ $C_L = 15pF$	Fig.8	
		—	400	—	mV	10			
		—	600	—	mV	15			

\*1 Frequency that enables  $20 \log (V_{OUT} / V_{IN}) = -3dB$ \*2 Frequency that enables  $20 \log (V_{OUT} / V_{IN}) = -50dB$ \*1 \*2 \*3 Use a  $V_{IN} = \pm 2.5V_{PP}$  sine wave.

●Measurement circuits

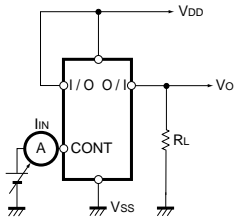

Fig. 1 Input voltage, current

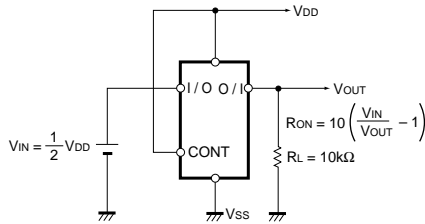

Fig. 2 ON resistance

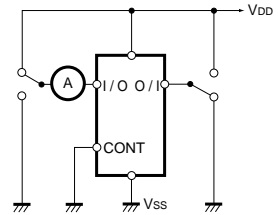

Fig. 3 Channel OFF leakage current

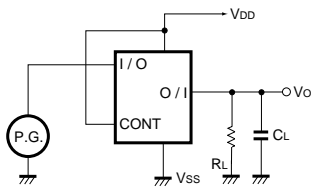

Fig. 4 Switching characteristic measurement circuit

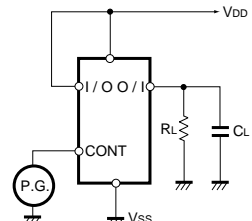
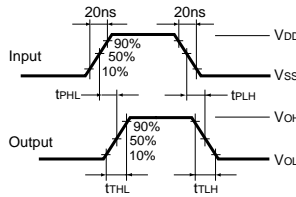

Fig. 5 Propagation delay time (CONT→OUT)

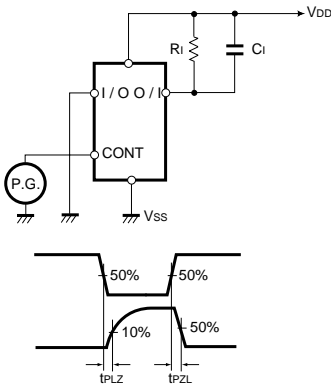
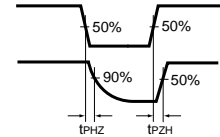

Fig. 6 Propagation delay time (CONT→OUT)

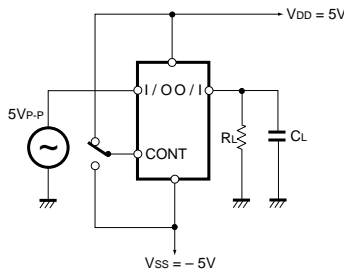

Fig. 7 Sine wave distortion, feedthrough attenuation

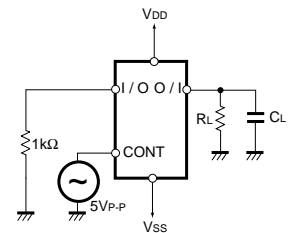
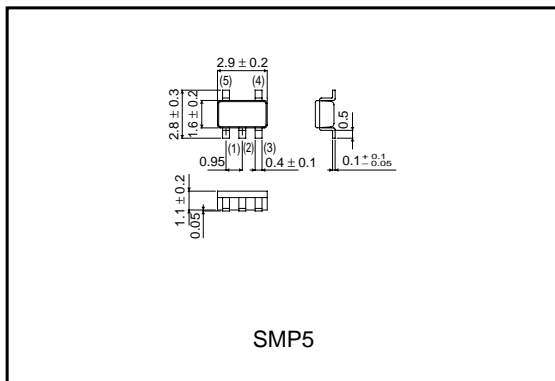

Fig. 8 Control IN→OUT crosstalk

●External dimensions (Units: mm)



SMP5