

HEXFRED™

Ultrafast, Soft Recovery Diode

Features

- Ultrafast Recovery
- Ultrasoft Recovery
- Very Low I_{RRM}
- Very Low Q_{rr}
- Specified at Operating Conditions

Benefits

- Reduced RFI and EMI
- Reduced Power Loss in Diode and Switching Transistor
- Higher Frequency Operation
- Reduced Snubbing
- Reduced Parts Count

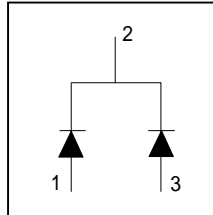

$V_R = 600V$
$V_F(\text{typ.})^* = 1.2V$
$I_{F(AV)} = 15A$
$Q_{rr}(\text{typ.}) = 80nC$
$I_{RRM}(\text{typ.}) = 4.0A$
$t_{rr}(\text{typ.}) = 19ns$
$di_{(rec)M}/dt(\text{typ.})^* = 160A/\mu s$

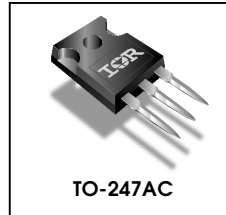

Description

International Rectifier's HFA30PA60C is a state of the art center tap ultra fast recovery diode. Employing the latest in epitaxial construction and advanced processing techniques it features a superb combination of characteristics which result in performance which is unsurpassed by any rectifier previously available. With basic ratings of 600 volts and 15 amps per Leg continuous current, the HFA30PA60C is especially well suited for use as the companion diode for IGBTs and MOSFETs. In addition to ultra fast recovery time, the HEXFRED product line features extremely low values of peak recovery current (I_{RRM}) and does not exhibit any tendency to "snap-off" during the t_b portion of recovery. The HEXFRED features combine to offer designers a rectifier with lower noise and significantly lower switching losses in both the diode and the switching transistor. These HEXFRED advantages can help to significantly reduce snubbing, component count and heatsink sizes. The HEXFRED HFA30PA60C is ideally suited for applications in power supplies and power conversion systems (such as inverters), motor drives, and many other similar applications where high speed, high efficiency is needed.

Absolute Maximum Ratings (per Leg)

	Parameter	Max.	Units
V_R	Cathode-to-Anode Voltage	600	V
$I_F @ T_C = 100^\circ C$	Continuous Forward Current	15	A
I_{FSM}	Single Pulse Forward Current	150	
I_{FRM}	Maximum Repetitive Forward Current	60	
$P_D @ T_C = 25^\circ C$	Maximum Power Dissipation	74	W
$P_D @ T_C = 100^\circ C$	Maximum Power Dissipation	29	
T_J	Operating Junction and	-55 to +150	C
T_{STG}	Storage Temperature Range		

* 125°C

Electrical Characteristics (per Leg) @ T_J = 25°C (unless otherwise specified)

	Parameter	Min.	Typ.	Max.	Units	Test Conditions
V _{BR}	Cathode Anode Breakdown Voltage	600	—	—	V	I _R = 100μA
V _{FM}	Max Forward Voltage	—	1.3	1.7	V	I _F = 15A
		—	1.5	2.0		I _F = 30A See Fig. 1
		—	1.2	1.6		I _F = 15A, T _J = 125°C
I _{RM}	Max Reverse Leakage Current	—	1.0	10	μA	V _R = V _R Rated See Fig. 2
		—	400	1000		T _J = 125°C, V _R = 0.8 x V _R Rated
C _T	Junction Capacitance	—	25	50	pF	V _R = 200V See Fig. 3
L _S	Series Inductance	—	12	—	nH	Measured lead to lead 5mm from package body

Dynamic Recovery Characteristics (per Leg) @ T_J = 25°C (unless otherwise specified)

	Parameter	Min.	Typ.	Max.	Units	Test Conditions
t _{rr}	Reverse Recovery Time	—	19	—	ns	I _F = 1.0A, di _F /dt = 200A/μs, V _R = 30V
t _{rr1}	See Fig. 5, 10	—	42	60		T _J = 25°C
t _{rr2}		—	70	120		T _J = 125°C
I _{RRM1}	Peak Recovery Current	—	4.0	6.0	A	I _F = 15A V _R = 200V
		—	6.5	10		
I _{RRM2}	See Fig. 6	—	6.5	10	A	T _J = 125°C
Q _{rr1}	Reverse Recovery Charge	—	80	180	nC	T _J = 25°C
Q _{rr2}		See Fig. 7	—	220		600
di _{(rec)M} /dt1	Peak Rate of Fall of Recovery Current	—	250	—	A/μs	T _J = 25°C
di _{(rec)M} /dt2		During t _b See Fig. 8	—	160		—

Thermal - Mechanical Characteristics (per Leg)

	Parameter	Min.	Typ.	Max.	Units
T _{lead} ①	Lead Temperature	—	—	300	°C
R _{thJC}	Junction-to-Case, Single Leg Conducting	—	—	1.7	K/W
	Junction-to-Case, Both Legs Conducting	—	—	0.85	
R _{thJA} ②	Thermal Resistance, Junction to Ambient	—	—	40	
R _{thCS} ③	Thermal Resistance, Case to Heat Sink	—	0.25	—	
Wt	Weight	—	6.0	—	g
		—	0.21	—	(oz)
	Mounting Torque	—	6.0	12	Kg-cm
		—	5.0	10	lbf-in

① 0.063 in. from Case (1.6mm) for 10 sec

② Typical Socket Mount

③ Mounting Surface, Flat, Smooth and Greased

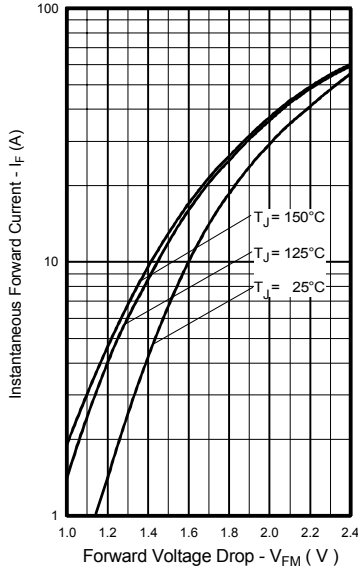

Fig. 1 - Maximum Forward Voltage Drop vs. Instantaneous Forward Current, (per Leg)

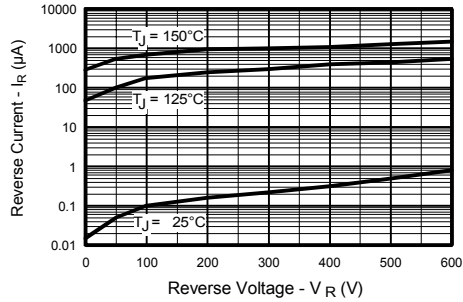

Fig. 2 - Typical Reverse Current vs. Reverse Voltage, (per Leg)

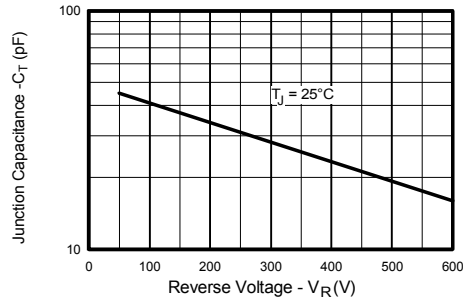

Fig. 3 - Typical Junction Capacitance vs. Reverse Voltage, (per Leg)

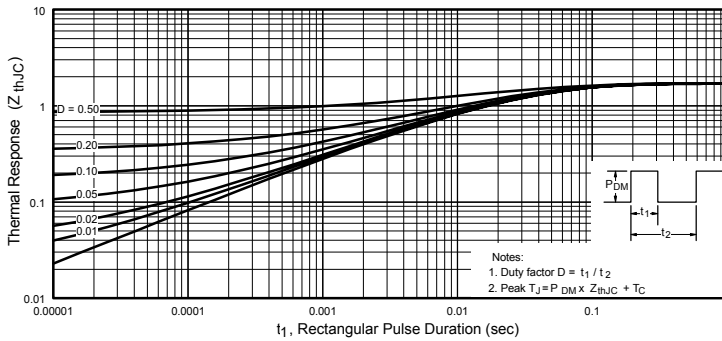

Fig. 4 - Maximum Thermal Impedance Z_{thJC} Characteristics, (per Leg)

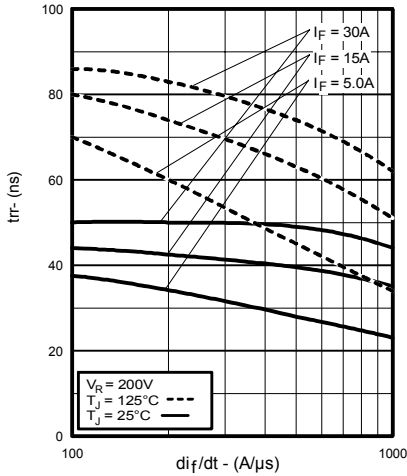

Fig. 5 - Typical Reverse Recovery Time vs. di_f/dt , (per Leg)

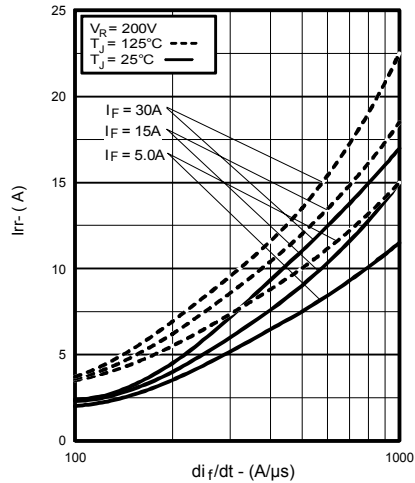

Fig. 6 - Typical Recovery Current vs. di_f/dt , (per Leg)

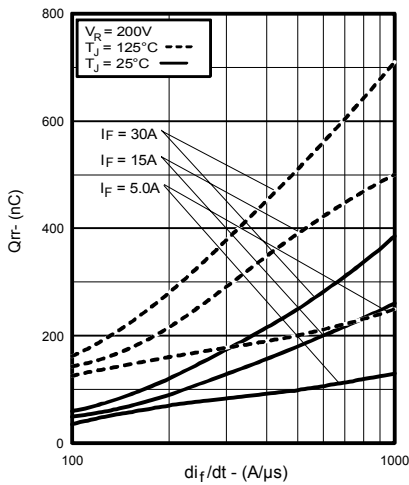

Fig. 7 - Typical Stored Charge vs. di_f/dt , (per Leg)

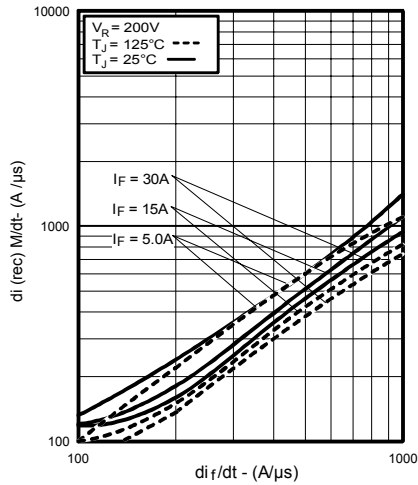

Fig. 8 - Typical $di_{(rec)}M/dt$ vs. di_f/dt , (per Leg)

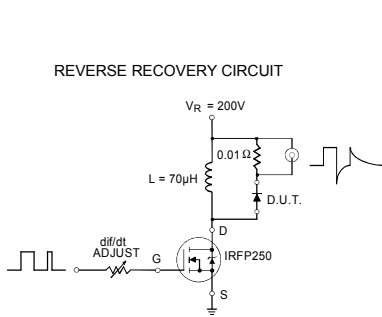

Fig. 9 - Reverse Recovery Parameter Test Circuit

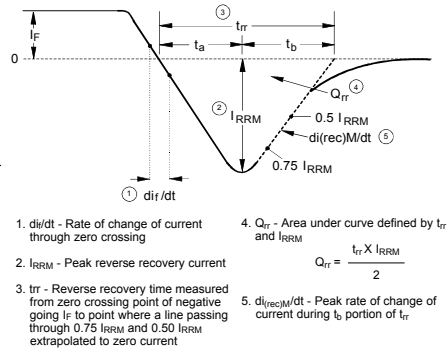

Fig. 10 - Reverse Recovery Waveform and Definitions

Ordering Information Table

Device Code					
HF	A	30	PA	60	C
①	②	③	④	⑤	⑥
1	- Hexfred Family				
2	- Process Designator	A	= subs. elec. irradi.		
		B	= subs. Platinum		
3	- Current Rating	(30	= 30A)		
4	- Package Outline	(PA	= TO-247, 3 pins)		
5	- Voltage Rating	(60	= 600V)		
6	- Configuration	(C	= Center Tap Common Cathode)		

HFA30PA60C

Bulletin PD -2.336 rev. C 05/01

International
IR Rectifier

Outline Table

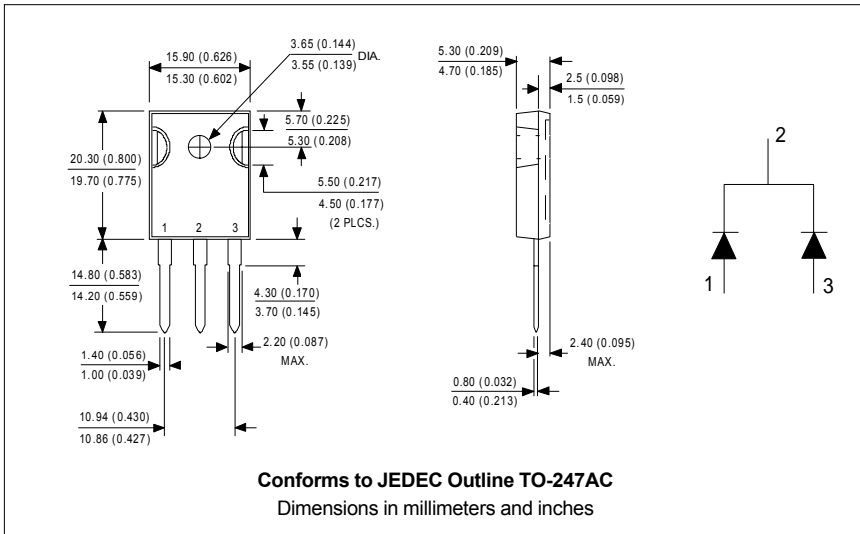

Data and specifications subject to change without notice.
This product has been designed and qualified for Industrial Level.
Qualification Standards can be found on IR's Web site.

International
IR Rectifier

IR WORLD HEADQUARTERS: 233 Kansas St., El Segundo, California 90245, USA Tel: (310) 252-7105
TAC Fax: (310) 252-7309
Visit us at www.irf.com for sales contact information. 05/01