

$$V_{DS} = 200 \text{ V}$$

$$I_D = 2 \times 81 \text{ A}$$

$$R_{DS(on)} = 0.03 \text{ } \Omega$$

- Power module
- Half-bridge
- N channel
- Enhancement mode
- Package with insulated metal base plate
- Package outline/Circuit diagram: 2a¹⁾

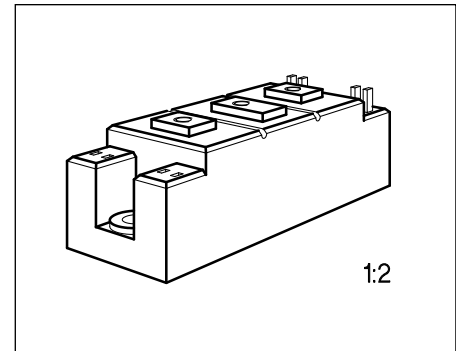

Type	Ordering Code
BSM 224 A	C67076-S1101-A2

Maximum Ratings

Parameter	Symbol	Values	Unit
Drain-source voltage	V_{DS}	200	V
Drain-gate voltage, $R_{GS} = 20 \text{ k}\Omega$	V_{DGR}	200	
Gate-source voltage	V_{GS}	± 20	
Continuous drain current, $T_C = 25 \text{ }^\circ\text{C}$	I_D	81	A
Pulsed drain current, $T_C = 25 \text{ }^\circ\text{C}$	$I_{D \text{ puls}}$	250	
Operating and storage temperature range	T_j, T_{stg}	$- 55 \dots + 150$	$^\circ\text{C}$
Power dissipation, $T_C = 25 \text{ }^\circ\text{C}$	P_{tot}	400	W
Thermal resistance Chip-case	$R_{th \text{ JC}}$	≤ 0.31	K/W
Insulation test voltage ²⁾ , $t = 1 \text{ min.}$	V_{is}	2500	V_{ac}
Creepage distance, drain-source	–	16	mm
Clearance, drain-source	–	11	
DIN humidity category, DIN 40 040	–	F	–
IEC climatic category, DIN IEC 68-1	–	55/150/56	

¹⁾ See chapter Package Outline and Circuit Diagrams.

²⁾ Insulation test voltage between drain and base plate referred to standard climate 23/50 in acc. with DIN 50 014, IEC 146, para. 492.1.

Electrical Characteristics

at $T_j = 25\text{ °C}$, unless otherwise specified.

Parameter	Symbol	Values			Unit
		min.	typ.	max.	

Static Characteristics

Drain-source breakdown voltage $V_{GS} = 0, I_D = 0.25\text{ mA}$	$V_{(BR)DSS}$	200	–	–	V
Gate threshold voltage $V_{GS} = V_{DS}, I_D = 1\text{ mA}$	$V_{GS(th)}$	2.1	3.0	4.0	
Zero gate voltage drain current $V_{DS} = 200\text{ V}, V_{GS} = 0$ $T_j = 25\text{ °C}$ $T_j = 125\text{ °C}$	I_{DSS}	– –	50 300	250 1000	μA
Gate-source leakage current $V_{GS} = 20\text{ V}, V_{DS} = 0$	I_{GSS}	–	10	100	nA
Drain-source on-state resistance $V_{GS} = 10\text{ V}, I_D = 50\text{ A}$	$R_{DS(on)}$	–	0.023	0.03	Ω

Dynamic Characteristics

Forward transconductance $V_{DS} \geq 2 \times I_D \times R_{DS(on)max.}, I_D = 50\text{ A}$	g_{fs}	40	58	–	S
Input capacitance $V_{GS} = 0, V_{DS} = 25\text{ V}, f = 1\text{ MHz}$	C_{iss}	–	7	9	nF
Output capacitance $V_{GS} = 0, V_{DS} = 25\text{ V}, f = 1\text{ MHz}$	C_{oss}	–	2.5	4	
Reverse transfer capacitance $V_{GS} = 0, V_{DS} = 25\text{ V}, f = 1\text{ MHz}$	C_{rss}	–	0.8	1.5	
Turn-on time t_{on} ($t_{on} = t_{d(on)} + t_r$) $V_{CC} = 100\text{ V}, V_{GS} = 10\text{ V}$ $I_D = 52\text{ A}, R_{GS} = 3.3\text{ }\Omega$	$t_{d(on)}$	–	55	–	ns
	t_r	–	110	–	
Turn-off time t_{off} ($t_{off} = t_{d(off)} + t_f$) $V_{CC} = 100\text{ V}, V_{GS} = 10\text{ V}$ $I_D = 52\text{ A}, R_{GS} = 3.3\text{ }\Omega$	$t_{d(off)}$	–	220	–	
	t_f	–	35	–	

Electrical Characteristics (cont'd)

at $T_j = 25\text{ °C}$, unless otherwise specified.

Parameter	Symbol	Values			Unit
		min.	typ.	max.	

Reverse diode

Continuous reverse drain current $T_C = 25\text{ °C}$	I_S	–	–	81	A
Pulsed reverse drain current $T_C = 25\text{ °C}$	I_{SM}	–	–	250	
Diode forward on-voltage $I_F = 162\text{ A}$, $V_{GS} = 0$	V_{SD}	–	1.25	1.6	V
Reverse recovery time $I_F = I_S$, $di_F/dt = 100\text{ A}/\mu\text{s}$, $V_R = 100\text{ V}$	t_{rr}	–	320	–	ns
Reverse recovery charge $I_F = I_S$, $di_F/dt = 100\text{ A}/\mu\text{s}$, $V_R = 100\text{ V}$	Q_{rr}	–	4.3	–	μC

Characteristics at $T_j = 25\text{ }^\circ\text{C}$, unless otherwise specified.

Power dissipation $P_{\text{tot}} = f(T_C)$
parameter: $T_j = 150\text{ }^\circ\text{C}$

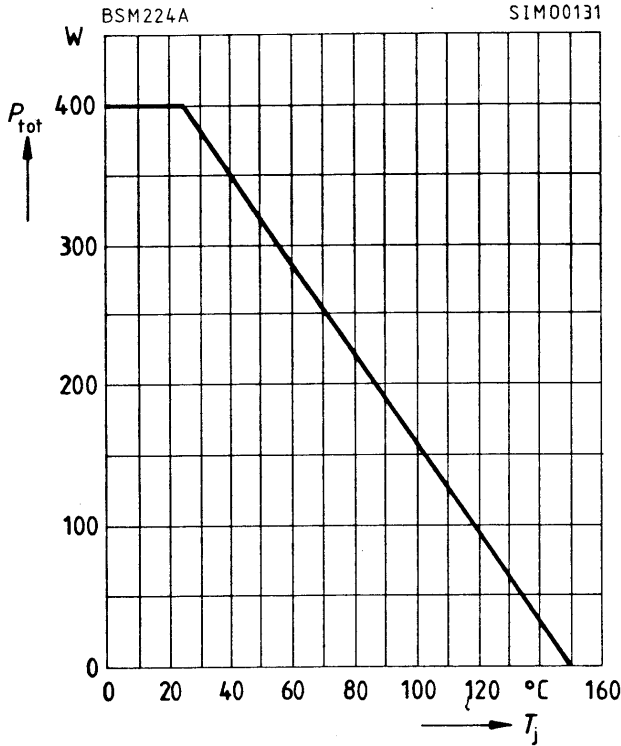

Typ. output characteristics $I_D = f(V_{\text{DS}})$
parameter: $t_p = 80\text{ }\mu\text{s}$

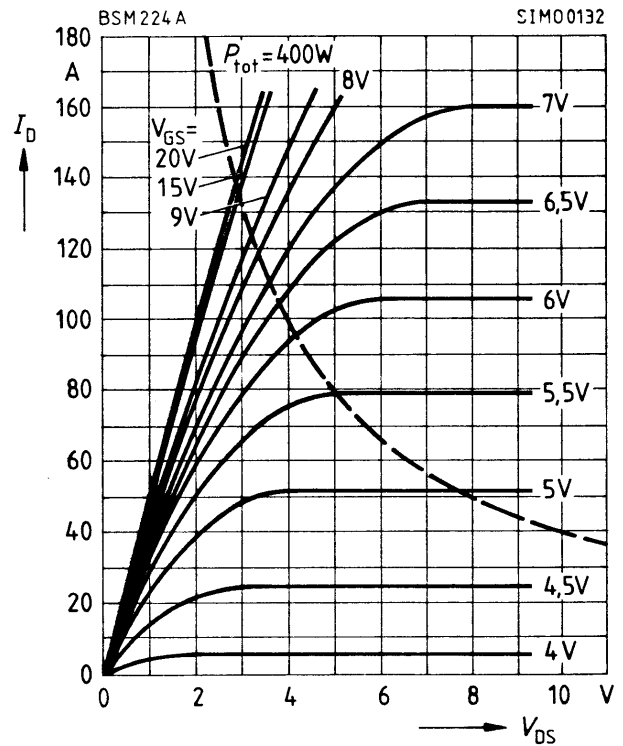

Safe operating area $I_D = f(V_{\text{DS}})$
parameter: single pulse, $T_C = 25\text{ }^\circ\text{C}$
 $T_j \leq 150\text{ }^\circ\text{C}$

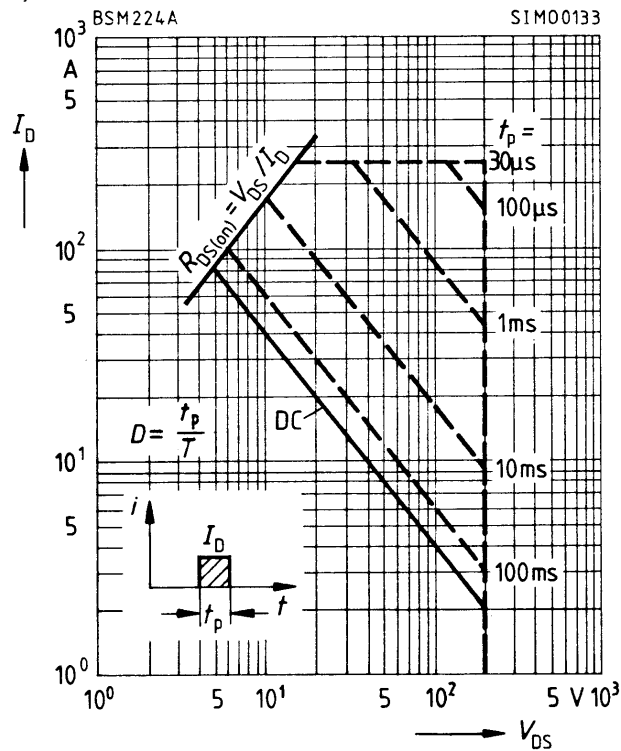

Typ. transfer characteristic $I_D = f(V_{\text{GS}})$
parameter: $t_p = 80\text{ }\mu\text{s}$, $V_{\text{DS}} = 25\text{ V}$

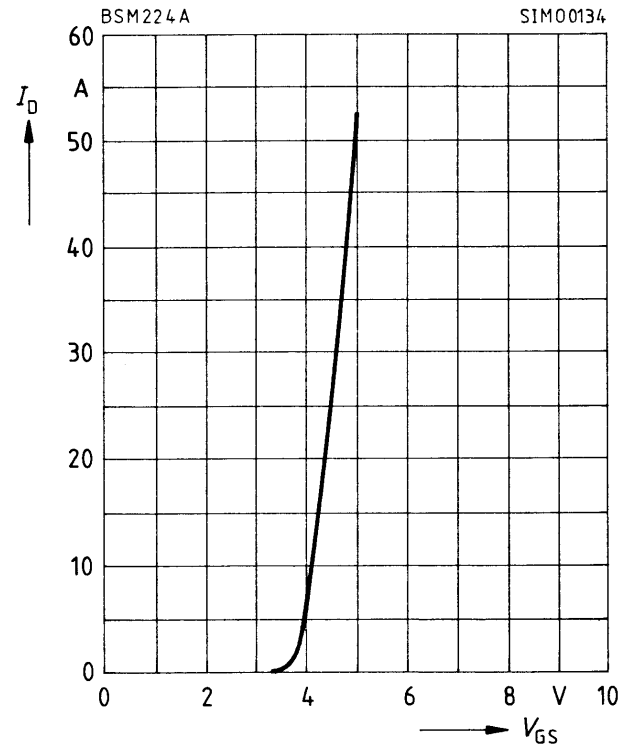

Typ. on-state resistance

$R_{DS(on)} = f(I_D)$

parameter: V_{GS}

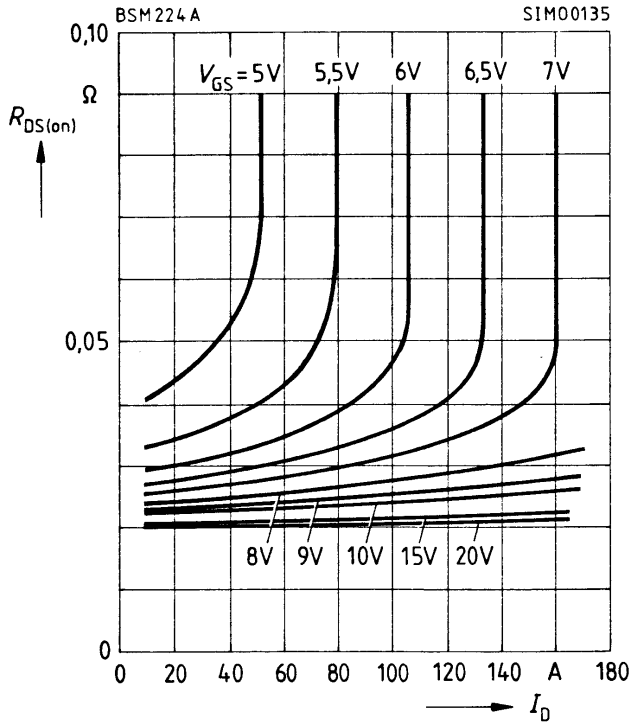

On-state resistance $R_{DS(on)} = f(T_j)$

parameter: $I_D = 50$ A; $V_{GS} = 10$ V (spread)

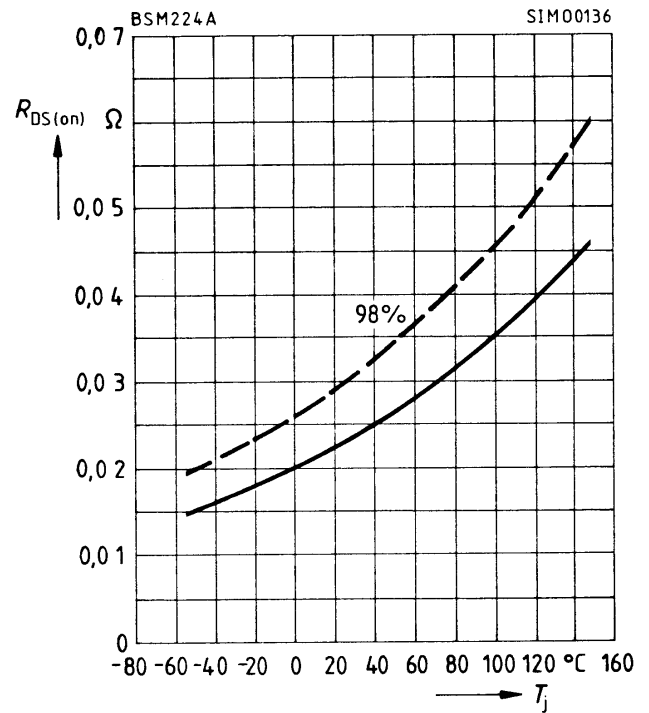

Gate threshold voltage $V_{GS(th)} = f(T_j)$

parameter: $V_{DS} = V_{GS}$, $I_D = 1$ mA (spread)

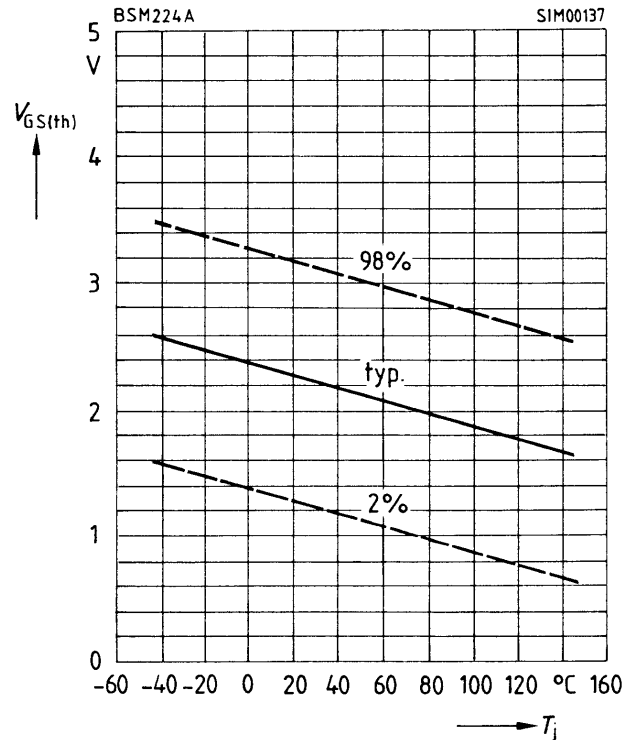

Drain current $I_D = f(T_C)$

parameter: $V_{GS} \geq 10$ V, $T_j = 150$ $^{\circ}C$

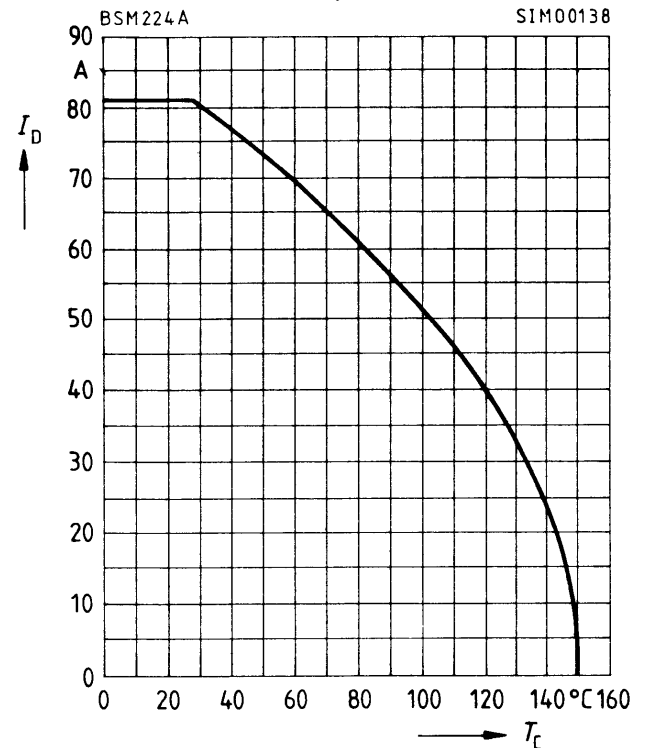

Drain source breakdown voltage

$$V_{(BR)DSS}(T_j) = b \times V_{(BR)DSS}(25^\circ\text{C})$$

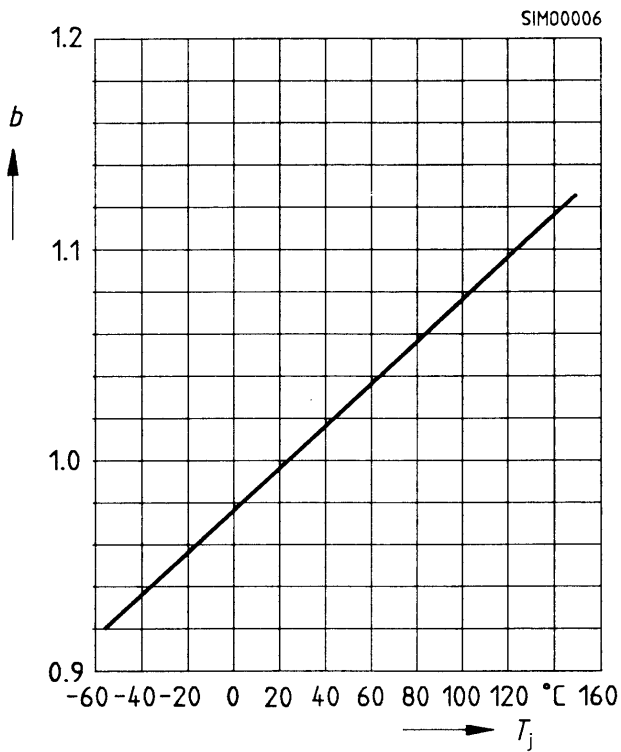

Typ. capacitances $C = f(V_{DS})$

parameter: $V_{GS} = 0, f = 1 \text{ MHz}$ (spread)

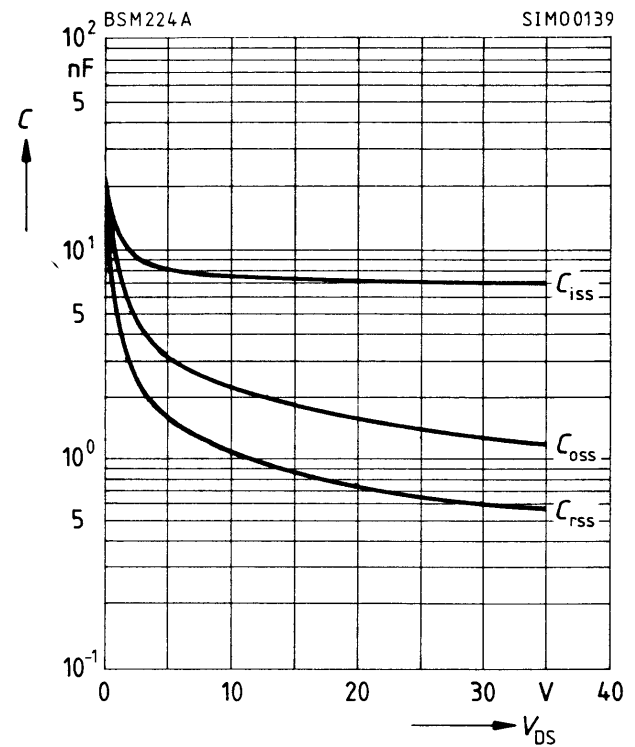

Forward characteristics

of reverse diode $I_F = f(V_{SD})$

parameter: $T_j, t_p = 80 \mu\text{s}$ (spread)

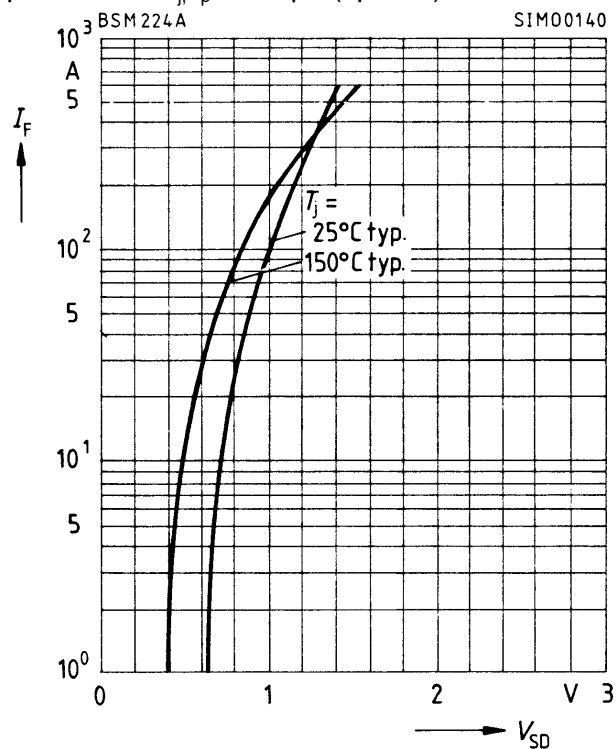

Transient thermal impedance $Z_{thJC} = f(t_p)$

parameter: $D = t_p/T$

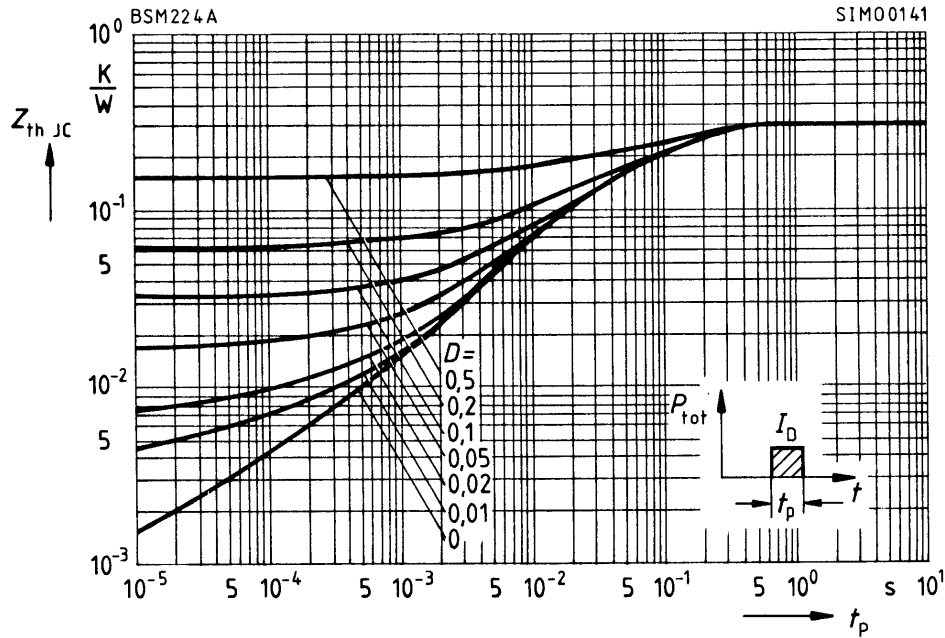

Typ. gate charge $V_{GS} = f(Q_{Gate})$

parameter: $I_{Dpuls} = 121$ A

