

13.56MHz RFID Transponder

Features

- Wide range operating voltage
- Batteryless RF transponder
- Data transmission in read-only operation
- 6-bits sync + 32-bits data + 8-bits CRC
- OTP data memory
- 13.56MHz carrier frequency
- Output data baud rate: 10kbps at $V_{DD}=3V$
- PWM/ASK modulation
- Built-in voltage limiter
- 8-pin DIP package

Applications

- Interactive leisure products
- Security system
- Access control
- Anti-counterfeit devices
- Material management
- Animal management
- Personnel working time record
- Car park monitoring system

General Description

The HT672B is a RF transponder IC operating with 13.56MHz RF carrier, which provides a low cost batteryless transponder solution with the addition of merely an external inductor. The inductor and internal capacitor form a LC tank which inducing voltage from the radiated 13.56MHz carrier signal generated from the reader antenna. HT672B has a built-in low power RC oscillator which is activated if the induced carrier field strength is high enough to supply the operating current and the response signal(pre-programmed in the OTP memory) is serial transmitted out. The response data is transmitted using PWM/ASK modulation. Modulation of 13.56MHz is accomplished by damping the LC tank with a fixed baud rate.

The transmission information is stored in 40 bits. One Time Programmable memory (OTP) (up to 32 bits reserved for customer) in the chip, with a 8-bits checksum code. The effective detection range for a small sized antenna is 2cm~10cm which is dependent on antenna format & reader design. The larger the antenna loop used the longer the detection range. It is advisable to use larger antenna to attain a 15cm detection range. Implementing Holtek's advanced OTP and low power technology, HT672B offers a very cost effective solution for RF contactless detection system. A code area of 32-bits(max.) wide is provided so customers can program the device using the specified programmer supplied by Holtek. The pre-programmed Ics are also available upon customer's request.

Block Diagram

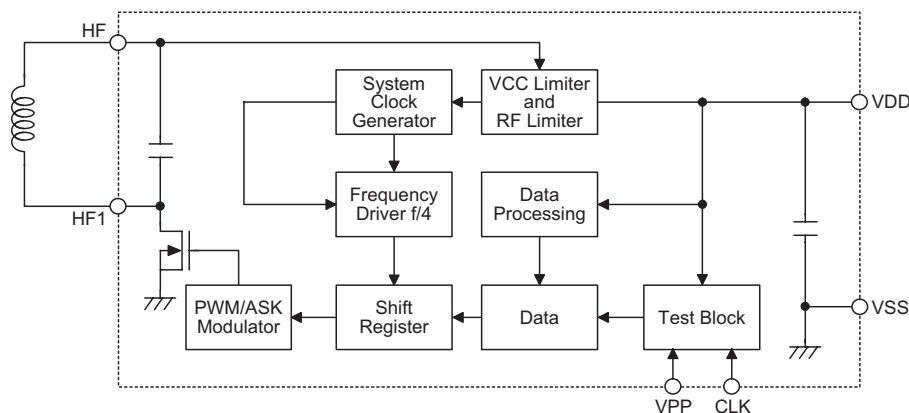

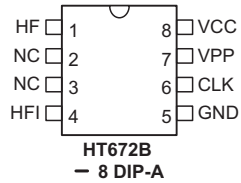
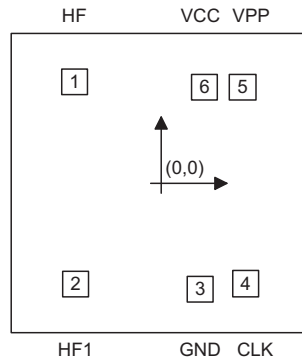
Pin Assignment

Pad Assignment

Chip size: 36.4×36.4 (mil)²

* The IC substrate should be connected to VSS in the PCB layout artwork.

Pad Coordinates

Unit: μm

Pad No.	X	Y	Pad No.	X	Y
1	-252.875	303.663	4	247.074	-297.912
2	-252.875	-298.537	5	238.174	284.663
3	112.975	-314.687	6	126.674	284.663

Pad Description

Pad No.	Pad Name	I/O	Internal Connection	Description
1	HF	I/O	CMOS	Connect to an antenna coil for normal operation. Open for data programming.
2	HF1	I/O	CMOS	Connect to an antenna coil for normal operation. Data I/O for programming.
3	VSS	—	—	Negative power supply, ground
4	CLK	I	CMOS	Open for normal operation. Clock input for programming.
5	VPP	I	—	Open for normal operation. High voltage supplies input for programming. (Suggest 12.5V for programming)
6	VDD	—	—	Open for normal operation, +6V supply input for programming.

Absolute Maximum Ratings

Supply Voltage (VDD)	5.5V	Storage Temperature	-50°C to 125°C
Supply Voltage (VPA)	12.5V	Operating Temperature	0°C to 70°C
Input Voltage	$V_{SS}-0.3V$ to $V_{DD}+0.3V$		

Note: These are stress ratings only. Stresses exceeding the range specified under "Absolute Maximum Ratings" may cause substantial damage to the device. Functional operation of this device at other conditions beyond those listed in the specification is not implied and prolonged exposure to extreme conditions may affect device reliability.

Electrical Characteristics

Symbol	Parameter	Test Conditions		Min.	Typ.	Max.	Unit
		V _{DD}	Conditions				
V _{DD}	Operating Voltage	—	V _{DD} pad voltage	2	3	4	V
I _{DD}	Operating Current	2V	—	—	15	—	μA
I _{DD}	Operating Current	3V	—	—	400	—	μA
R _m	Modulation Resistance	3.3V	—	—	320	—	Ω
V _{LCL}	LC Input Limiter Voltage	—	—	—	6.5	—	V
B _R	Output Data Baud Rate	3V	V _{DD} vs V _{SS}	5	10	15	Kbps

Functional Description

Operation Concept

The reader transmits a 13.56MHz carrier signal from its antenna, the LC tank on the transponder side converts the carrier energy to voltage form and supply to the transponder chip with an internal pump circuit. If the induced energy is high enough, the pumped voltage reaches the break-in voltage of internal RC-oscillator, the transponder is actuated to transmit its internal data serially by means of damping the LC tank.

The reader receiving the transponder's data by means of detecting the energy variation on it's own antenna, and recognize the information with a microcontroller.

The HT672B has a built-in internal Voltage Limiter to prevent excess power supply and RF levels induced by the LC tank from damaging the device or causing the device to function abnormally.

A total of 40 bits of OTP memory space is provided, from which 20 bits wide are customer programmable, which can be programmed using the specified programmer supplied by Holtek. The pre-programmed lcs are also available upon customer's request.

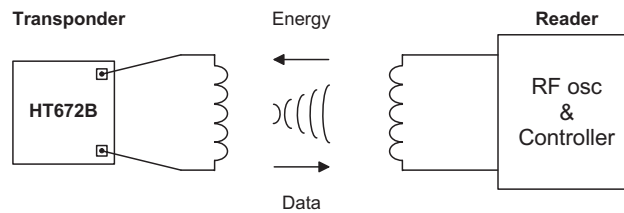

Timing & Code Package

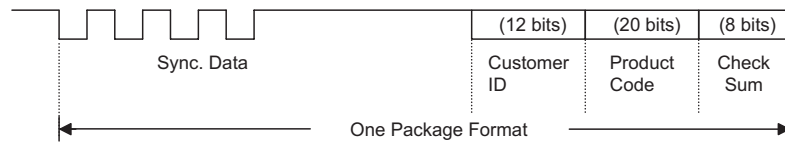

Code Package

A total of 40 bits information can be stored in the HT672B, from which 20 bits are customer programmable.

- Sync. data: Including 4 bits (which low/high duty length is 50%)
- Mark data: 2 bits (always high signal).
- Customer ID: This 12-bit wide code is not customer programmable and is supplied together with the data writer after register to Holtek. The writer generates the code automatically.
- Product code: Storing the contents of the user ID number or data.
- Check sum: A 8 bits of checksum code is generated automatically by the writer.

Application Circuits

Tag

A tag consists of a PCB (or Mylar film) with printed coil, HT672B and a housing. The housing can be of various shapes.

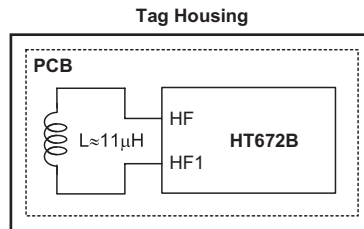

Note: The value of the antenna inductance is 11μH, however the optimum value will be changed slightly due to the variation of the internal resonance capacitor (10pF typically) during process.

For more application information about the reader, refer to Holtek's 13.56MHz RF ID reader data.

2-chip Solution

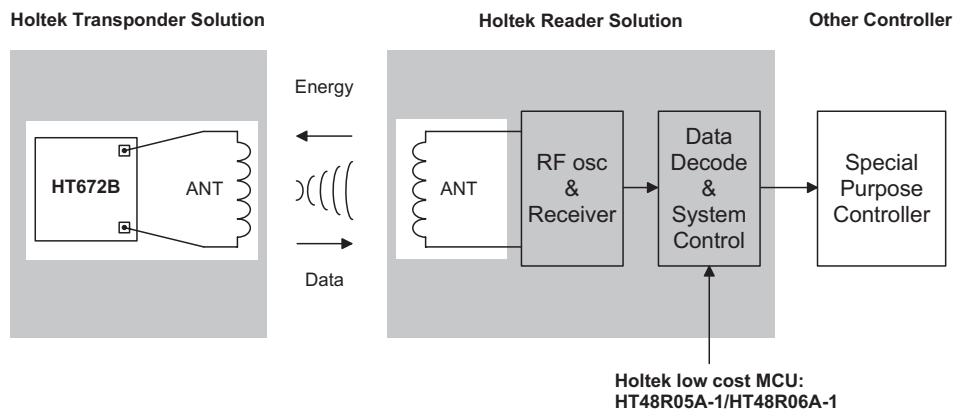

1-chip Solution (I)

Holtek Transponder Solution

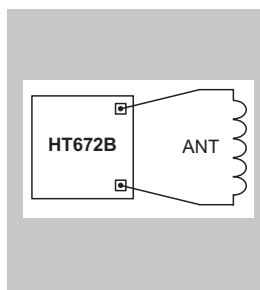

Holtek Reader Solution

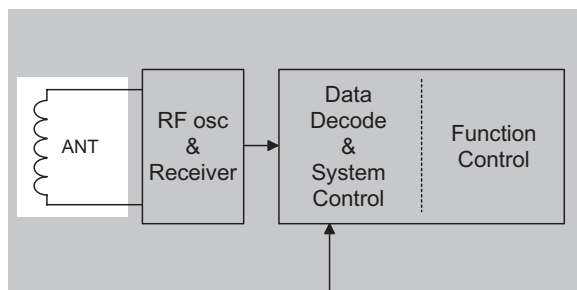

Holtek Standard MCU:
HT48XXX/HT49XXX

1-chip Solution (II)

Holtek Transponder Solution

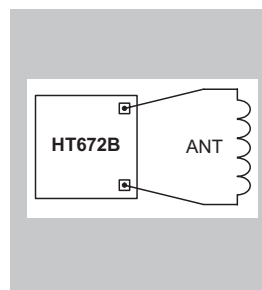

Holtek Reader Solution

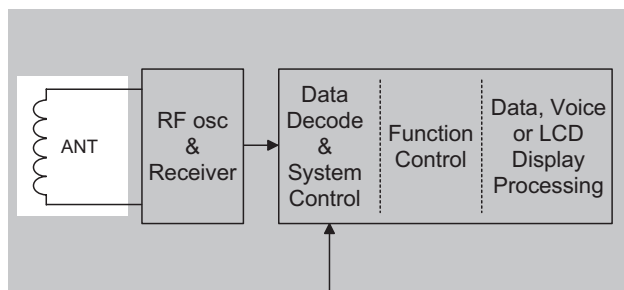

Holtek Embedded MCU:
HTG21XX/HT86XXX

Package Information

8-pin DIP (300mil) Outline Dimensions

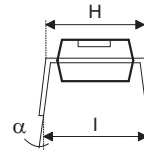
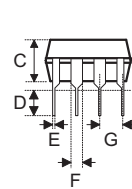
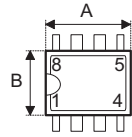

Symbol	Dimensions in mil		
	Min.	Nom.	Max.
A	355	—	375
B	240	—	260
C	125	—	135
D	125	—	145
E	16	—	20
F	50	—	70
G	—	100	—
H	295	—	315
I	335	—	375
α	0°	—	15°

Holtek Semiconductor Inc. (Headquarters)

No.3, Creation Rd. II, Science Park, Hsinchu, Taiwan
Tel: 886-3-563-1999
Fax: 886-3-563-1189
<http://www.holtek.com.tw>

Holtek Semiconductor Inc. (Taipei Sales Office)

4F-2, No. 3-2, YuanQu St., Nankang Software Park, Taipei 115, Taiwan
Tel: 886-2-2655-7070
Fax: 886-2-2655-7373
Fax: 886-2-2655-7383 (International sales hotline)

Holtek Semiconductor Inc. (Shanghai Sales Office)

7th Floor, Building 2, No.889, Yi Shan Rd., Shanghai, China 200233
Tel: 021-6485-5560
Fax: 021-6485-0313
<http://www.holtek.com.cn>

Holtek Semiconductor Inc. (Shenzhen Sales Office)

43F, SEG Plaza, Shen Nan Zhong Road, Shenzhen, China 518031
Tel: 0755-8346-5589
Fax: 0755-8346-5590
ISDN: 0755-8346-5591

Holtek Semiconductor Inc. (Beijing Sales Office)

Suite 1721, Jinyu Tower, A129 West Xuan Wu Men Street, Xicheng District, Beijing, China 100031
Tel: 010-6641-0030, 6641-7751, 6641-7752
Fax: 010-6641-0125

Holmate Semiconductor, Inc. (North America Sales Office)

46712 Fremont Blvd., Fremont, CA 94538
Tel: 510-252-9880
Fax: 510-252-9885
<http://www.holmate.com>

Copyright © 2004 by HOLTEK SEMICONDUCTOR INC.

The information appearing in this Data Sheet is believed to be accurate at the time of publication. However, Holtek assumes no responsibility arising from the use of the specifications described. The applications mentioned herein are used solely for the purpose of illustration and Holtek makes no warranty or representation that such applications will be suitable without further modification, nor recommends the use of its products for application that may present a risk to human life due to malfunction or otherwise. Holtek's products are not authorized for use as critical components in life support devices or systems. Holtek reserves the right to alter its products without prior notification. For the most up-to-date information, please visit our web site at <http://www.holtek.com.tw>.