



3D Surround Audio Processor with Dynamic Bass Boost

■ GENERAL DESCRIPTION

The **NJM2706** is the 3D surround audio processor with dynamic bass boost, regenerates rich sound field with only small two speakers.

The **NJM2706** performs NJRC original surround technology realizing natural surround sound field regarded center orientation and NJRC original dynamic bass boost technology provides graceful bass sound with low distortion.

It is suitable for mini-component, CD radio-cassette, TV, speaker system and others.

■ PACKAGE OUTLINE



NJM2706VE1

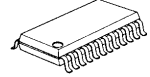

NJM2706M

■ FEATURES

- Operating Voltage +4.7V to +13.0V
- Wide Dynamic Range 3.1Vrms typ.
- Low Output Noise 8.9μVrms typ.
- "eala" 3D Surround Function (Stereo only)
- Dynamic Bass Boost Function
- High Frequency Compensation (f=10kHz, GV=+3dB)
- Variable Surround Effect by external resistor
- Internal Mode Control Switch
- Bipolar Technology
- Package Outline DMP24, SSOP24

■ BLOCK DIAGRAM

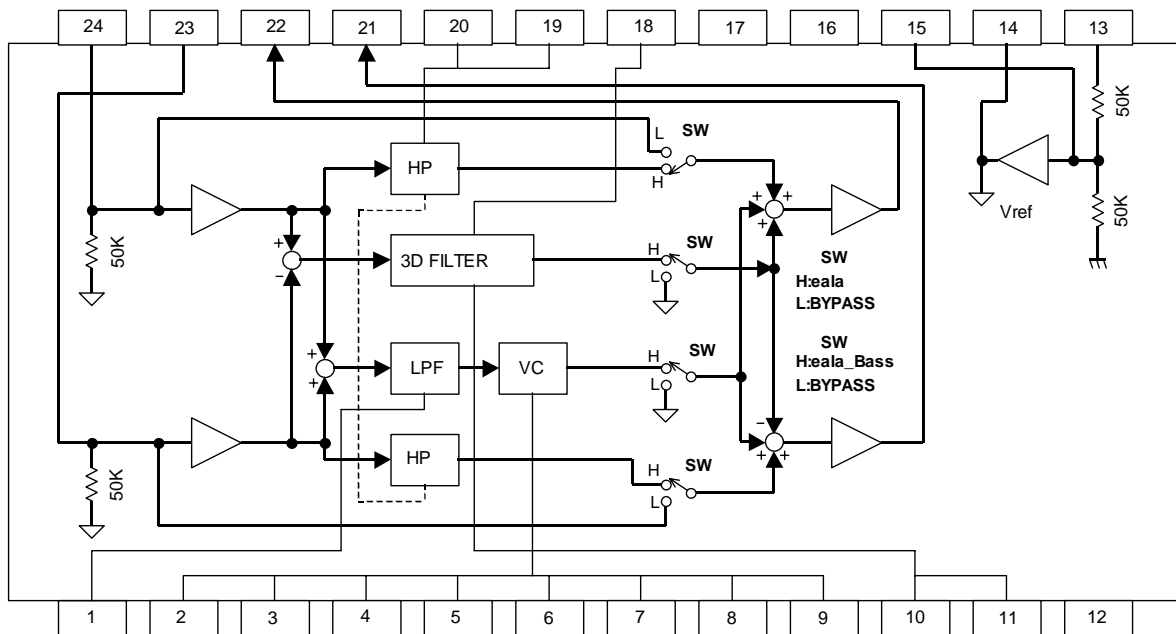

■ PIN CONFIGURATION

DMP24, SSOP24 (Top View)

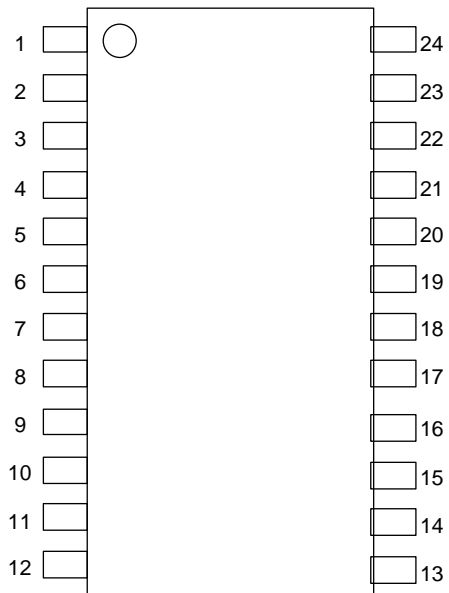

- | | |
|---------------|-------------|
| 1. LPF | 13. V+ |
| 2. MIN | 14. VREFOUT |
| 3. MOUT | 15. VREFIN |
| 4. Ca | 16. SW1 |
| 5. Cr | 17. SW2 |
| 6. BASSFIL1 | 18. ealaFIL |
| 7. BASSFIL2 | 19. HFFILL |
| 8. BASSVRIN | 20. HFFILR |
| 9. BASSVROUT | 21. ROUT |
| 10. ealaVRIN | 22. LOUT |
| 11. ealaVROUT | 23. RIN |
| 12. GND | 24. LIN |

■ABSOLUTE MAXIMUM RATING (Ta=25°C)

PARAMETER	SYMBOL	RATINGS	UNIT
Supply Voltage	V ⁺	15	V
Power Dissipation	P _D	(DMP24) 700 (SSOP24) 600	mW
Operating Temperature Range	T _{opr}	-40 to +85	°C
Storage Temperature Range	T _{stg}	-40 to +125	°C

■OPERATING VOLTAGE

PARAMETER	SYMBOL	TEST CONDITION	MIN	TYP	MAX	UNIT
Operating Voltage	V ⁺	-	4.7	12.0	13.0	V

■ELECTRICAL CHARACTERISTICS (Ta=25°C, V+=12V unless otherwise specified)

PARAMETER	SYMBOL	TEST CONDITION	TEST CONDITION						MIN	TYP	MAX	UNIT
			INPUT		OUT PUT	MODE	eala VR	Bass VR				
			L	R								
Operating Current	I _{cc}	No Signal	0	0	-	Bypass	-	-	-	15.4	23.0	mA
			0	0	-	Bass	MAX	-	-	15.4	23.0	
Reference Voltage	V _{ref}	No Signal	0	0	-	-	-	-	5.8	6.0	6.2	V

●AC CHARACTERISTICS (Ta=25°C, V+=12V, V_{IN}=-20dBV(100mVrms) unless otherwise specified)

PARAMETER	SYMBOL	TEST CONDITION	TEST CONDITION						MIN	TYP	MAX	UNIT
			INPUT		OUT PUT	MODE	eala VR	Bass VR				
			L	R								
Maximum Input Voltage	V _{IM}	f=1kHz THD=3%	V _{IN}	-	L	Bypass	-	-	10.0 (3.2)	12.0 (4.0)	-	dBV (Vrms)
		f=100Hz THD=3%	V _{IN}	V _{IN}	*1	Bass	MAX	-	-	6.0 (2.0)	-	
		f=1kHz THD=3%	V _{IN}	-	L	eala	-	MAX	-	7.9 (2.5)	-	
		f=10kHz THD=3%	V _{IN}	-	L	eala Bass	MAX	MAX	7.8 (2.5)	9.8 (3.1)	-	
		f=100Hz THD=3%	V _{IN}	-	L	eala Bass	MAX	MAX	3.4 (1.5)	5.4 (1.9)	-	
Output Noise	V _{NO}	Rg=0Ω A-Weighted	0	0	L R	Bypass	-	-	-	-110 (3)	-100 (10)	dBV (μVrms)
		Rg=0Ω A-Weighted	0	0	L R	Bass	MAX	-	-	-98 (13)	-	
		Rg=0Ω A-Weighted	0	0	L R	eala	-	MAX	-	-100 (10)	-	
		Rg=0Ω A-Weighted	0	0	L R	eala Bass	MAX	MAX	-	-97 (14)	-92 (25)	
Total Harmonic Distortion	THD	f=1kHz	V _{IN}	-	L R	Bypass	-	-	-	0.005	0.01	%
		f=100Hz	V _{IN} V _{IN}	V _{IN} V _{IN}	L R	Bass	MAX	-	-	0.05	-	
		f=1kHz	V _{IN}	-	L R	eala	-	MAX	-	0.05	-	
		f=1kHz	V _{IN}	-	L R	eala Bass	MAX	MAX	-	0.05	0.5	

*1:BASSVR2OUT

●AC CHARACTERISTICS ($T_a=25^{\circ}\text{C}$, $V^+=12\text{V}$, $V_{IN}=-20\text{dBV}(100\text{mVrms})$ unless otherwise specified)

PARAMETER	SYMBOL	TEST CONDITION							MIN	TYP	MAX	UNIT
		INPUT		OUT PUT	MODE	eala VR	Bass VR					
		L	R									
Bypass Gain	G_{VBYP}	f=1kHz	V_{IN} -	- V_{IN}	L R	Bypass	-	-	-1.0	0.0	1.0	dB
eala Gain	G_{eala}	f=100Hz	V_{IN} V_{IN}	V_{IN} V_{IN}	L R	Bass	MAX	-	4.4	6.4	8.4	dB
		f=100Hz	V_{IN} V_{IN}	V_{IN} V_{IN}	L R	Bass	MIN	-	-2.0	0.0	2.0	
		f=1kHz	V_{IN} -	- V_{IN}	L R	eala	-	MAX	2.1	4.1	6.1	
		f=1kHz	V_{IN} -	- V_{IN}	L R	eala	-	MIN	-2.0	0.0	2.0	
		f=100Hz	V_{IN} -	- V_{IN}	L R	eala Bass	MAX	MAX	5.9	7.9	9.9	
		f=10kHz	V_{IN} -	- V_{IN}	L R	eala Bass	MAX	MAX	0.0	2.0	4.0	

●CONTROL CHARACTERISTICS ($T_a=25^{\circ}\text{C}$, $V^+=12\text{V}$, unless otherwise specified)

PARAMETER	SYMBOL	TEST CONDITION	MIN	TYP	MAX	UNIT
MODE Select Control Voltage	V_{MODE}	V_{IN} =High Level	2.0	-	V^+	V
		V_{IN} =Low Level	0.0	-	0.7	

■SWITCH FUNCTION

MODE	SW2	SW1	NOTES
Bypass	L	L	Input Through
eala	L	H	3D Surround mode
Bass	H	L	Bass Enhanced mode
eala Bass	H	H	3D Surround and Bass Enhanced mode

■ TERMINAL DESCRIPTION

No.	SYMBOL	FUNCTION	EQUIVALENT CIRCUIT	VOLTAGE
1	LPF	Capacitor terminal for LPF		V+/2
2	MIN	Monaural Amplifier Input		V+/2
3	MOUT	Monaural Amplifier Output		V+/2
4 5	Ca Cr	Capacitor Terminal for Attack Time Constant Capacitor Terminal for Release Time Constant		0V
6	BASSFIL1	BASS Filter Terminal 1		0V

■ TERMINAL DESCRIPTION

No.	SYMBOL	FUNCTION	EQUIVALENT CIRCUIT	VOLTAGE
7 21 22	BASSFIL2 ROUT LOUT	BASS Filter Terminal 2 Rch Output Lch Output		V+/2
8	BASSVRIN	BASS Effect Adjust Terminal		V+/2
9	BASSVROUT	BASS Effect Adjust Terminal		V+/2
10	ealaVRIN	eala Effect Adjust Terminal		V+/2
11	ealaVROUT	eala Effect Adjust Terminal		V+/2

■ TERMINAL DESCRIPTION

No.	SYMBOL	FUNCTION	EQUIVALENT CIRCUIT	VOLTAGE
12	GND	GND Terminal	—————	0V
13	V+	Power Supply Terminal	—————	V+
14	VREFOUT	Reference Voltage Output		V+/2
15	VREFIN	Reference Voltage Input		V+/2
16 17	SW1 SW2	Mode Switch 1 Mode Switch 2		0V

■ TERMINAL DESCRIPTION

No.	SYMBOL	FUNCTION	EQUIVALENT CIRCUIT	VOLTAGE
18	ealaFIL	eala Filter Terminal		V+/2
19 20	HFFILL HFFILR	High Frequency Filter for Lch High Frequency Filter for Rch		V+/2
23 24	RIN LIN	Rch Input Lch Input		V+/2

APPLICATION CIRCUIT

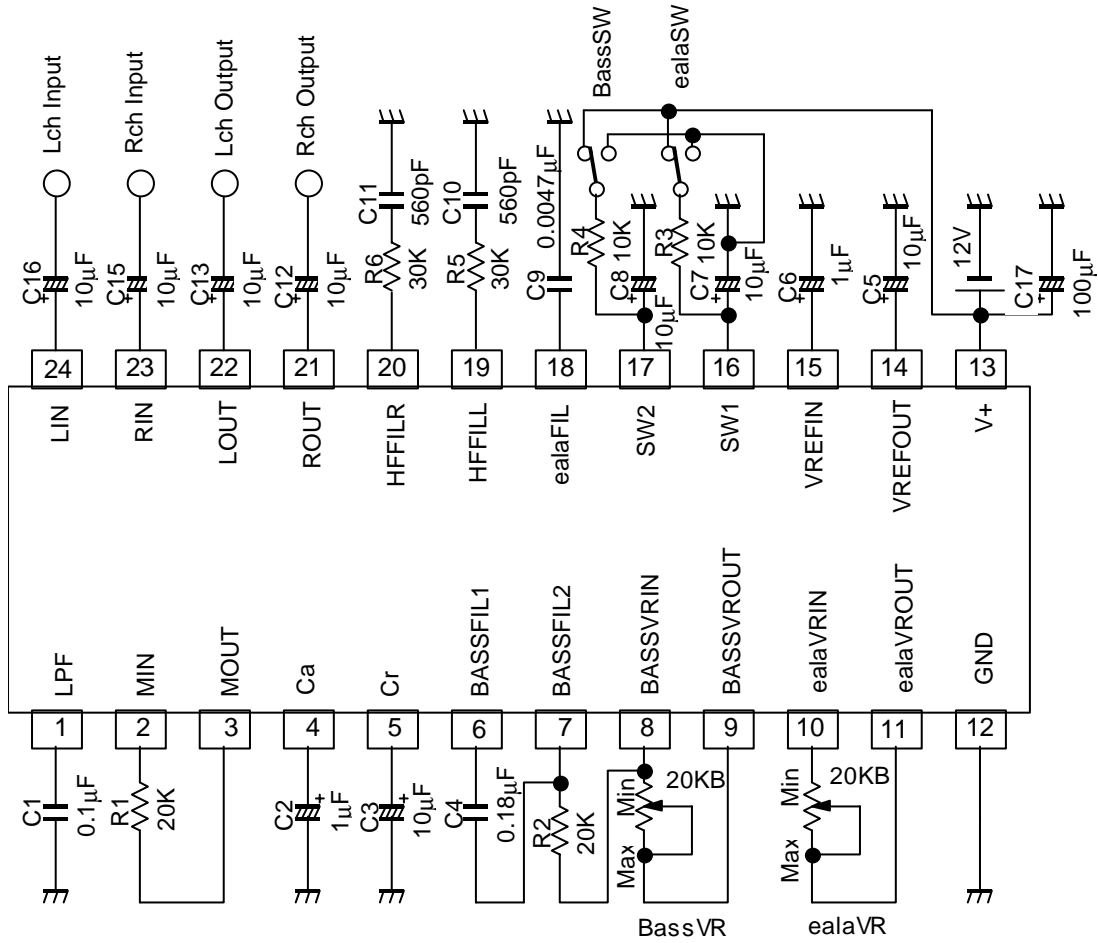

APPLICATION NOTE

1. Fine-Tuning the ealaBASS

The NJM2706 has quite sophisticated NJRC's original dynamic bass-boost technology. Both of the level and the frequency for bass-boost moves automatically corresponding to the input signal level. This dynamic filtering action prevents the signals over boosted, and provides less distortion and wide dynamic range bass-boost processing.

In addition, if you want to fine-tune the bass-boost effect for your system, you can modify the bass-boost effect by changing the external parts value as described below.

1-1. Modify the Boost Center Frequency

This plot shows the frequency response for NJM2706 ealaBASS.

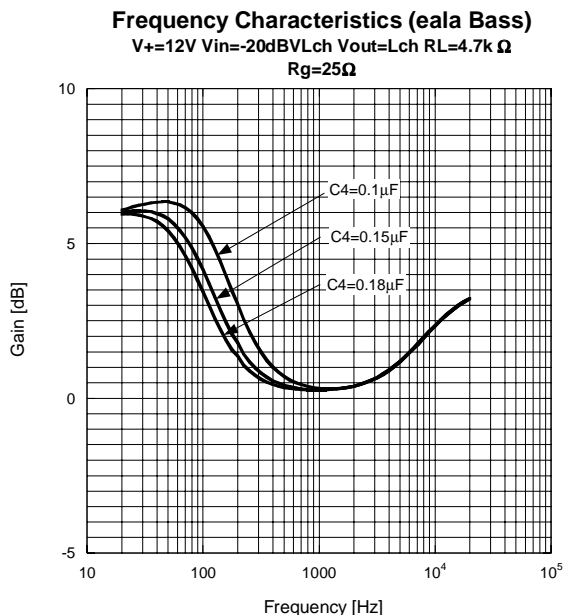

The Boost Center Frequency can be adjusted by changing the value for the external capacitor, C4. If your speaker system has more than 100Hz of f_0 (= Lower Frequency Response Range), or, if you would like to get more powerful bass-boost effect than the typical settings shown on the page 9, increasing the Boost Center Frequency higher could be a good idea. We strongly recommend you to determine the actual capacitance value by testing and examinations on your actual application.

1-2. Modification for the LPF Cut-off Frequency f_{CL}

This picture shows the equivalent circuit for NJM2706's LPF.

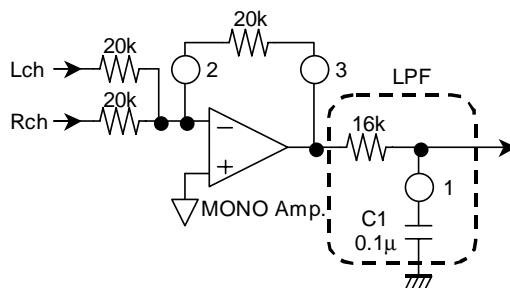

The LPF Cut-off Frequency f_{CL} is given by the following equation:

$$f_{CL} = \frac{1}{2\pi CR} = \frac{1}{2\pi C1 \times 16k}$$

Set the f_{CL} as same as the Boost Center Frequency, which is determined as above (The Boost Center Frequency = the frequency of which the gain is +3dB). In the typical application circuit shown on the page 9, the LPF Cut-off Frequency f_{CL} is set to 100Hz.

1-3. Adjusting the Summing Level for ealaBASS effect to L/R Output Signal

Changing the resistance value connected between the terminal 8 and 9 can modify the Summing Level for the ealaBASS effect to the L/R Output Signal.

2. Adjusting the High Frequency Compensation Filter

The NJM2706 has High Frequency Compensation Filter, which can produce well balance between boosted-bass frequency range and treble frequency range. This picture shows the equivalent circuit for the High Frequency Compensation Filter.

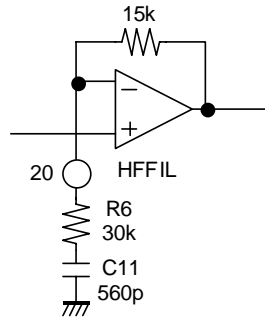

The Cut-off Frequency f_{CH} and the Voltage Gain G_{VH} are defined as below:

$$f_{CH} = \frac{1}{2\pi CR} = \frac{1}{2\pi \times C11 \times R6} \quad G_{VH} = 20\log \frac{R6+15k}{R6}$$

In the typical application circuit shown on the page 9, the High Frequency Compensation Filter Cut-off Frequency f_{CH} is set to 10kHz and Voltage Gain G_{VH} is set to 3.5dB.

TYPICAL CHARACTERISTICS

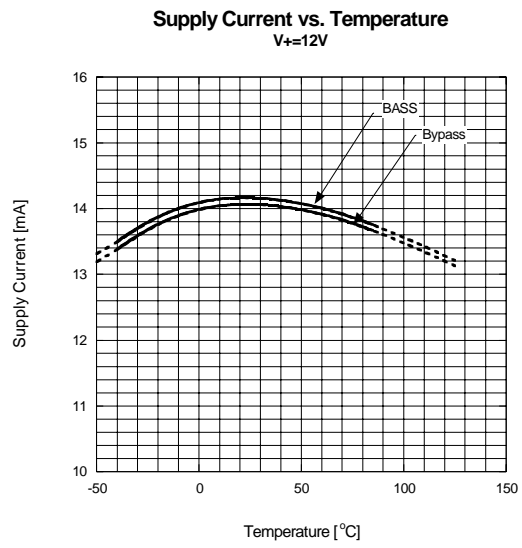
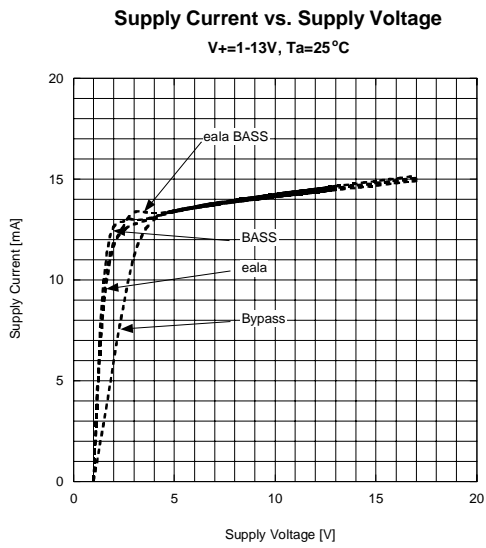

Maximum Input Voltage vs. Supply Voltage (Bypass)
 $V_{in}=Lch, V_{out}=Lch, f=1kHz, R_L=4.7k \Omega,$
 $R_g=25 \Omega, T_a=25^\circ C$

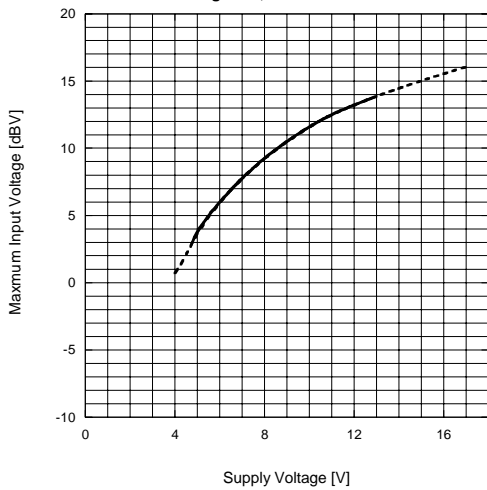

Maximum Input Voltage vs. Supply Voltage (BASS)
 $V_{in}=Lch+Rch, V_{out}=BASSVROUT, f=100Hz, R_L=4.7k \Omega,$
 $R_g=25 \Omega, T_a=25^\circ C$

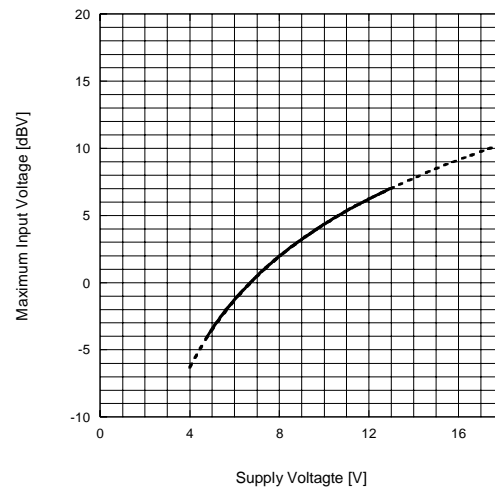

Maximum Input Voltage vs. Supply Voltage (eala)
 $V_{in}=Lch, V_{out}=Lch, f=1kHz, R_L=4.7k \Omega,$
 $R_g=25 \Omega, T_a=25^\circ C$

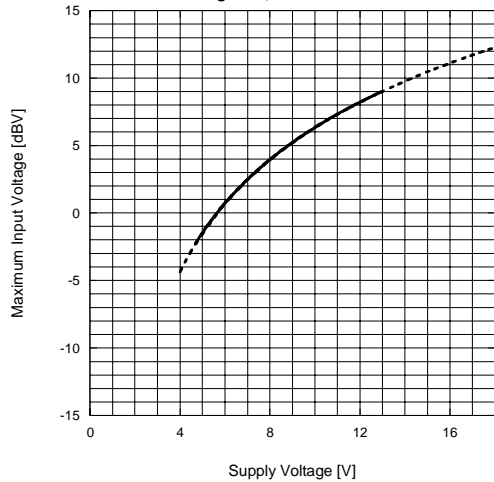

Maximum Input Voltage (eala BASS)
 $V_{in}=Lch, V_{out}=Lch, f=10kHz, R_L=4.7k \Omega,$
 $R_g=25 \Omega, T_a=25^\circ C$

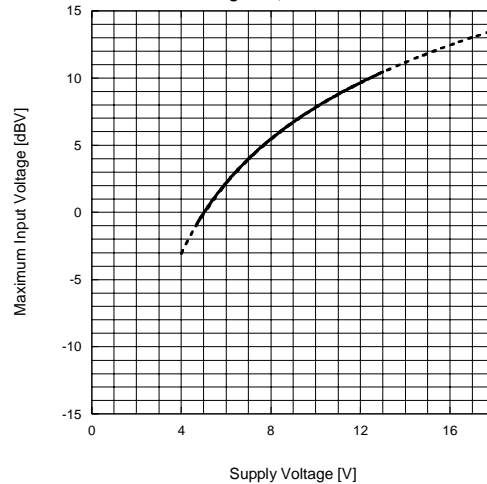

■ TYPICAL CHARACTERISTICS

Maximum Input Voltage vs. Supply Voltage (eala BASS)
 $V_{in}=Lch+Rch, V_{out}=Lch, f=100Hz, R_L=4.7k \Omega,$
 $R_g=25\Omega, T_a=25^\circ C$

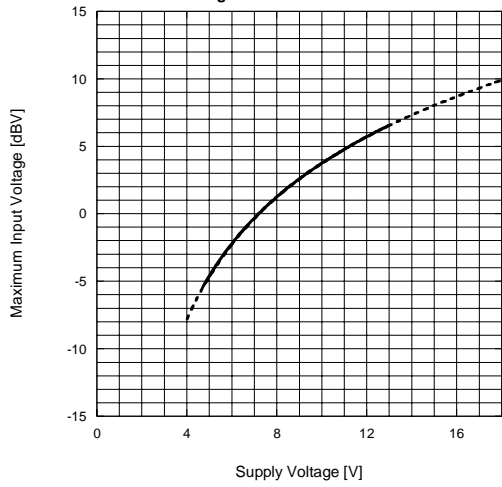

Output Noise vs. Temperature
 $V_+=12V, V_{in}=GND, V_{out}=Lch$

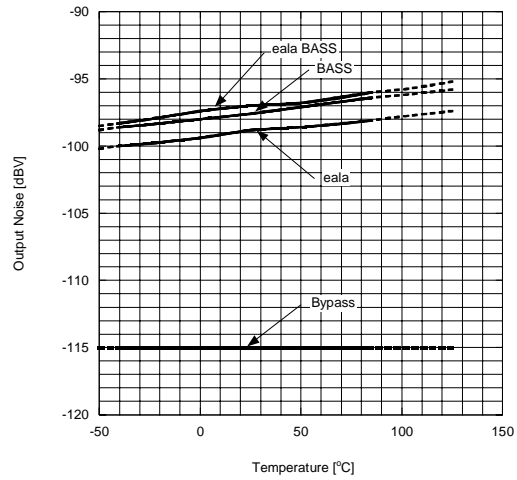

THD+N vs. Input Voltage (Bypass)
 $V_+=12V, V_{in}=Lch, V_{out}=Lch, f=100Hz, R_L=4.7k \Omega,$
 $R_g=25\Omega, BW=10-80kHz$

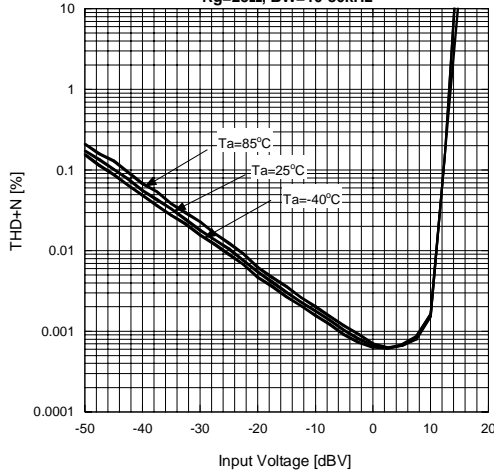

THD+N vs. Input Voltage (Bypass)
 $V_+=12V, V_{in}=Lch, V_{out}=Lch, f=1kHz, R_L=4.7k \Omega,$
 $R_g=25\Omega, BW=10-80kHz$

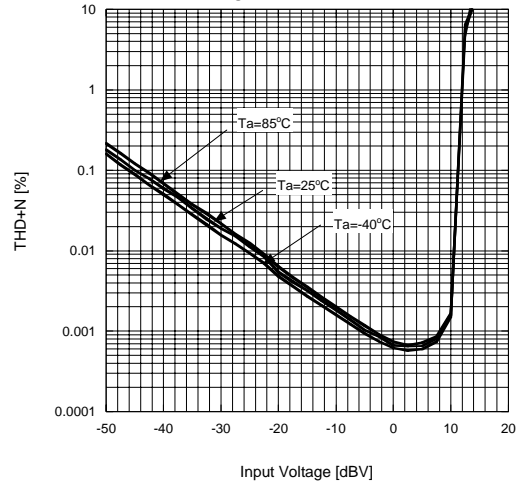

THD+N vs. Input Voltage (Bypass)
 $V_+=12V, V_{in}=Lch, V_{out}=Lch, f=10kHz, R_L=4.7k \Omega,$
 $R_g=25\Omega, BW=10-80kHz$

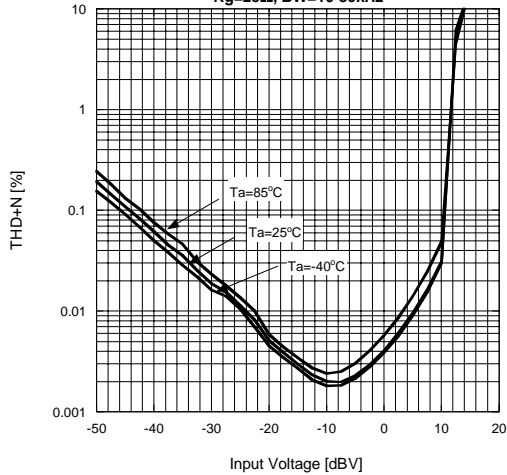

THD+N vs. Input Voltage (eala)
 $V_+=12V, V_{in}=Lch, V_{out}=Lch, f=1kHz, R_L=4.7k \Omega,$
 $R_g=25\Omega, BW=10-80kHz$

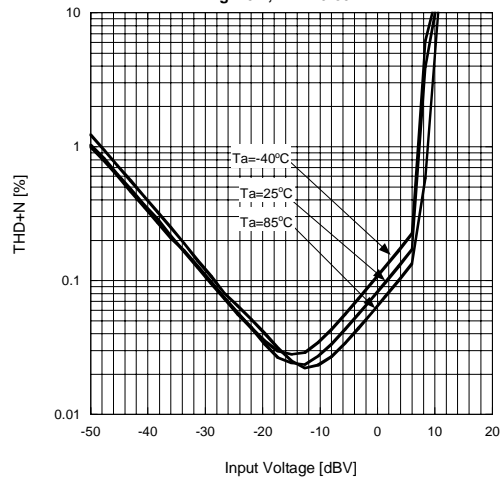

TYPICAL CHARACTERISTICS

THD+N vs. Input Voltage (eala BASS)

V+=12V, Vin=Lch, Vout=Lch, f=100Hz, RL=4.7k Ω,
Rg=25Ω, BW=10-80kHz

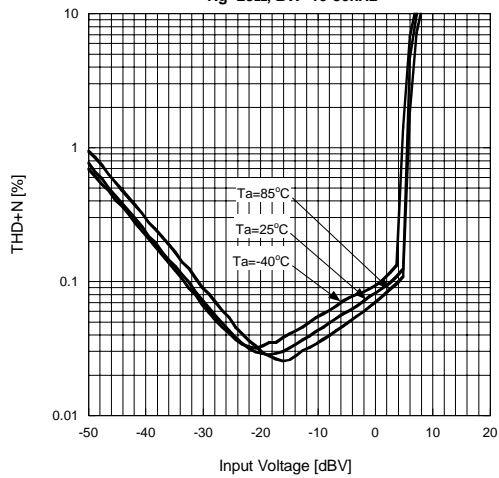

THD+N vs. Input Voltage (eala BASS)

V+=12V, Vin=Lch, Vout=Lch, f=1kHz, RL=4.7k Ω,
Rg=25Ω, BW=10-80kHz

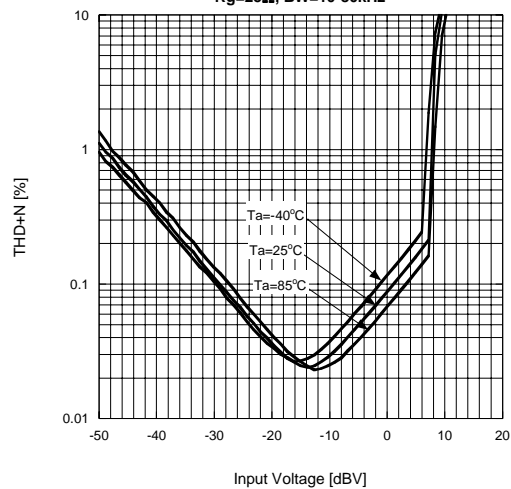

THD+N vs. Input Voltage (eala BASS)

V+=12V, Vin=Lch, Vout=Lch, f=20kHz, RL=4.7k Ω,
Rg=25Ω, BW=10-80kHz

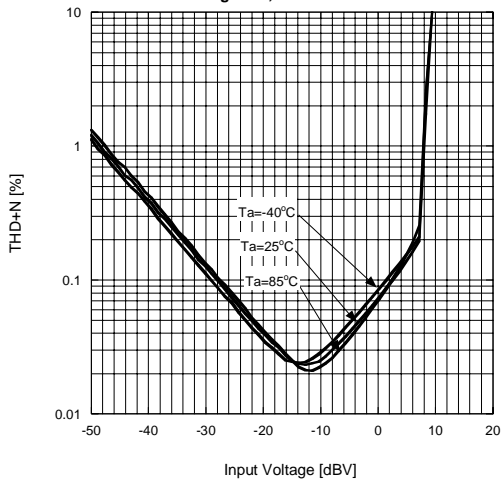

Gain vs. Frequency (Bypass)

V+=12V, Vin=20dBV Lch, Vout=Lch, RL=4.7k Ω,
Rg=25Ω

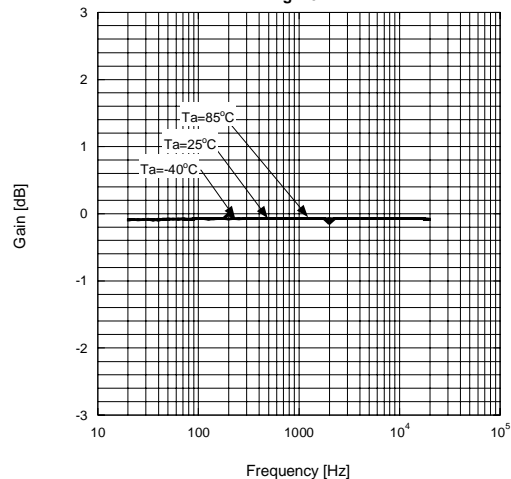

Gain vs. Frequency (BASS)

V+=12V, Vin=20dBV Lch+Rch, Vout=Lch, RL=4.7k Ω,
Rg=25Ω

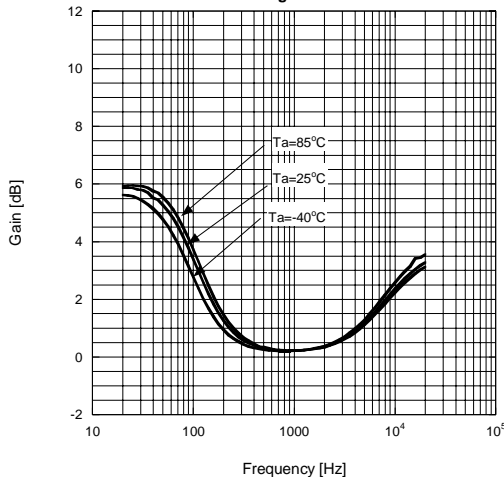

Gain vs. Frequency (eala)

V+=12V, Vin=20dBV Lch, Vout=Lch, RL=4.7k Ω,
Rg=25Ω

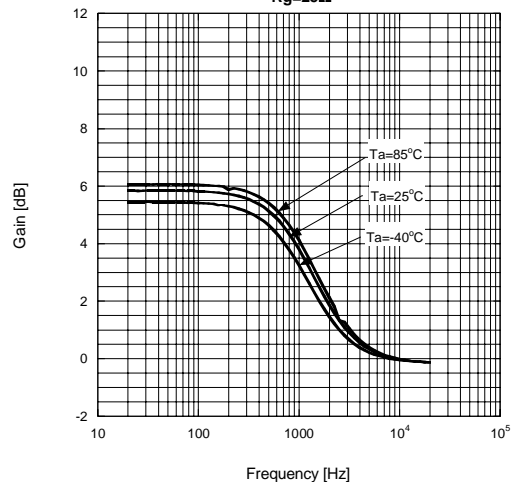

■ TYPICAL CHARACTERISTICS

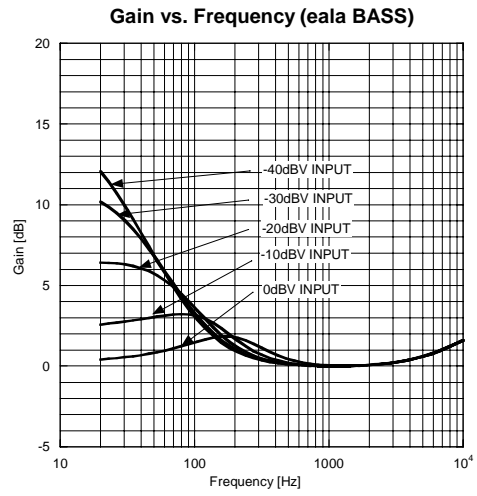
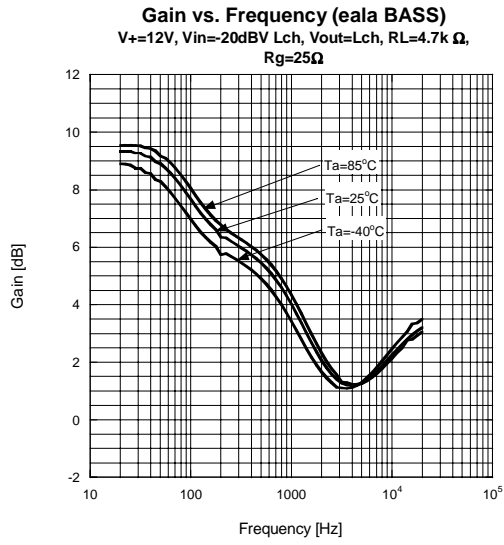

[CAUTION]
The specifications on this databook are only given for information, without any guarantee as regards either mistakes or omissions. The application circuits in this databook are described only to show representative usages of the product and not intended for the guarantee or permission of any right including the industrial rights.