

## Headphone Amplifier for Portable Audio

### ■ GENERAL DESCRIPTION

The **NJM2776** is a low voltage headphone amplifier for portable audio applications.

The **NJM2776** operates directly for one battery supply with independent power supply terminals ( $V^{+1}$  and  $V^{+2}$ ).

Also it provides shock-noise less standby mode.

The **NJM2776** is suitable for portable MD, portable CD and others.

### ■ PACKAGE OUTLINE



**NJM2776RB2**

### ■ FEATURES

- Operating Voltage  $V^{+1}$ (from step-up converter) = 1.8 to 4.5V (however,  $V^{+1} > V^{+2}$ )
  - Low Operating Current  $V^{+2}$ (from battery) = 0.9 to 4.5V (however,  $V^{+1} > V^{+2}$ )
  - Supply Current in Standby mode  $I_{CC4}(V^{+1} \text{ side})=200\mu\text{A typ. (} V^{+1}=2.3\text{V, } V^{+2}=1.2\text{V, No signal)}$
  - Output Power Exceeds  $I_{CC3}(V^{+2} \text{ side})=350\mu\text{A typ. (} V^{+1}=2.3\text{V, } V^{+2}=1.2\text{V, No signal)}$
  - Shock-noise less Standby mode  $I_{CC2}(V^{+1} \text{ side})=25\mu\text{A typ. (} V^{+1}=2.3\text{V, } V^{+2}=1.2\text{V)}$
  - Bipolar Technology  $I_{CC1}(V^{+2} \text{ side})= 6\mu\text{A typ. (} V^{+1}=2.3\text{V, } V^{+2}=1.2\text{V)}$
  - Package Outline  $P_O=8.5\text{mW typ. (} R_L=16\Omega, \text{THD}=10\%)$
- TVSP10

### ■ PIN CONFIGURATION AND BLOCK DIAGRAM

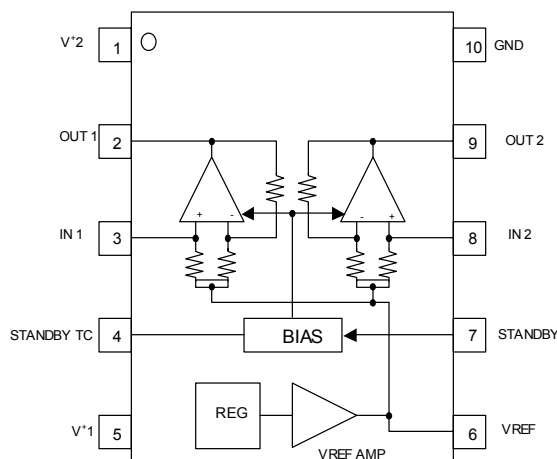

1.  $V^{+2}$
2. OUT1
3. IN1
4. STANDBY\_TC
5.  $V^{+1}$
6. VREF
7. STANDBY
8. IN2
9. OUT2
10. GND

# NJM2776

## ■ ABSOLUTE MAXIMUM RATINGS (Ta=25°C)

PARAMETER	SYMBOL	RATINGS	UNIT
Supply Voltage	V <sup>+</sup>	5	V
Power Dissipation	P <sub>D</sub>	320 <sup>(note)</sup>	mW
Operating Temperature range	T <sub>opr</sub>	-20 to +75	°C
Storage Temperature Range	T <sub>stg</sub>	-40 to +125	°C

## ■ RECOMMENDED OPERATING CONDITIONS

PARAMETER	SYMBOL	TEST CONDITION	MIN.	TYP.	MAX.	UNIT
Operating Voltage Range	V <sup>+1</sup>	-	1.8	2.3	4.5	V
	V <sup>+2</sup>	-	0.9	1.2	4.5	

## ■ ELECTRICAL CHARACTERISTICS (Ta=25°C, V<sup>+1</sup>=2.3V, V<sup>+2</sup>=1.2V, V<sub>IN</sub>=-30dBV (31.6mVrms), f=1kHz, R<sub>L</sub>=16Ω, Active mode, unless otherwise specified)

### ● Power Supply

PARAMETER	SYMBOL	TEST CONDITION	pin	MIN.	TYP.	MAX.	UNIT
Operating Current	I <sub>CC0</sub>	V <sup>+1</sup> =0V	V <sup>+2</sup>	-	-	1.0	μA
	I <sub>CC1</sub>	Standby mode	V <sup>+2</sup>	-	6.0	10.0	
	I <sub>CC2</sub>		V <sup>+1</sup>	-	25	35	
	I <sub>CC3</sub>	No signal	V <sup>+2</sup>	-	350	750	mA
	I <sub>CC4</sub>		V <sup>+1</sup>	-	200	400	
		I <sub>CC5</sub>	P <sub>O</sub> =0.1mW+0.1mW	V <sup>+2</sup>	-	2.5	-
	I <sub>CC6</sub>	V <sup>+1</sup>		-	200	-	
Reference Voltage	V <sub>REF</sub>	No signal		0.50	0.60	0.65	V

### ● Amplifier

PARAMETER	SYMBOL	TEST CONDITION	MIN.	TYP.	MAX.	UNIT
Closed loop Gain	G <sub>V</sub>		10.0	11.5	12.5	dB
Output Power	P <sub>O</sub>	THD=10%	5.0	8.5	-	mW
Total Harmonic Distortion	THD	P <sub>O</sub> =1mW	-	0.20	0.50	%
Output Noise Voltage	V <sub>NO</sub>	A-Weighted	-	-100 (10.0)	-96 (15.8)	dBV (μV)
Channel Separation	CS		44	55	-	dB
Mute Level	MUTE	Standby mode 1kHz Band Pass	-	-100	-80	dB
Supply Voltage Rejection Ratio	PSRR1	V <sup>+1</sup> =1.8V + 0.1Vrms V <sup>+2</sup> =0.9V	46	52	-	dB
	PSRR2	V <sup>+1</sup> =1.8V V <sup>+2</sup> =0.9V + 0.1Vrms	70	77	-	

### ● Mode Control

PARAMETER	SYMBOL	TEST CONDITION	MIN.	TYP.	MAX.	UNIT
High Level Input Voltage	V <sub>IH</sub>	V <sub>IN</sub> =High Level	1.2	-	V <sup>+1</sup>	V
Low Level Input Voltage	V <sub>IL</sub>	V <sub>IN</sub> =Low Level	0.0	-	0.3	

## ■ MODE SWITCH FUNCTION

### ● STANDBY (7PIN)

PARAMETER	CONTROL SIGNAL	STATUS
Standby	L, open	IC is non-active.
Active	H	IC is active.

## ■ TERMINAL DESCRIPTION

PIN No.	SYMBOL	EQUIVALENT CIRCUIT	VOLTAGE	NOTE
2,9	OUT1, OUT2		0.6V	
3,8	IN1, IN2		0.6V	
4	STANDBY_TC		1.2V	
6	VREF		0.6V	

# NJM2776

PIN No.	SYMBOL	EQUIVALENT CIRCUIT	VOLTAGE	NOTE
7	STANDBY		-	

## APPLICATION CIRCUIT

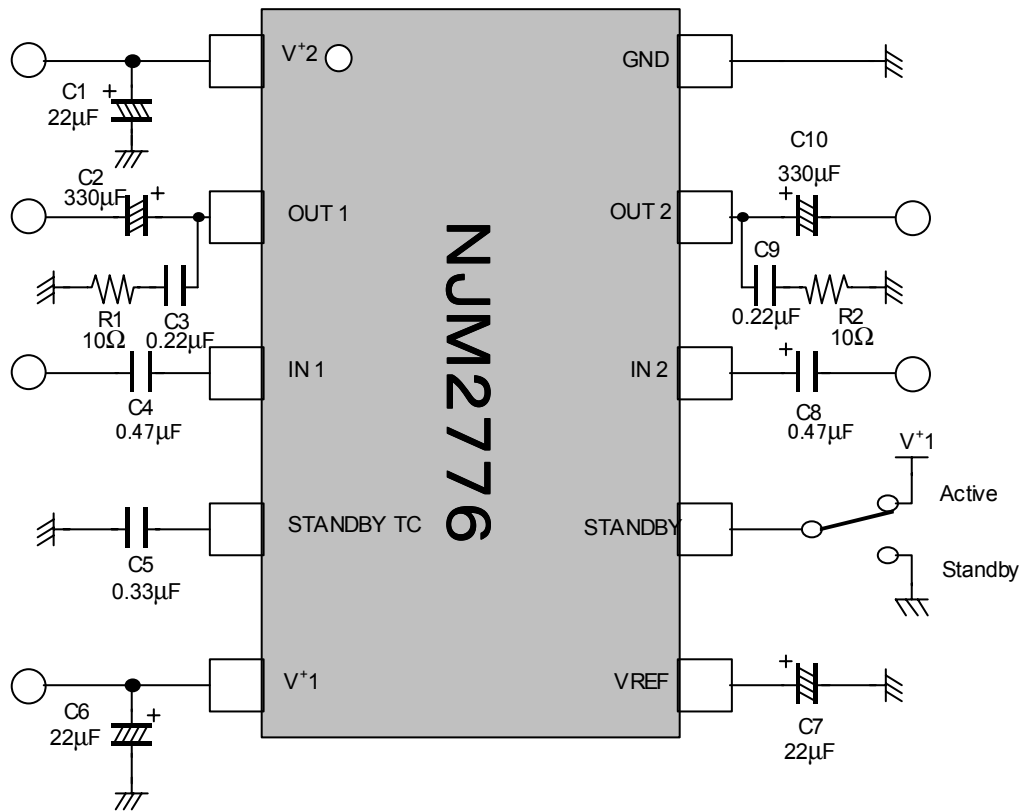

Note) Recommended the capacitors — C1, C3, C6 and C9 — are featuring higher frequency efficiency to prevent the oscillation.

## ■ APPLICATION NOTE

### 1. Procedure for Supplying Power

Supply the power to first  $V^{+2}$ (Battery side) and then  $V^{+1}$ (Step-up Converter side).

### 2. Input Dynamic Voltage Range

The reference voltage is fixed at 0.6V. Therefore input dynamic voltage range is not proportion to the power supply voltage.

The input signal over dynamic range makes distortion. For prevent the distortion, adjust the maximum input signal level.

### 3. Charge Sequence

Pop noise may not be happened with mode switch operation once output voltage becomes reference voltage. The "Charge Sequence" may shorter the time for power up initialization.

Charge Sequence: To set mode switch from standby to active during power up initialization, activate rapid charge circuit for stabilizing the output voltage.

## ■ TYPICAL CHARACTERISTICS

### Operating Current vs. Operating Voltage

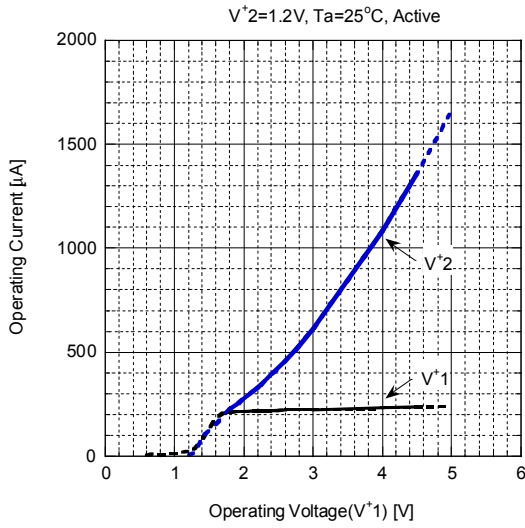

### Operating Current vs. Operating Voltage

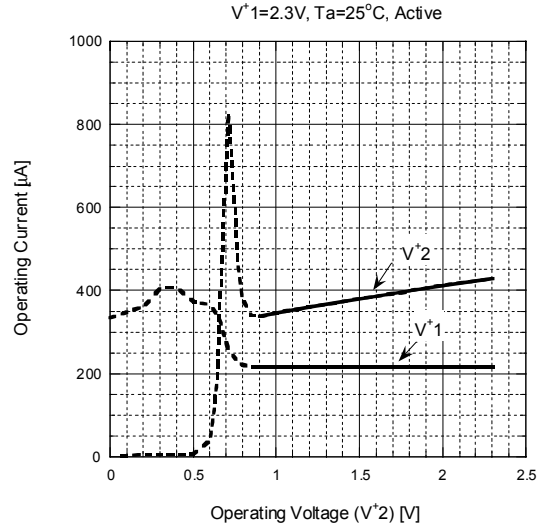

### Operating Current vs. Operating Voltage

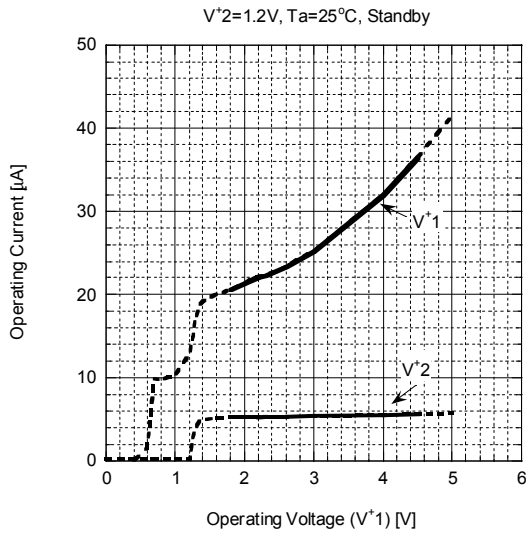

### Operating Current vs. Operating Voltage

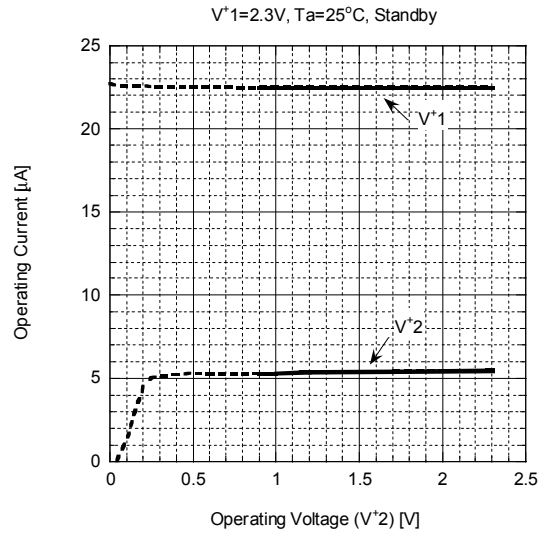

### Operating Current vs. Temperature

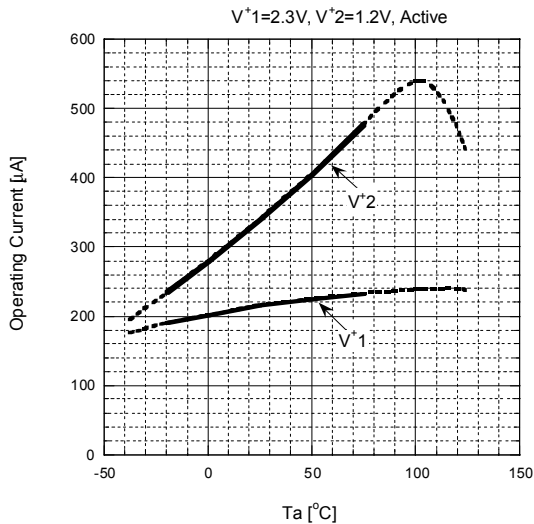

### Operating Current vs. Temperature

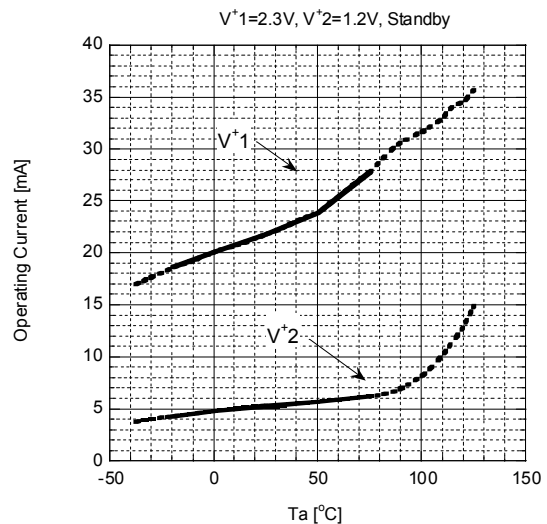

## ■ TYPICAL CHARACTERISTICS

Reference Voltage vs. Operating Voltage

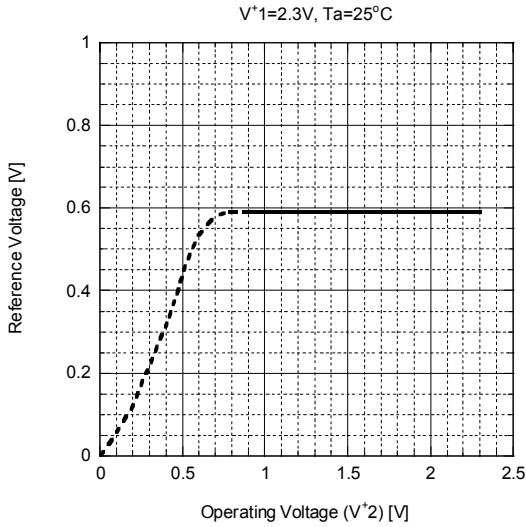

Reference Voltage vs. Temperature

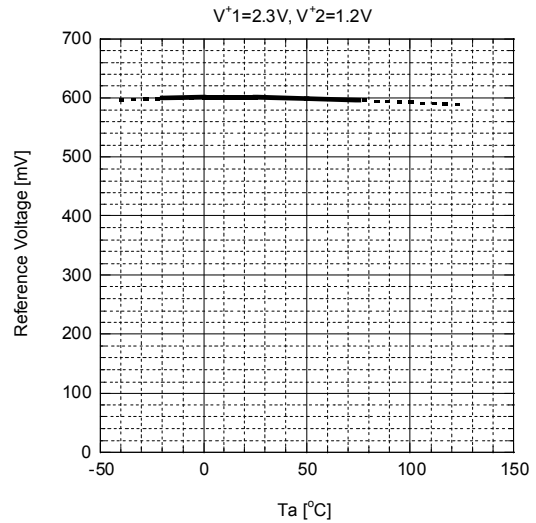

Total Harmonic Distortion vs. Output Power

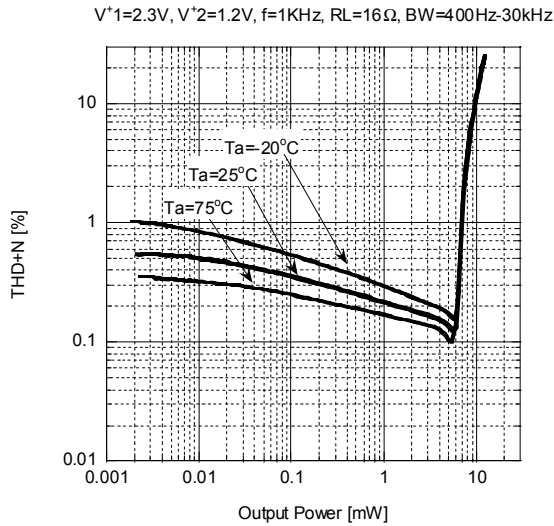

Total Harmonic Distortion vs. Output Power

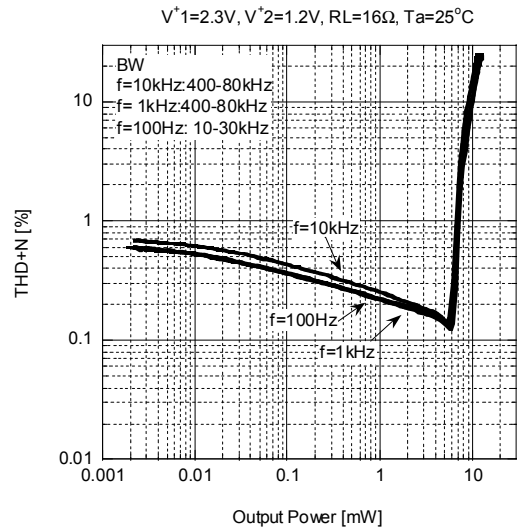

Output Power vs. Operating Voltage

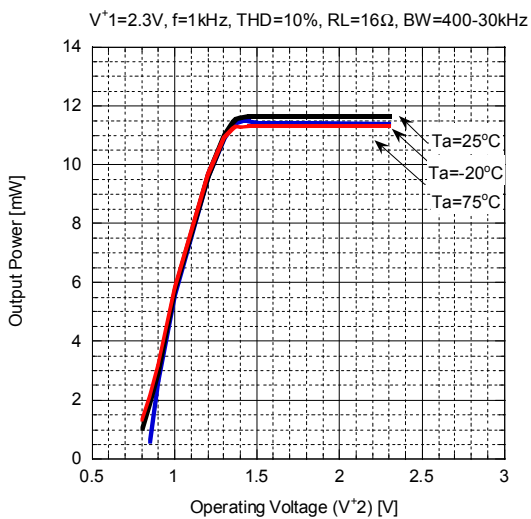

Power Dissipation vs. Output Power

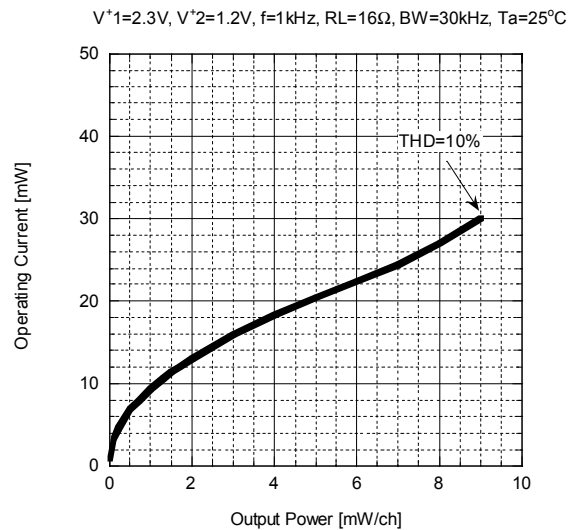



## ■ TYPICAL CHARACTERISTICS

### Output Noise Voltage vs. Temperature

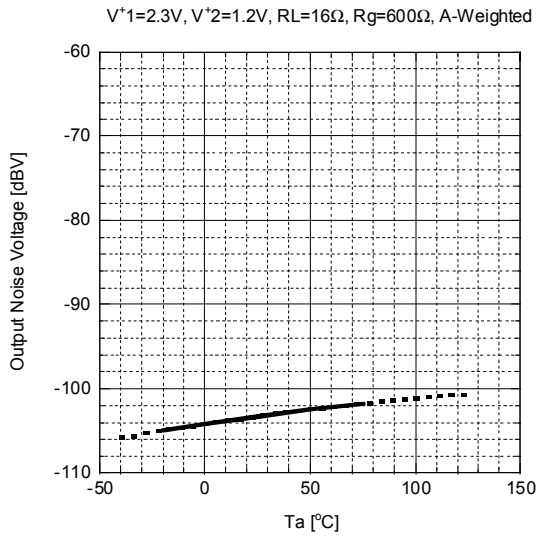

### Channel Separation vs. Frequency

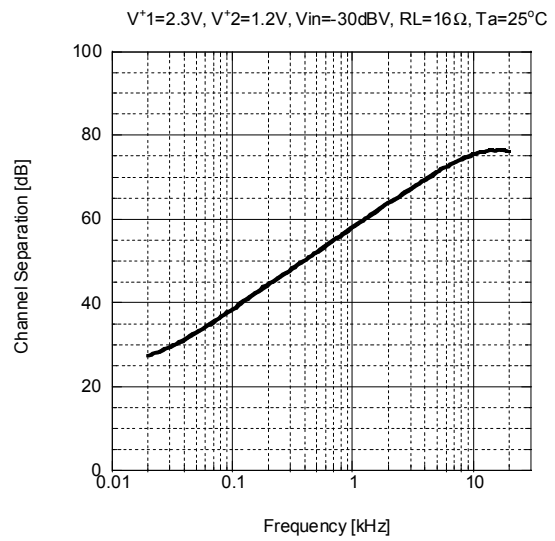

### Mute Level vs. Frequency

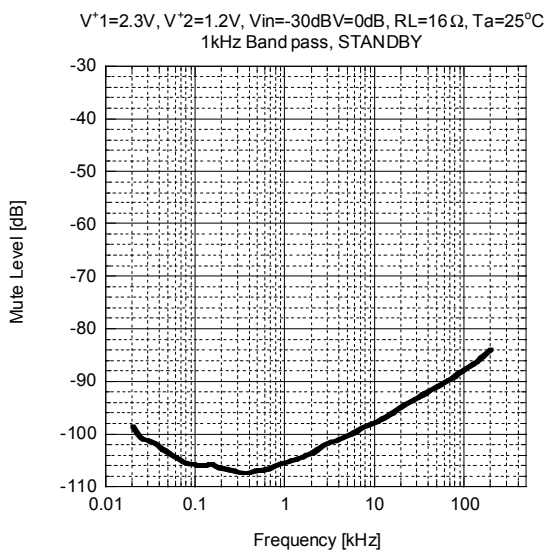

### Mute Level vs. Temperature

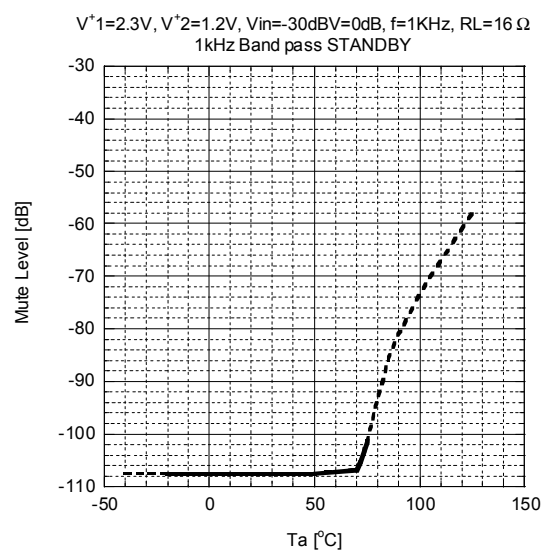

### PSRR vs. frequency ( $V^+1$ )

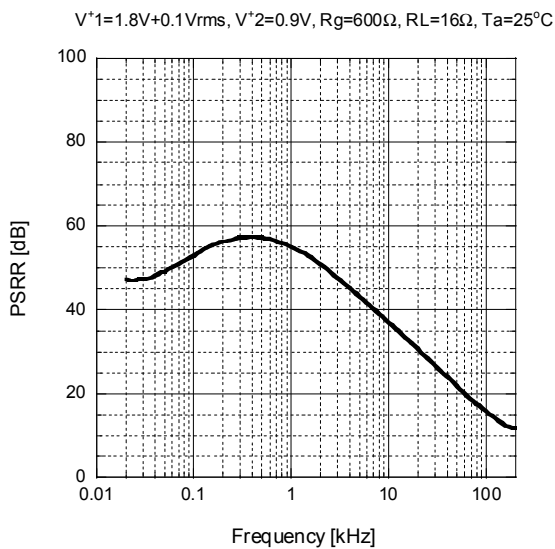

### PSRR vs. frequency ( $V^+2$ )

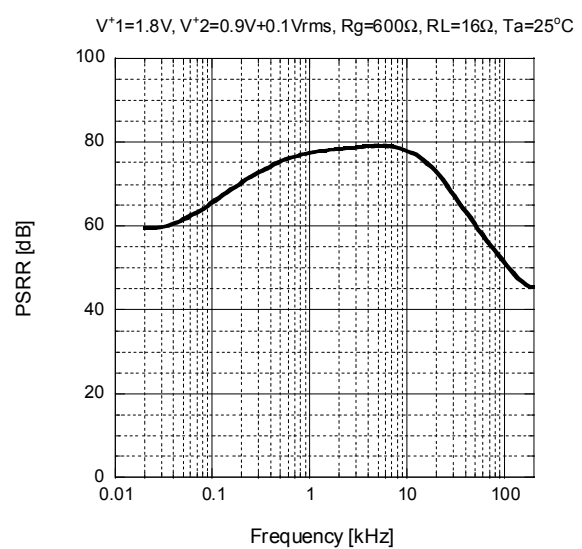

# NJM2776

## ■ TYPICAL CHARACTERISTICS

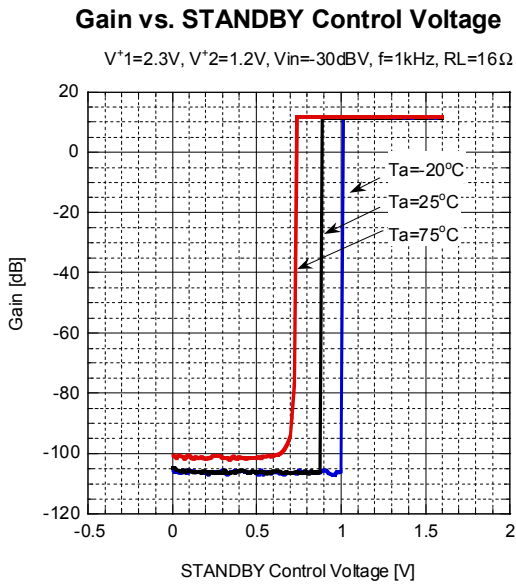

**[CAUTION]**

The specifications on this databook are only given for information, without any guarantee as regards either mistakes or omissions. The application circuits in this databook are described only to show representative usages of the product and not intended for the guarantee or permission of any right including the industrial rights.