



## AUDIO PROCESSOR with SOUND ENHANCEMENT

### ■ GENERAL DESCRIPTION

The **NJW1132A** is a sound processor with sound enhancement (BBE). It includes all of functions processing audio signal for TV, such as tone control, balance, volume, mute, and AGC functions.

Also the **NJW1132A** performs surround and sound enhancement. The sound enhancement regenerates high definitive and nearly real sound.

All of internal status and variables are controlled by I<sup>2</sup>C BUS interface.

### ■ PACKAGE OUTLINE

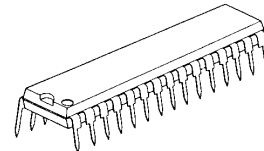

NJW1132AL

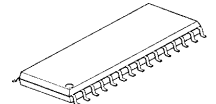

NJW1132AM

### ■ FEATURES

- Operating Voltage           8 to 13V
- I<sup>2</sup>C BUS Interface
- BBE Sound Enhancement (Low Boost and High Boost: 15dB max.)
- AGC Circuit (It reduces volume difference among input sources.)
- Matrix Surround
- Bi-CMOS Technology
- Package Outline           SDIP30, SDMP30

### ■ BLOCK DIAGRAM

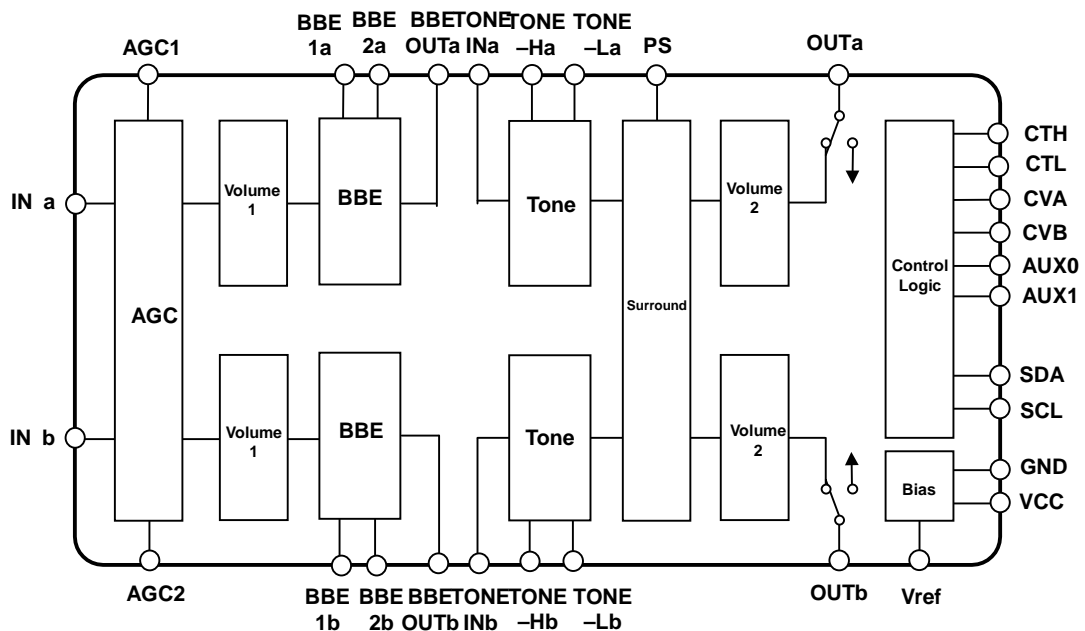

# NJW1132A

## ■ PIN FUNCTION



No.	Symbol	Function	No.	Symbol	Function
1	INa	Ach Input	16	Vcc	Power Supply Pin
2	BBE1a	Ach BBE Filter1	17	AUX1	Auxiliary Output1
3	BBE2a	Ach BBE Filter2	18	AUX0	Auxiliary Output0
4	BBEOUTa	Ach BBE Output	19	CTL	DAC Output for Tone Low Frequency
5	TONEINa	Ach Tone Input	20	CTH	DAC Output for Tone High Frequency
6	TONE-Ha	Ach Treble Filter	21	VREF	Reference Voltage
7	TONE-La	Ach Bass Filter	22	PS	Surround Phase Shift Filter
8	OUTa	Ach Output(0dB)	23	OUTb	Bch Output(0dB)
9	AGC1	AGC1	24	TONE-Lb	Bch Bass Filter
10	AGC2	AGC2	25	TONE-Hb	Bch Treble Filter
11	CVB	DAC Output for Bch Volume & Balance	26	TONEINb	Bch Tone Input
12	CVA	DAC Output for Ach Volume & Balance	27	BBEOUTb	Bch BBE Output
13	SDA	SDA Data Input (I2C BUS)	28	BBE2b	Bch BBE Filter2
14	SCL	SCL Data Input (I2C BUS)	29	BBE1b	Bch BBE Filter1
15	GND	GND	30	INb	Bch Input

## ■ABSOLUTE MAXIMUM RATING (Ta=25°C)

PARAMETER	SYMBOL	RATING	UNIT
Supply Voltage	V <sup>+</sup>	14	V
Power Dissipation	P <sub>D</sub>	700	mW
Operating Temperature Range	Topr	-20 to +75	°C
Storage Temperature Range	Tstg	-40 to +125	°C

## ■ELECTRICAL CHARACTERISTICS (Ta=25°C, V<sup>+</sup>=9V, R<sub>g</sub>=600Ω, R<sub>L</sub>=47kΩ, V<sub>in</sub>=100mVrms/1kHz)

PARAMETER	SYMBOL	TEST CONDITION	MIN.	TYP.	MAX.	UNIT
Operating Voltage	V <sup>+</sup>		8.0	9.0	13.0	V
Supply Current	I <sub>CC</sub>	No Signal	-	25	35	mA
Reference Voltage	V <sub>REF</sub>	No Signal	4.0	4.5	5.0	V
Maximum Input Voltage	V <sub>IM</sub>	VOL=C3H(-20dB),THD=1%	2.3	2.5	-	Vrms
Maximum Output Voltage	V <sub>OM1</sub>	OUTPUT VOL=FFH,THD=1%	-	2.5	-	Vrms
Maximum Gain	G <sub>VMAX</sub>	VOL=FFH	-2.0	0.0	2.0	dB
Minimum Gain	G <sub>VMIN</sub>	VOL=00H	-	-	-70	dB
Channel Balance	G <sub>CB</sub>	VOL=FFH	-1.5	0.0	1.5	dB
Balance Boost A	BA <sub>BST</sub>	CHS="0",BAL="11111"	-2.0	0.0	2.0	dB
Balance Cut A	BA <sub>CUT</sub>	CHS="1",BAL="11111" V <sub>in</sub> = 1Vrms	-	-	-70	dB
Balance Boost B	BB <sub>BST</sub>	CHS="1",BAL="11111"	-2.0	0.0	2.0	dB
Balance Cut B	BB <sub>CUT</sub>	CHS="0",BAL="11111" V <sub>in</sub> = 1Vrms	-	-	-70	dB
Total Harmonic Distortion	THD	V <sub>o</sub> =0.5Vrms BW=400Hz to 30kHz	-	-	0.5	%
Maximum Gain	G <sub>VMAX</sub>	VOL=FFH	-2.0	0.0	2.0	dB
Minimum Gain	G <sub>VMIN</sub>	VOL=00H	-	-	-70	dB
Channel Separation	CS	V <sub>in</sub> =2Vrms	-	-	-70	dB
Output Noise 1	V <sub>NO1</sub>	VOL=FFH BW=400Hz to 30kHz	-	-80 (100)	-70 (316)	dBV (μVrms)
Output Noise 2	V <sub>NO2</sub>	VOL=00H BW=400Hz to 30kHz	-	-90 (31.6)	-82 (79.4)	dBV (μVrms)
AUX Output Voltage	V <sub>AUX</sub>	Logic Output : High	4.5	-	5.0	V
		Logic Output : Low	0	-	0.3	

BW : Band Width

● **TONE CONTROL** (Ta=25°C, V+=9V, Rg=600Ω, RL=47kΩ, Vin=100mVrms/1kHz)

PARAMETER	SYMBOL	TEST CONDITION	MIN.	TYP.	MAX.	UNIT
High Frequency Boost	HF <sub>BST</sub>	BCT="1", TREB="1111", f=10kHz	12.5	15.0	17.5	dB
High Frequency Flat	HF <sub>FLT</sub>	TRBE="0000", f=10kHz	-2.0	0.0	2.0	dB
High Frequency Cut	HF <sub>CUT</sub>	BCT="0", TRBE="1111", f=10kHz	-12.5	-15.0	-17.5	dB
Low Frequency Boost	LF <sub>BST</sub>	BCB="1", BASS="1111", f=100Hz	12.5	15.0	17.5	dB
Low Frequency Flat	LF <sub>FLT</sub>	BASS="0000", f=100Hz	-2.0	0.0	2.0	dB
Low Frequency Cut	LF <sub>CUT</sub>	BCB="0", BASS="1111", f=100Hz	-12.5	-15.0	-17.5	dB
High Frequency Cut DC Offset1	HF <sub>DC1</sub>	BCT="0", TREB="1111" →"0000"	-1.0	0.0	1.0	V
High Frequency Boost DC Offset2	HF <sub>DC2</sub>	BCT="1", TREB="1111" →"0000"	-1.0	0.0	1.0	V
Low Frequency Cut DC Offset1	LF <sub>DC1</sub>	BCB="0", BASS="1111" →"0000"	-1.0	0.0	1.0	V
Low Frequency Boost DC Offset2	LF <sub>DC2</sub>	BCB="1", BASS="1111" →"0000"	-1.0	0.0	1.0	V

● **SUB-TONE CONTROL** (Ta=25°C, V+=9V, Rg=600Ω, RL=47kΩ, Vin=100mVrms)

PARAMETER	SYMBOL	TEST CONDITION	MIN.	TYP.	MAX.	UNIT
High Frequency Boost	SHF <sub>BST</sub>	BCST="0", SUB-TREB="11", f=10kHz	2.0	3.0	4.0	dB
High Frequency Flat	SHF <sub>FLT</sub>	SUB-TREB="00", f=10kHz	-2.0	0.0	2.0	dB
High Frequency Cut	SHF <sub>CUT</sub>	BCST="0", SUB-TREB="11", f=10kHz	-4.0	-3.0	-2.0	dB
Low Frequency Boost	SLF <sub>BST</sub>	BCSB="1", SUB-BASS="11", f=100Hz	2.0	3.0	4.0	dB
Low Frequency Flat	SLF <sub>FLT</sub>	SUB-BASS="00", f=100Hz	-2.0	0.0	2.0	dB
Low Frequency Cut	SLF <sub>CUT</sub>	BCSB="1", SUB-BASS="11", f=100Hz	-4.0	-3.0	-2.0	dB

● **AGC CONTROL: AGC=1H (AGC-ON)** (Ta=25°C, V+=9V, Rg=600Ω, RL=47kΩ, f=1kHz)

PARAMETER	SYMBOL	TEST CONDITION	MIN.	TYP.	MAX.	UNIT
AGC BOOST	AGC <sub>BST</sub>	Vin=50mVrms	1.5	3.5	5.5	dB
AGC FLAT	AGC <sub>FLT</sub>	Vin=150mVrms	-2.5	0.0	2.5	dB
AGC CUT	AGC <sub>CUT</sub>	Vin=2Vrms	-14	-10	-6.0	dB

● **SURROUND CONTROL** (Ta=25°C, V+=9V, Rg=600Ω, RL=47kΩ, Vin=100mVrms/1kHz)

PARAMETER	SYMBOL	TEST CONDITION	MIN.	TYP.	MAX.	UNIT
SURROUND MIX 1	SR <sub>MIX1</sub>	Ain → Bout	-2.0	0.0	2.0	dB
SURROUND MIX 2	SR <sub>MIX2</sub>	Bin → Aout	-2.0	0.0	2.0	dB
SURROUND DEF	SR <sub>DEF</sub>	Ain-Bin(-180deg)	8.0	10.0	12.0	dB
DC Offset	SR <sub>DC</sub>	SUR="0" →"1"	-1.0	0.0	1.0	V

● **BBE =1H (BBE-ON)** ( $T_a=25^\circ\text{C}$ ,  $V_+=9\text{V}$ ,  $R_g=600\Omega$ ,  $R_l=47\text{k}\Omega$ ,  $V_{in}=100\text{mVrms}$ )

PARAMETER	SYMBOL	TEST CONDITION	MIN.	TYP.	MAX.	UNIT
BBE low Frequency Boost Range	$\text{BBE}_{\text{LOW}}$	BBE-Low="1111", $f = 50\text{Hz}$	-	15.0	-	dB
BBE High Frequency Boost Range	$\text{BBE}_{\text{HIGH}}$	BBE-High="1111", $f = 10\text{KHz}$	-	15.0	-	dB

## ■ APPLICATION CIRCUIT

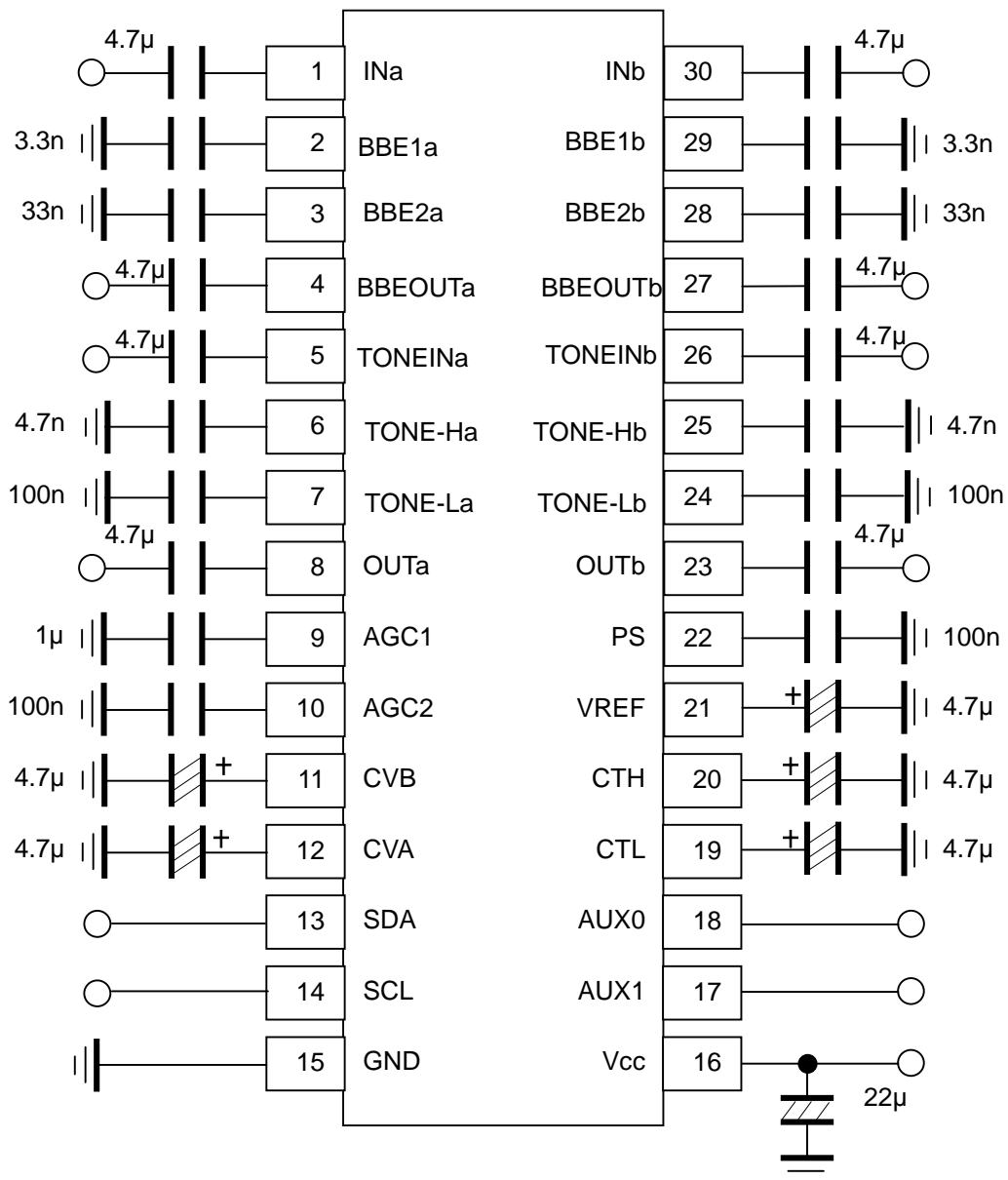

## ■ I<sup>2</sup>C BUS Block CHARACTERISTICS (SDA,SCL)

PARAMETER	SYMBOL	MIN.	TYP.	MAX.	UNIT
High Level Input Voltage	$V_{IH}$	3.0	-	5.0	V
Low Level Input Voltage	$V_{IL}$	0	-	1.5	V
High Level Input Current	$I_{IH}$	-	-	10	$\mu$ A
Low Level Input Current	$I_{IL}$	-	-	10	$\mu$ A
Low Level Output Voltage (3mA at SDA pin)	$V_{OL}$	0	-	0.4	V
Maximum Output Current	$I_{OL}$	-3.0	-	-	mA
Maximum Clock Frequency	$f_{SCL}$	0	-	100	kHz
Data Change Minimum Waiting Time	$t_{BUF}$	4.7	-	-	$\mu$ S
Data Transfer Start Minimum Waiting Time	$t_{HD:STA}$	4.0	-	-	$\mu$ S
Low Level Clock Pulse Width	$t_{LOW}$	4.7	-	-	$\mu$ S
High Level Clock Pulse Width	$T_{HIGH}$	4.0	-	-	$\mu$ S
Minimum Start Preparation Waiting Time	$t_{SU:STA}$	4.7	-	-	$\mu$ S
Minimum Data Hold Time	$t_{HD:DAT}$	5.0	-	-	$\mu$ S
Minimum Data Preparation Time	$t_{SU:DAT}$	250	-	-	nS
Rise Time	$t_R$	-	-	1.0	$\mu$ S
Fall Time	$t_F$	-	-	300	nS
Minimum Stop Preparation Waiting Time	$t_{SU:STO}$	4.7	-	-	$\mu$ S

I<sup>2</sup>C BUS Load Condition: Pull up resistance 4k $\Omega$  (Connected to +5V)  
Load capacitance 200pF (Connected to GND)

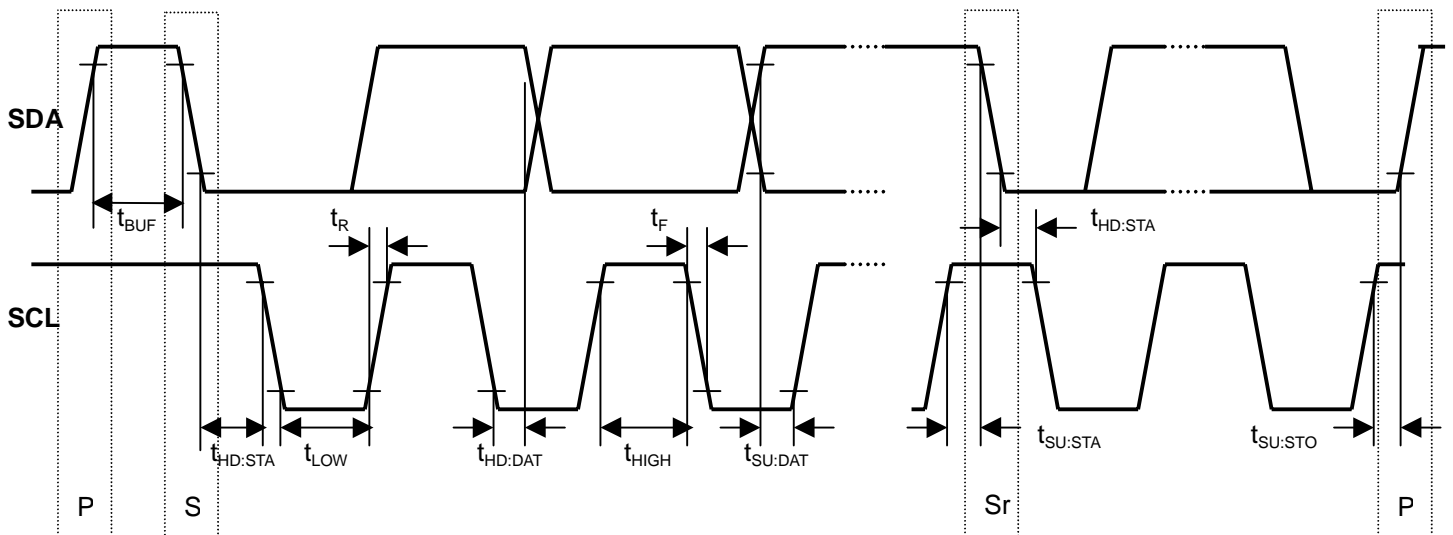

## ■ DEFINITION OF I<sup>2</sup>C REGISTER

### ● I<sup>2</sup>C BUS FORMAT

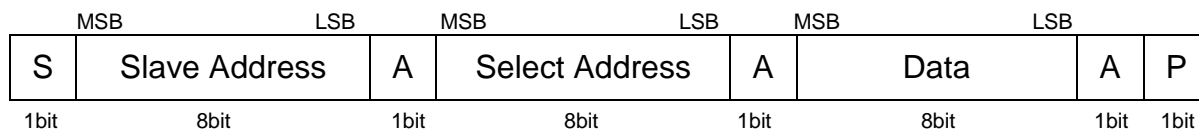

S: Starting Term  
A: Acknowledge Bit  
P: Ending Term

### ● SLAVE ADDRESS

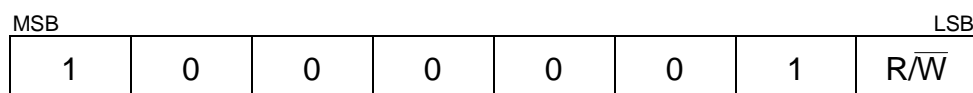

R/W=0: Receive Only  
R/W=1: No Output Data

### ● CONTROL REGISTER TABLE

The select address sets each function (Volume, Balance, AGC, Surround, Tone Control, BBE, AUX).  
The auto increment function cycles the select address as follows.  
00H→01H→02H→03H→04H→05H→00H

Select Address	BIT							
	D7	D6	D5	D4	D3	D2	D1	D0
00H	VOL							
01H	CHS	BAL					AGC	SUR
02H	BCB	BASS			BCSB	SUB-BASS		
03H	BCT	TREB			BCST	SUB-TREB		
04H	BBE-Low				BBE-High			
05H	OUT	Don't care					AUX1	AUX0

### ● CONTROL REGISTER DEFAULT VALUE

Control register default value is all "0".

Select Address	BIT							
	D7	D6	D5	D4	D3	D2	D1	D0
00H	0	0	0	0	0	0	0	0
01H	0	0	0	0	0	0	0	0
02H	0	0	0	0	0	0	0	0
03H	0	0	0	0	0	0	0	0
04H	0	0	0	0	0	0	0	0
05H	0	0	0	0	0	0	0	0

Send the I2C BUS data after 30msec from turn on.

## ■INSTRUCTION CODE

### a) MASTER VOLUME SETTING

Select Address	BIT							
	D7	D6	D5	D4	D3	D2	D1	D0
00H	VOL							

The volume control for both Ach and Bch(0.33dB/step).

The volume is consisted of volume1 and volume2 and the level is divided into half to each volume1 and volume2.

### b) BALANCE, AGC AND SURROUND SETTING

Select Address	BIT							
	D7	D6	D5	D4	D3	D2	D1	D0
01H	CHS	BAL					AGC	SUR

- CHS : Channel select for balance control

“0” : Ach “Bch is attenuated”

“1” : Bch “Ach is attenuated”

- BAL : Balance control for both Ach and Bch(1dB/Step)

The balance is consisted of volume1 and volume2 and the level is divided into half to each volume1 and volume2.

- AGC : AGC switch

“0” : AGC OFF

“1” : AGC ON

- SUR : Surround mode switch

“0” : Surround OFF

“1” : Surround ON

### c)TONE CONTROL BASS SETTING

Select Address	BIT							
	D7	D6	D5	D4	D3	D2	D1	D0
02H	BCB	BASS					BCSB	SUB-BASS

- BCB : Boost cut select for Bass control

“0” : Cut

“1” : Boost

- BASS: BASS control(1dB/Step)

- BCSB : Boost cut select for SUB-BASS control

“0” : Cut

“1” : Boost

- SUB-BASS: SUB- BASS control(1dB/Step)



### d) TONE CONTROL TREBLE SETTING

Select Address	BIT							
	D7	D6	D5	D4	D3	D2	D1	D0
03H	BCT	TREB				BCST	SUB-TREB	

- BCT : Boost cut select for Treble control  
   "0" : Cut  
   "1" : Boost
- TREB: Treble control(1dB/step)
- BCST : Boost cut select for Sub-Treble control  
   "0" : Cut  
   "1" : Boost
- SUB-TREB: Sub-Treble control(1dB/step)

### e) BBE Boost Level Setting

Select Address	BIT							
	D7	D6	D5	D4	D3	D2	D1	D0
04H	BBE-Low				BBE-High			

- BBE-Low : Boost level control for BBE Lo-Countour(1dB/step)
- BBE-High : Boost level control for BBE Process(1dB/step)

When all bits are "0"(=00H), BBE becomes off

### f) OUTPUT AND AUXILIARY SETTING

Select Address	BIT							
	D7	D6	D5	D4	D3	D2	D1	D0
05H	OUT	Don't Care				AUX1	AUX0	

- OUT: ON/OFF Switch for OUTPUT  
   "0" : OFF  
   "1" : ON
- AUX1/AUX2: Auxiliary port High/Low  
   "0" : Logic output "Low"  
   "1" : Logic output "High"

# NJW1132A

## ■MASTER VOLUME (Select Address : 00H)

Gain (dB)	HEX	VOL							
		D7	D6	D5	D4	D3	D2	D1	D0
0	FF	1	1	1	1	1	1	1	1
-1	FC	1	1	1	1	1	1	0	0
-2	F9	1	1	1	1	1	0	0	1
-3	F6	1	1	1	1	0	1	1	0
-4	F3	1	1	1	1	0	0	1	1
-5	F0	1	1	1	1	0	0	0	0
-6	ED	1	1	1	0	1	1	0	1
-7	EA	1	1	1	0	1	0	1	0
-8	E7	1	1	1	0	0	1	1	1
-9	E4	1	1	1	0	0	1	0	0
-10	E1	1	1	1	0	0	0	0	1
-11	DE	1	1	0	1	1	1	1	0
-12	DB	1	1	0	1	1	0	1	1
-13	D8	1	1	0	1	1	0	0	0
-14	D5	1	1	0	1	0	1	0	1
-15	D2	1	1	0	1	0	0	1	0
-16	CF	1	1	0	0	1	1	1	1
-17	CC	1	1	0	0	1	1	0	0
-18	C9	1	1	0	0	1	0	0	1
-19	C6	1	1	0	0	0	1	1	0
-20	C3	1	1	0	0	0	0	1	1
-21	C0	1	1	0	0	0	0	0	0
-22	BD	1	0	1	1	1	1	0	1
-23	BA	1	0	1	1	1	0	1	0
-24	B7	1	0	1	1	0	1	1	1
-25	B4	1	0	1	1	0	1	0	0
-26	B1	1	0	1	1	0	0	0	1
-27	AE	1	0	1	0	1	1	1	0
-28	AB	1	0	1	0	1	0	1	1
-29	A8	1	0	1	0	1	0	0	0
-30	A5	1	0	1	0	0	1	0	1
-31	A2	1	0	1	0	0	0	1	0
-32	9F	1	0	0	1	1	1	1	1
-33	9C	1	0	0	1	1	1	0	0
-34	99	1	0	0	1	1	0	0	1
-35	96	1	0	0	1	0	1	1	0
-36	93	1	0	0	1	0	0	1	1
-37	90	1	0	0	1	0	0	0	0
-38	8D	1	0	0	0	1	1	0	1
-39	8A	1	0	0	0	1	0	1	0
-40	87	1	0	0	0	0	1	1	1
-41	84	1	0	0	0	0	1	0	0
-42	81	1	0	0	0	0	0	0	1

		VOL							
Gain (dB)	HEX	D7	D6	D5	D4	D3	D2	D1	D0
-43	7E	0	1	1	1	1	1	1	0
-44	7B	0	1	1	1	1	0	1	1
-45	78	0	1	1	1	1	0	0	0
-46	75	0	1	1	1	0	1	0	1
-47	72	0	1	1	1	0	0	1	0
-48	6F	0	1	1	0	1	1	1	1
-49	6C	0	1	1	0	1	1	0	0
-50	69	0	1	1	0	1	0	0	1
-51	66	0	1	1	0	0	1	1	0
-52	63	0	1	1	0	0	0	1	1
-53	60	0	1	1	0	0	0	0	0
-54	5D	0	1	0	1	1	1	0	1
-55	5A	0	1	0	1	1	0	1	0
-56	57	0	1	0	1	0	1	1	1
-57	54	0	1	0	1	0	1	0	0
-58	51	0	1	0	1	0	0	0	1
-59	4E	0	1	0	0	1	1	1	0
-60	4B	0	1	0	0	1	0	1	1
-61	48	0	1	0	0	1	0	0	0
-62	45	0	1	0	0	0	1	0	1
-63	42	0	1	0	0	0	0	1	0
-64	3F	0	0	1	1	1	1	1	1
-65	3C	0	0	1	1	1	1	0	0
-66	39	0	0	1	1	1	0	0	1
-67	36	0	0	1	1	0	1	1	0
-68	33	0	0	1	1	0	0	1	1
-69	30	0	0	1	1	0	0	0	0
-70	2D	0	0	1	0	1	1	0	1
-71	2A	0	0	1	0	1	0	1	0
-72	27	0	0	1	0	0	1	1	1
-73	24	0	0	1	0	0	1	0	0
-74	21	0	0	1	0	0	0	0	1
-75	1E	0	0	0	1	1	1	1	0
-76	1B	0	0	0	1	1	0	1	1
-77	18	0	0	0	1	1	0	0	0
-78	15	0	0	0	1	0	1	0	1
-79	12	0	0	0	1	0	0	1	0
-80	0F	0	0	0	0	1	1	1	1
-81	0C	0	0	0	0	1	1	0	0
-82	09	0	0	0	0	1	0	0	1
-83	06	0	0	0	0	0	1	1	0
-84	03	0	0	0	0	0	0	1	1
Mute	00	0	0	0	0	0	0	0	0

■BALANCE (Select Address : 01H)

Channel Select (CHS)	D7
Ach	0
Bch	1

Gain(dB)	BAL				
	D6	D5	D4	D3	D2
0	0	0	0	0	0
-1	0	0	0	0	1
-2	0	0	0	1	0
-3	0	0	0	1	1
-4	0	0	1	0	0
-5	0	0	1	0	1
-6	0	0	1	1	0
-7	0	0	1	1	1
-8	0	1	0	0	0
-9	0	1	0	0	1
-10	0	1	0	1	0
-11	0	1	0	1	1
-12	0	1	1	0	0
-13	0	1	1	0	1
-14	0	1	1	1	0
-15	0	1	1	1	1
-16	1	0	0	0	0
-17	1	0	0	0	1
-18	1	0	0	1	0
-19	1	0	0	1	1
-20	1	0	1	0	0
-21	1	0	1	0	1
-22	1	0	1	1	0
-23	1	0	1	1	1
-24	1	1	0	0	0
-25	1	1	0	0	1
-26	1	1	0	1	0
-27	1	1	0	1	1
-28	1	1	1	0	0
-29	1	1	1	0	1
-30	1	1	1	1	0
Mute	1	1	1	1	1

■TONE CONTROL BASS (Select Address : 02H)

	BCB
<b>Bass Cut or Boost</b>	<b>D7</b>
Cut	0
Boost	1

		BASS			
Cut Gain(dB)	Boost Gain(dB)	D6	D5	D4	D3
-15	15	1	1	1	1
-14	14	1	1	1	0
-13	13	1	1	0	1
-12	12	1	1	0	0
-11	11	1	0	1	1
-10	10	1	0	1	0
-9	9	1	0	0	1
-8	8	1	0	0	0
-7	7	0	1	1	1
-6	6	0	1	1	0
-5	5	0	1	0	1
-4	4	0	1	0	0
-3	3	0	0	1	1
-2	2	0	0	1	0
-1	1	0	0	0	1
0	0	0	0	0	0

■TONE CONTROL SUB-BASS (Select Address : 02H)

	BCSB
<b>Sub-Bass Cut or Boost</b>	<b>D2</b>
Cut	0
Boost	1

		SUB-BASS	
Cut Gain(dB)	Boost Gain(dB)	D1	D0
-3	3	1	1
-2	2	1	0
-1	1	0	1
0	0	0	0

## ■TONE CONTROL TREBLE (Select Address : 03H)

	BCT
<b>Treble Cut or Boost</b>	<b>D7</b>
Cut	0
Boost	1

		TREB			
Cut Gain(dB)	Boost Gain(dB)	D6	D5	D4	D3
-15	15	1	1	1	1
-14	14	1	1	1	0
-13	13	1	1	0	1
-12	12	1	1	0	0
-11	11	1	0	1	1
-10	10	1	0	1	0
-9	9	1	0	0	1
-8	8	1	0	0	0
-7	7	0	1	1	1
-6	6	0	1	1	0
-5	5	0	1	0	1
-4	4	0	1	0	0
-3	3	0	0	1	1
-2	2	0	0	1	0
-1	1	0	0	0	1
0	0	0	0	0	0

## ■TONE CONTROL SUB-TREBLE (Select Address : 03H)

	BCST
<b>Sub-Treble Cut or Boost</b>	<b>D2</b>
Cut	0
Boost	1

		SUB-TREB	
Cut Gain(dB)	Boost Gain(dB)	D1	D0
-3	3	1	1
-2	2	1	0
-1	1	0	1
0	0	0	0

■BBE Low(Lo Contour) / High(Process) Gain Code

Gain(dB)	BBE-Low(Lo Contour)				BBE-High(Process)			
	D7	D6	D5	D4	D3	D2	D1	D0
15	1	1	1	1	1	1	1	1
14	1	1	1	0	1	1	1	0
13	1	1	0	1	1	1	0	1
12	1	1	0	0	1	1	0	0
11	1	0	1	1	1	0	1	1
10	1	0	1	0	1	0	1	0
9	1	0	0	1	1	0	0	1
8	1	0	0	0	1	0	0	0
7	0	1	1	1	0	1	1	1
6	0	1	1	0	0	1	1	0
5	0	1	0	1	0	1	0	1
4	0	1	0	0	0	1	0	0
3	0	0	1	1	0	0	1	1
2	0	0	1	0	0	0	1	0
1	0	0	0	1	0	0	0	1
0	0	0	0	0	0	0	0	0





## ■ TERMINAL DESCRIPTION

No.	SYMBOL	FUNCTION	EQUIVALENT CIRCUIT	VOLTAGE
6 25	TONE-Ha TONE-Hb	A/Bch Treble Filter		VCC/2
7 24	TONE-La TONE-Lb	A/Bch Bass Filter		VCC/2
8 23	OUTa OUTb	Output Pin		VCC/2
9	AGC1	AGC1		0.7V

# NJW1132A

## ■TERMINAL DESCRIPTION

No.	SYMBOL	FUNCTION	EQUIVALENT CIRCUIT	VOLTAGE
10	AGC2	AGC2		VCC/2
11 12	CVB CVA	DAC Output for A/Bch Volume & Balance		1.4V
13 14	SDA SCL	SDA Data Input (I2C BUS) SCL Data Input (I2C BUS)		-
15	GND	GND Pin		-
16	VCC	Voltage Supply Pin		-

## ■ TERMINAL DESCRIPTION

No.	SYMBOL	FUNCTION	EQUIVALENT CIRCUIT	VOLTAGE
17 18	AUX1 AUX0	Auxiliary Output		5V 0V
19 20	CTL CTH	DAC Output for Tone Low Frequency DAC Output for Tone High Frequency		1.4V
21	VREF	Reference Voltage		VCC/2
22	PS	Surround Phase Shift Filter		VCC/2

## ■ TYPICAL CHARACTERISTICS

**Operating Current vs Operating Voltage**  
No Signal

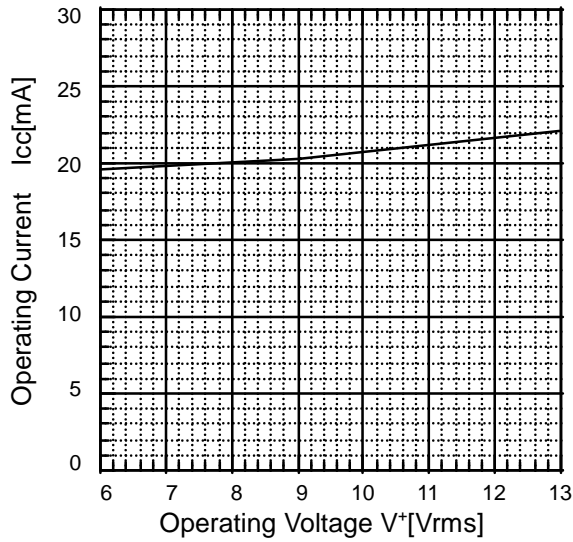

**Total Harmonic Distortion vs. Input Voltage**  
f=1kHz

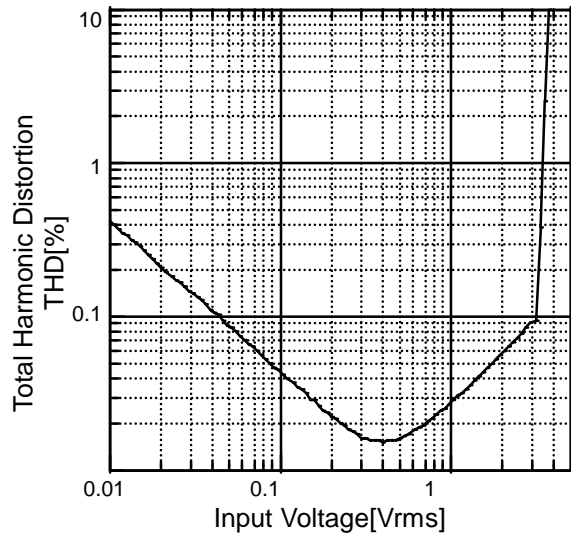

**Cross Talk**  
Vin = 6dBV(2Vrms)

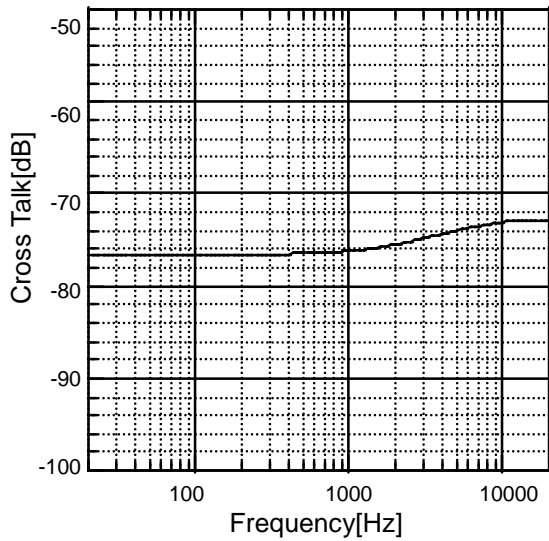

**Channel Separation**  
Vin = +6dBV (2Vrms)

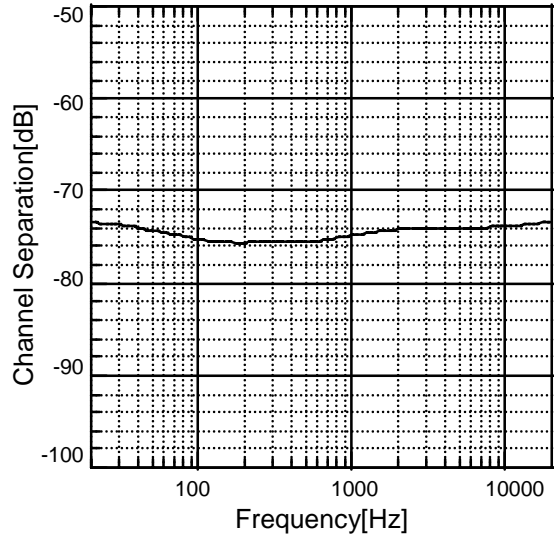

**AGC**

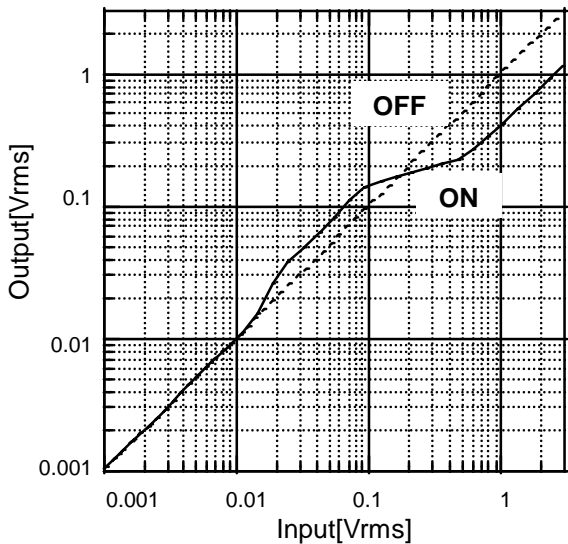

**Balance Control**  
Vin=1Vrms/1kHz

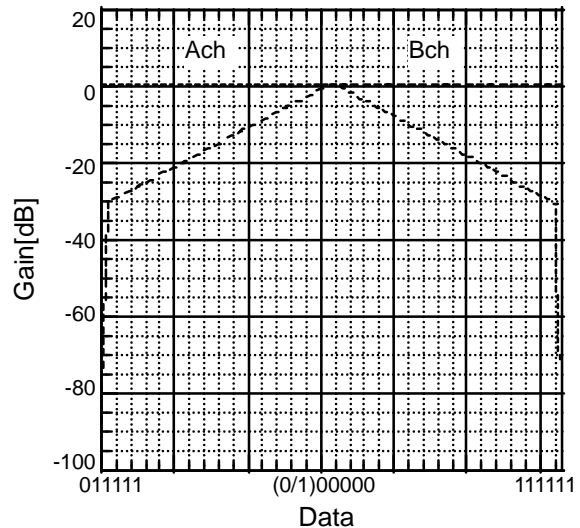

**Master Volume**

Vin = 1Vrms / 1kHz

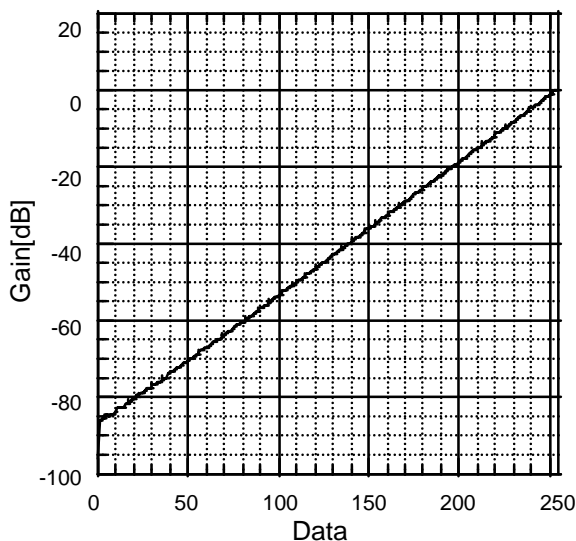

**Tone Control**

Vin = 100mVrms

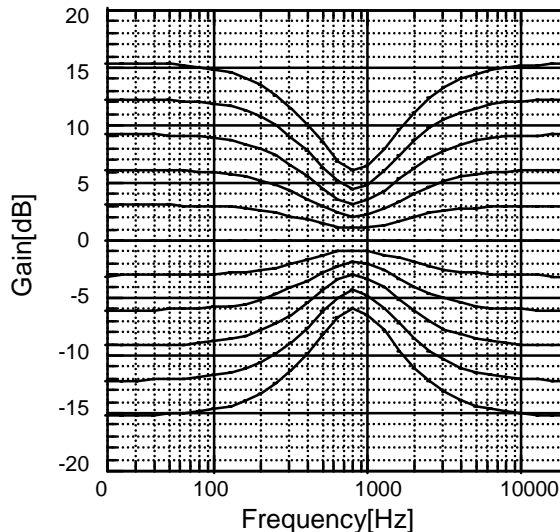

**BBE Response**

Vin = 1Vrms / 1kHz

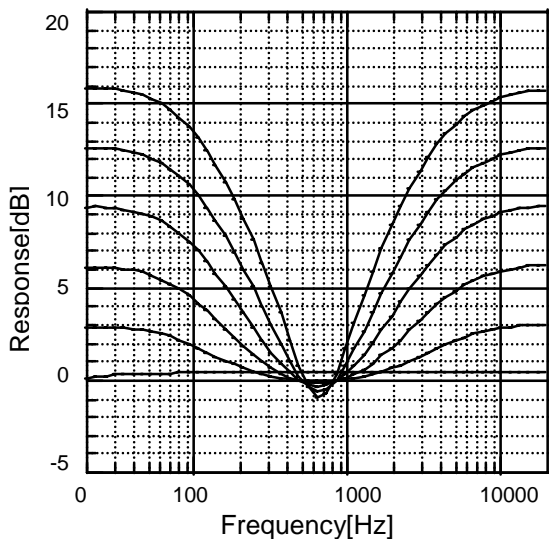

**BBE Phase**

+6dB Boost

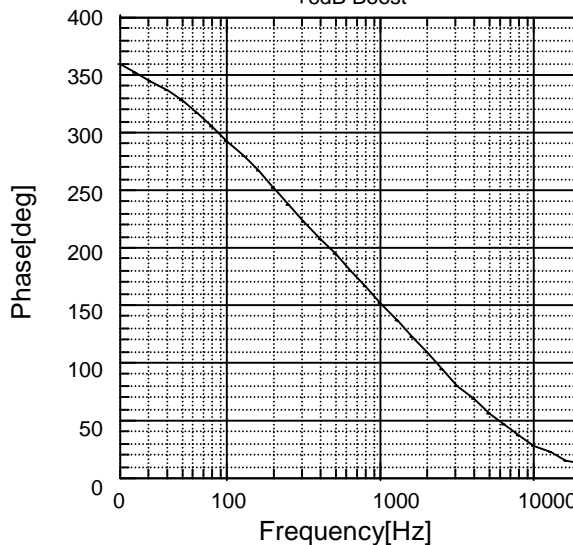

**NOTE**

The **NJW1132A** is manufactured by New Japan Radio Co., Ltd. under license from BBE Sound Inc. BBE is a registered trademark of BBE Sound Inc.

A license from BBE Sound Inc. is required before the **NJW1132A** can be purchased from New Japan Radio Co.,Ltd.

Purchase of I<sup>2</sup>C components of New Japan Radio Co., Ltd or one of its sublicensed Associated Companies conveys a license under the Philips I<sup>2</sup>C Patent Rights to use these components in an I<sup>2</sup>C system, provided that the system conforms to the I<sup>2</sup>C Standard Specification as defined by Philips.

BBE Sound, Inc.  
5381 Production Drive  
Huntington Beach, CA 92649  
Tel:(714)897-6766  
Fax:(714)896-0736

[CAUTION]  
The specifications on this databook are only given for information, without any guarantee as regards either mistakes or omissions. The application circuits in this databook are described only to show representative usages of the product and not intended for the guarantee or permission of any right including the industrial rights.