

30A, 600V Ultrafast Diode

The RURP3060 is an ultrafast diode ($t_{rr} < 55ns$) with soft recovery characteristics. It has a low forward voltage drop and is of planar, silicon nitride passivated, ion-implanted, epitaxial construction.

This device is intended for use as an energy steering/clamping diode and rectifier in a variety of switching power supplies and other power switching applications. Its low stored charge and ultrafast recovery with soft recovery characteristics minimize ringing and electrical noise in many power switching circuits, thus reducing power loss in the switching transistor.

Formerly developmental type TA09903.

Ordering Information

PART NUMBER	PACKAGE	BRAND
RURP3060	TO-220AC	RURP3060

NOTE: When ordering, use the entire part number.

Symbol



Features

- Ultrafast with Soft Recovery < 55ns
- Operating Temperature 175°C
- Reverse Voltage 600V
- Avalanche Energy Rated
- Planar Construction

Applications

- Switching Power Supply
- Power Switching Circuits
- General Purpose

Packaging

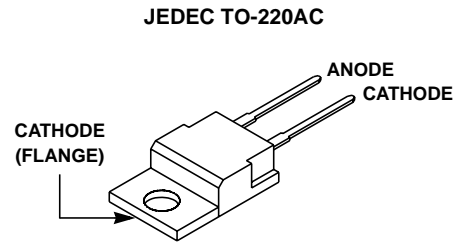

Absolute Maximum Ratings $T_C = 25^{\circ}C$, Unless Otherwise Specified

	RURP3060	UNITS
Peak Repetitive Reverse Voltage V_{RRM}	600	V
Working Peak Reverse Voltage V_{RWM}	600	V
DC Blocking Voltage V_R	600	V
Average Rectified Forward Current ($T_C = 130^{\circ}C$) $I_{F(AV)}$	30	A
Repetitive Peak Surge Current I_{FRM} (Square Wave, 20kHz)	70	A
Nonrepetitive Peak Surge Current I_{FSM} (Halfwave 1 Phase 60Hz)	325	A
Maximum Power Dissipation P_D	125	W
Avalanche Energy (See Figures 7 and 8) E_{AVL}	20	mJ
Operating and Storage Temperature T_{STG}, T_J	-55 to 175	°C

Electrical Specifications $T_C = 25^\circ\text{C}$, Unless Otherwise Specified

SYMBOL	TEST CONDITION	MIN	TYP	MAX	UNITS
V_F	$I_F = 30\text{A}$	-	-	1.5	V
	$I_F = 30\text{A}, T_C = 150^\circ\text{C}$	-	-	1.3	V
I_R	$V_R = 600\text{V}$	-	-	250	μA
	$V_R = 600\text{V}, T_C = 150^\circ\text{C}$	-	-	1	mA
t_{rr}	$I_F = 1\text{A}, dI_F/dt = 100\text{A}/\mu\text{s}$	-	-	55	ns
	$I_F = 30\text{A}, dI_F/dt = 100\text{A}/\mu\text{s}$	-	-	60	ns
t_a	$I_F = 30\text{A}, dI_F/dt = 100\text{A}/\mu\text{s}$	-	30	-	ns
t_b	$I_F = 30\text{A}, dI_F/dt = 100\text{A}/\mu\text{s}$	-	20	-	ns
$R_{\theta JC}$		-	-	1.2	$^\circ\text{C}/\text{W}$

DEFINITIONS

V_F = Instantaneous forward voltage (pw = 300 μs , D = 2%).

I_R = Instantaneous reverse current.

t_{rr} = Reverse recovery time at $dI_F/dt = 100\text{A}/\mu\text{s}$ (See Figure 6), summation of $t_a + t_b$.

t_a = Time to reach peak reverse current at $dI_F/dt = 100\text{A}/\mu\text{s}$ (See Figure 6).

t_b = Time from peak I_{RM} to projected zero crossing of I_{RM} based on a straight line from peak I_{RM} through 25% of I_{RM} (See Figure 6).

$R_{\theta JC}$ = Thermal resistance junction to case.

pw = Pulse width.

D = Duty cycle.

Typical Performance Curves

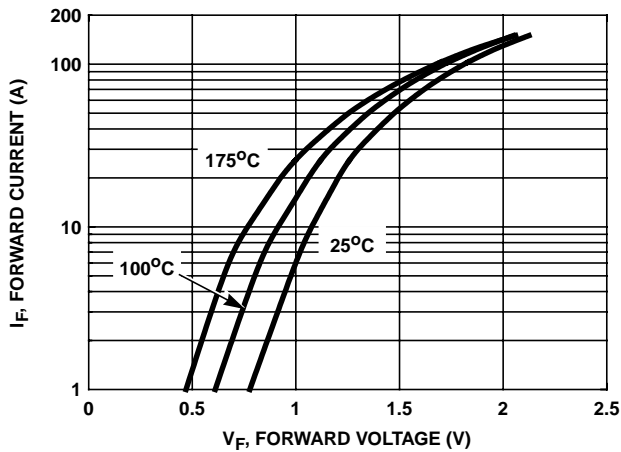

FIGURE 1. FORWARD CURRENT vs FORWARD VOLTAGE

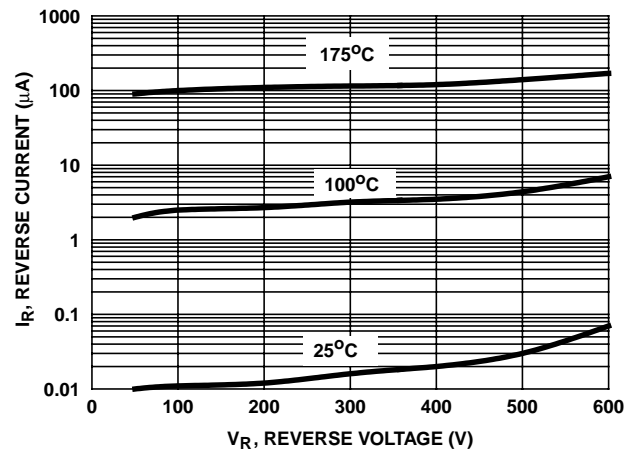

FIGURE 2. REVERSE CURRENT vs REVERSE VOLTAGE

Typical Performance Curves (Continued)

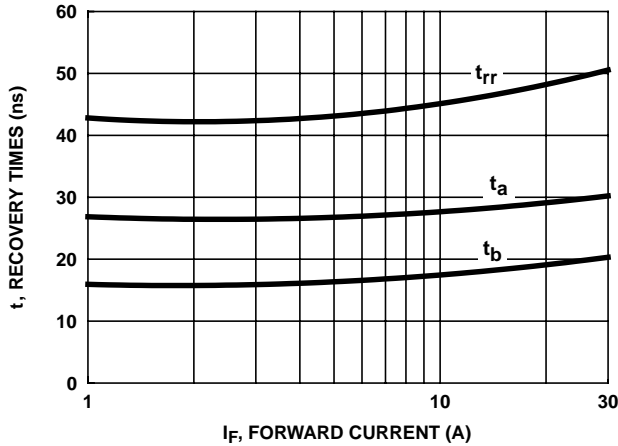

FIGURE 3. t_{rr} , t_a AND t_b CURVES vs FORWARD CURRENT

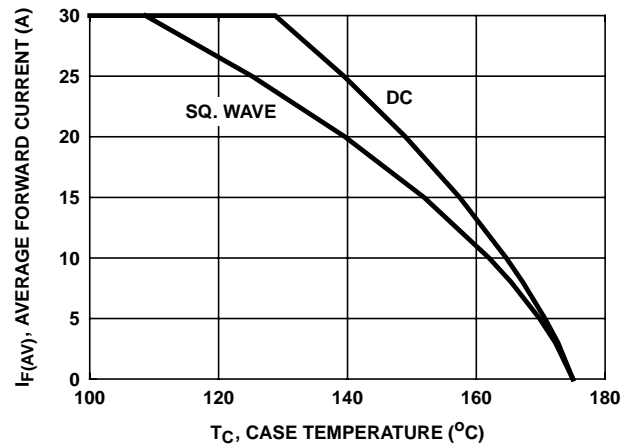

FIGURE 4. CURRENT DERATING CURVE

Test Circuits and Waveforms

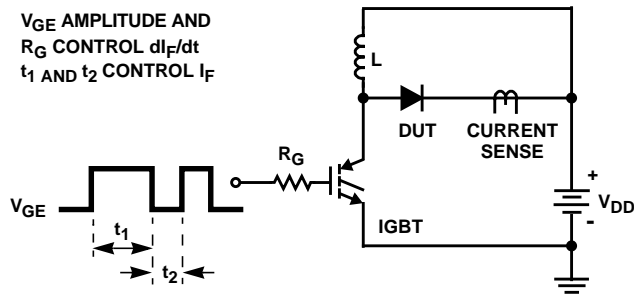

FIGURE 5. t_{rr} TEST CIRCUIT

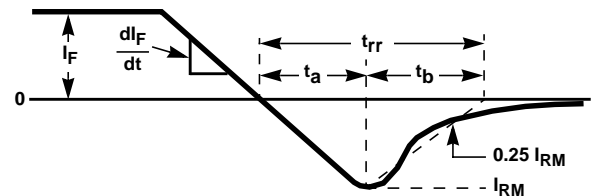

FIGURE 6. t_{rr} WAVEFORMS AND DEFINITIONS

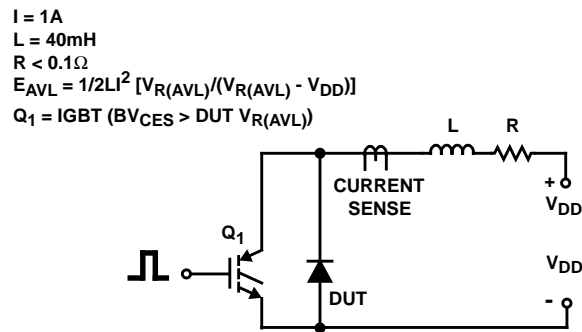

FIGURE 7. AVALANCHE ENERGY TEST CIRCUIT

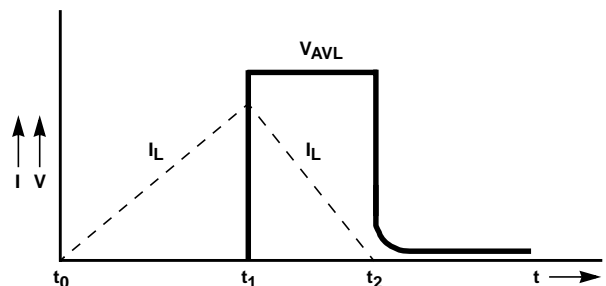

FIGURE 8. AVALANCHE CURRENT AND VOLTAGE WAVEFORMS

All Intersil semiconductor products are manufactured, assembled and tested under **ISO9000** quality systems certification.

Intersil semiconductor products are sold by description only. Intersil Corporation reserves the right to make changes in circuit design and/or specifications at any time without notice. Accordingly, the reader is cautioned to verify that data sheets are current before placing orders. Information furnished by Intersil is believed to be accurate and reliable. However, no responsibility is assumed by Intersil or its subsidiaries for its use; nor for any infringements of patents or other rights of third parties which may result from its use. No license is granted by implication or otherwise under any patent or patent rights of Intersil or its subsidiaries.

For information regarding Intersil Corporation and its products, see web site www.intersil.com