

I²C BUS interface, general purpose I/O ports with condition watching function

BU9929FV

ROHM's GPIO is a general-purpose IO that contains I²C BUS interface. It also contains monitoring function that conveys a change of the signal level in terminal to the host system via interrupt terminal or I²C BUS.

●Applications

Notebook PC, PC, VCR, TV etc. and other systems with I²C BUS.

●Features

- 1) I²C BUS interface
- 2) General purpose I/O port 16bits
- 3) State monitoring function to monitor all terminals
- 4) State detection signal serial output by I²C BUS master function
- 5) Output port of state detection signal
- 6) State detection ON/OFF setting input port during the default status
- 7) 32.768kHz clock input
- 8) Power supply voltage 3.3V / 5.0V

●Absolute maximum ratings (Ta=25°C)

Parameter	Symbol	Limits	Unit
Supply voltage	V _{DD}	7.0	V
Power dissipation	P _d	640	mW
Operating temperature	T _{opr}	-15 to +75	°C
Storage temperature	T _{sig}	-55 to +125	°C
Terminal supply voltage	V _{IN}	GND-0.5 to V _{DD} +0.5	V

*Temperature derating : 6.4mW/°C over Ta=25°C

© Radiation resistance is not included in the design.

© Rohm CO., Ltd is a licensee of I²C BUS from Philips Semiconductors.

●Recommended operating conditions (Ta=25°C)

Parameter	Min.	Typ.	Max.	Unit
Operating supply voltage range	3.0	-	5.5	V

Multimedia ICs

●Block diagram

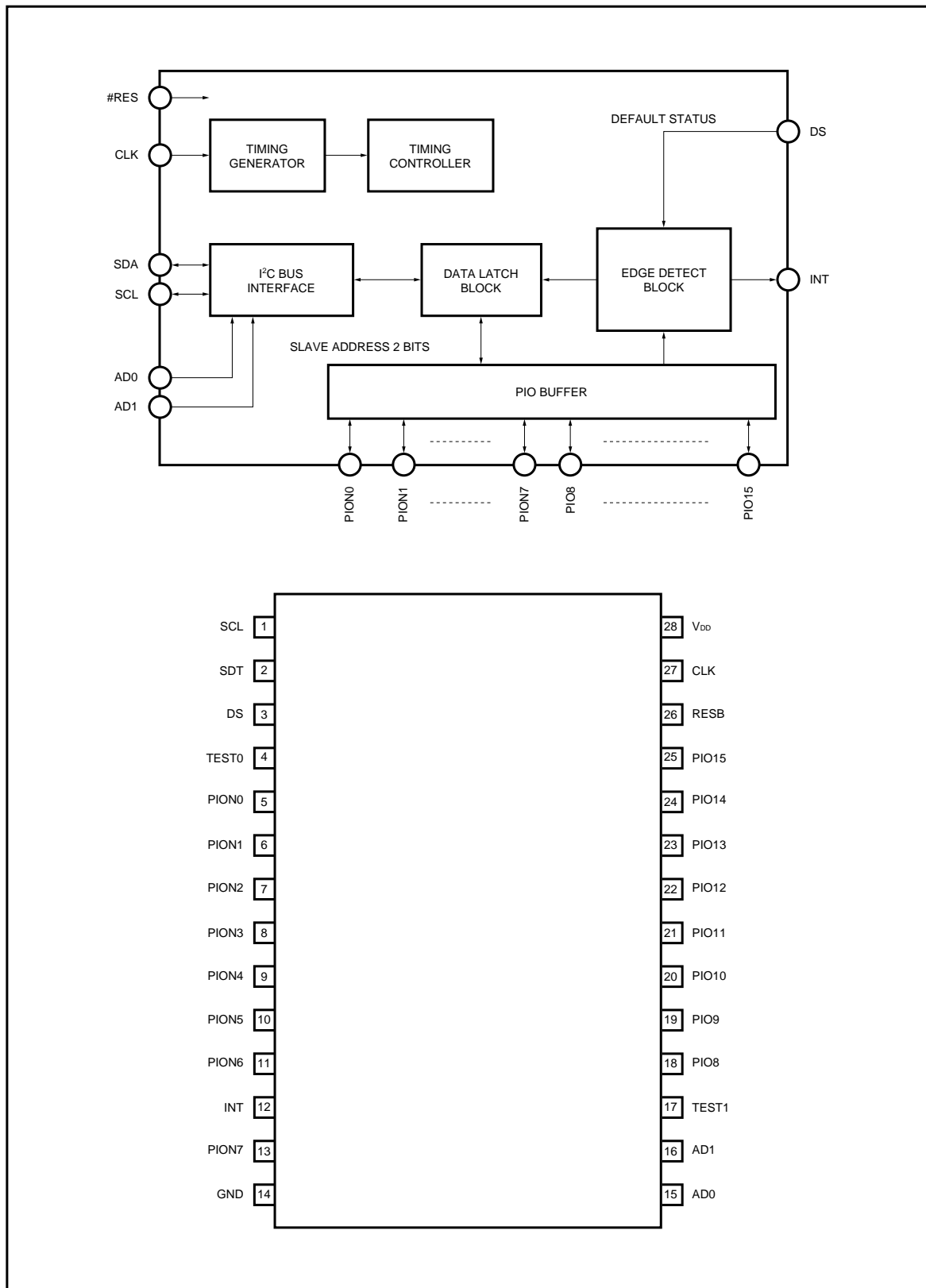

Multimedia ICs

●Pin description

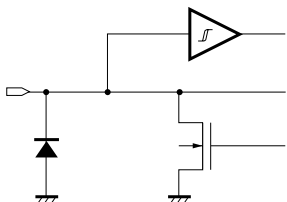
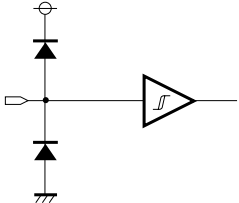
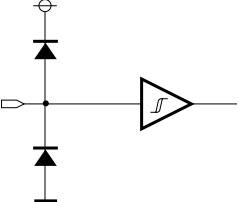
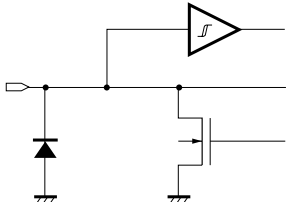
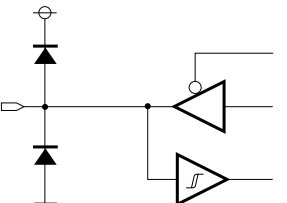
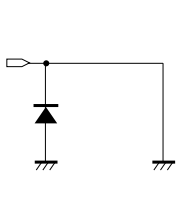
Pin. No	Pin. Name	I/O circuit	Pin Description
1 2	SCL SDT		I ² C BUS Input/Output terminal
3	DS		To set condition detection mode at default state
26	RES#		Reset terminal Reset condition by "L" input
5-11,13	PION		Nch open drain standard input/output terminal. Input at TTL level. This waits for condition detection function of input. Output will be Hi-Z at Shut Down mode. 5V input is possible when this IC is operated by 3.3V.
18-25	PIO		Standard input/output terminal. Input at TTL level. This waits for condition detection function of input. Output will be Hi-Z at Shut Down mode.
14	GND		GND terminal

Multimedia ICs

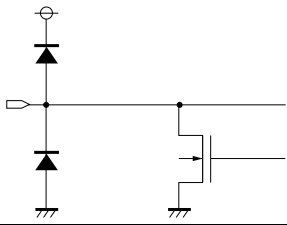
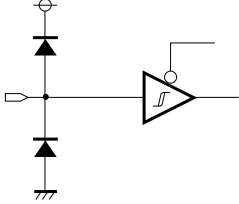
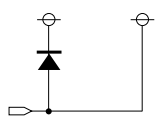
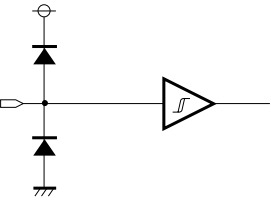
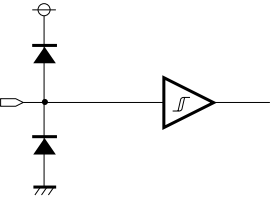
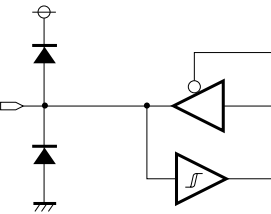
Pin. No	Pin. Name	I/O circuit	Pin Description
12	INT		Output terminal for condition change detection. Nch open drain output.
27	CLK		Clock input terminal. 32.768KHz should be put. At Shut Down mode, clock supply into this IC will be shut down.
28	V _{DD}		Power terminal. 3.3V/5.0V should be put in.
15 16	AD0 AD1		Input terminal for setting of I ² C BUS Slave address lower 2 bits.
4	TEST0		IC TEST Pin. "L" Input required for normal operation.
17	TEST1		IC TEST Pin. "L" Input required for normal operation.

Multimedia ICs

●Electrical characteristics (Unless otherwise noted, $V_{DD}=5.0V$, $T_a=25^{\circ}C$)

Parameter	Symbol	Min.	Typ.	Max.	Unit	Conditions	Test Pin No.
Circuit current (Normal)	I_{DD}	–	6.0	30	μA	CLK=32.768Hz	28
Circuit current (Shut down mode)	I_{DS}	–	0.1	2.0	μA	Shut Down Mode	28
"H" Level input voltage 1	V_{IH1}	$V_{DD} \times 0.7$	V_{DD}	$V_{DD} + 0.5$	V		1, 2
"L" Level input voltage 1	V_{IL1}	–0.5	0.0	$V_{DD} \times 0.3$	V		1, 2
"H" Level input voltage 2	V_{IH2}	2.5	V_{DD}	$V_{DD} + 0.5$	V		3, 4, 15-17
"L" Level input voltage 2	V_{IL2}	–0.5	0.0	0.8	V		3-5, 11, 13 15-27
"H" Level input voltage 3	V_{IH3}	2.5	V_{DD}	5.5	V		5-11, 13
"H" Level input Current	I_{IH}	2.0	0.0	1.0	μA		3-5, 11, 13 15-27
"L" Level input Current	I_{IL}	–1.0	0.0	–	μA		3-5, 11, 13 15-27
"H" Level output voltage	V_{SOH}	4.4	4.8	5.0	V	$I_{OH}=4mA$	18-25
"L" Level output voltage 1	V_{SOL}	0.0	0.2	0.6	V	$I_{OL}=4mA$	5-13, 18-25
"L" Level output voltage 2	V_{COL}	0.0	0.2	0.6	V	$I_{OL}=6mA$	1, 2
I ² C Fall time	TFIC	–	100	250	ns	$I_{OL}=6mA$ CL=400pF	1, 2

Multimedia ICs

I²C BUS Interface characteristics (Unless otherwise noted, V_{DD}=5.0V, Ta=25°C)

●Slave address

0	1	1	1	1	A1	A0	R / W
MSB						LSB	

A0 and A1 are set by input terminals of AD0 and AD1 as follows;

When AD0 / AD1=H, A0 / A1=1

When AD0 / AD1=L, A0 / A1=0

●Conforming to I²C BUS standard

Parameter	Symbol	Min.	Max.	Unit
SCL clock frequency	f SCL	0	400	kHz
Start condition hold time	t HD : STA	0.6	–	μs
Start condition set-up time	t SU : STA	0.6	–	μs
Data set-up time	t SU : DAT	100	–	ns
Data hold time	t HD : DAT	0	0.9	μs
Stop condition set-up time	t SU : STO	0.6	–	μs

(Start Timing)

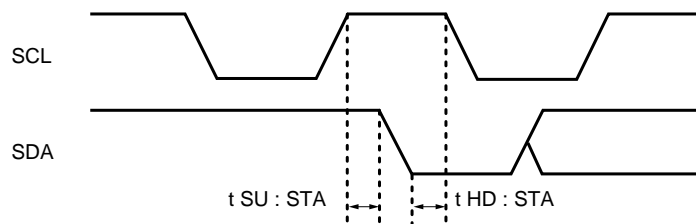

(Data Timing)

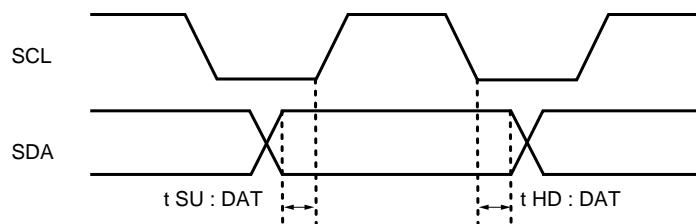

(Stop Timing)

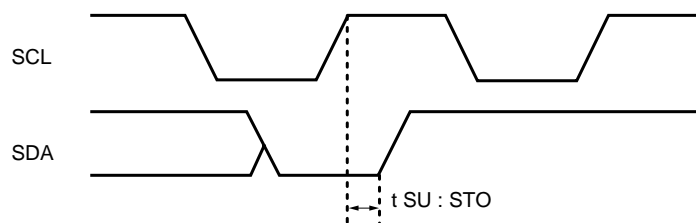

Multimedia ICs

1. Data write mode

St	SLAVE ADDRESS	\bar{W}	A	COMMAND BYTE	A	WRITE DATA 1	A	WRITE DATA 2	A	Sp
				PION7 – PION0						
							PIO15 – PIO8			

Command register : At reset, D0 to D7 are "0".

D7	D6	D5	D4	D3	D2	D1	D0
SHT DWN	INT SEL	DOUT SEL	OUT ON	DIR ON	BYTE SEL	EDGE SEL	DET ON

D7 : Shut Down mode

0 : Shut down mode off (Normal operation mode)

1 : Shut down mode on

D6 : INT output method choice

0 : LOW output

1 : Output of LOW pulse equivalent for one period of CLK

D5 : Detection result output choice

0 : Serial output. INT pin is also valid.

1 : Serial output (I²C MASTER function) off. Only INT pin is valid.

D4 : Output port writing set

0 : Writing invalid

1 : Writing valid. But, a port, which is indicated as input, is invalid.

Following Write data 2byte-0 : "L" output, 1 : "H" output

D3 : I / O direction set

0 : Direction set invalid

1 : Direction set valid

Following Write data 2byte-0 : input, 1 : output

D2 : Watching object input choice

0 : PION0 to PION7

1 : PION8 to PIO15

D1 : Change detection mode

0 : Falling edge

1 : Both rising and falling edge

D0 : Input port condition watching mode

0 : Invalid

1 : Valid

Multimedia ICs

2. Data read mode

According to the following format, input/output value of PIO/PION pins can be read by I²C interface.

PIO data read

St	SLAVE ADDRESS	R	A	READ DATA 1	A	READ DATA 2	\bar{A}	Sp
				PION7 – PION0		PIO15 – PIO8		

PIO part block diagram

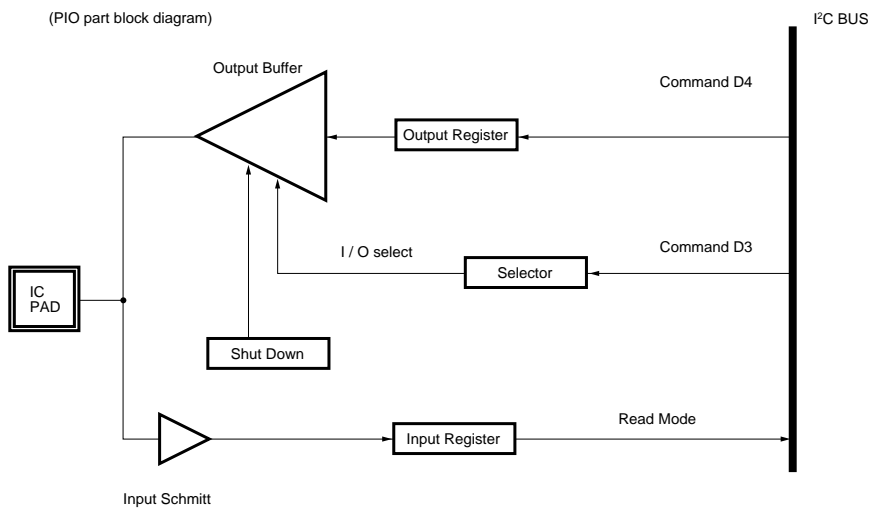

Input Port sampling timing

As shown below, BU9929FV is sampling for Input Ports with the rising edges of CLK.

Therefore it is necessary that Input Ports are keeping at least 1 CLK cycle, for their certain inputs.

Watching Ports

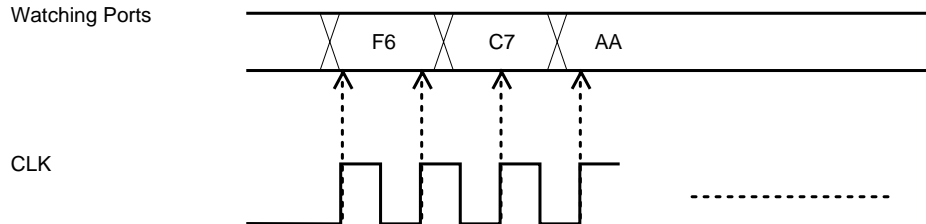

Multimedia ICs

3. Condition change detection result output mode

1) This IC becomes I²C master device, and the detection result is sent according to the following format;

2Byte Watching

St	0	0	0	1	0	0	0	\bar{W}	A	SLAVE ADDRESS +0	A	WRITE DATA 1	A	WRITE DATA 2	A	Sp
											PION7 – PION0		PIO15 – PIO8			

1Byte Watching

St	0	0	0	1	0	0	0	\bar{W}	A	SLAVE ADDRESS +0	A	WRITE DATA 1	A	Sp
											PION7 – PION0			

<DATA Keeping Operation>

In a case that there is a change in detection port during detection result transmission, then watching data is saved by the end of detection output, and it will be proceeded further after the detection output is finished. However, the output data in this case will be “AND” output of every bits of the watching data.

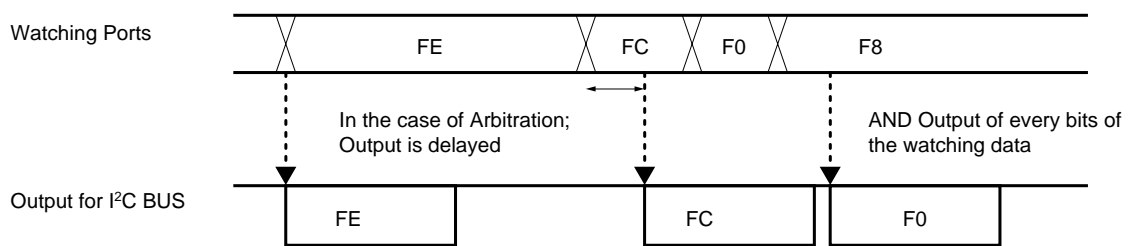

2) DS pin Description

By DS pin, valid/invalid of condition detection of the default condition (from RESET release to reception of the first I²C command) can be set.

<DS pic valid range>

In the range from RESET release to the first set of condition detection mode by I²C command, the set of this pin will be valid. After the set of condition detection mode by I²C command, this pin will be invalid, and the set by I²C commanded will be reflected.

<Pin setting>

DS pin= “H” : Input bit condition detection mode is valid.

But, 1 byte detection mode (only PION7-PION0 will be in condition detection)

DS pin=“L” : Input bit condition detection mode is invalid.

Multimedia ICs

3) INT pin specification

When condition watching mode, INT output pin works for reporting of detection of watching port.

(a) When command D6=0(including default time after RESET release)

INT pin falls when detection of watching port is received. And INT pin rises after ACK-output which is on the I²C Data read.

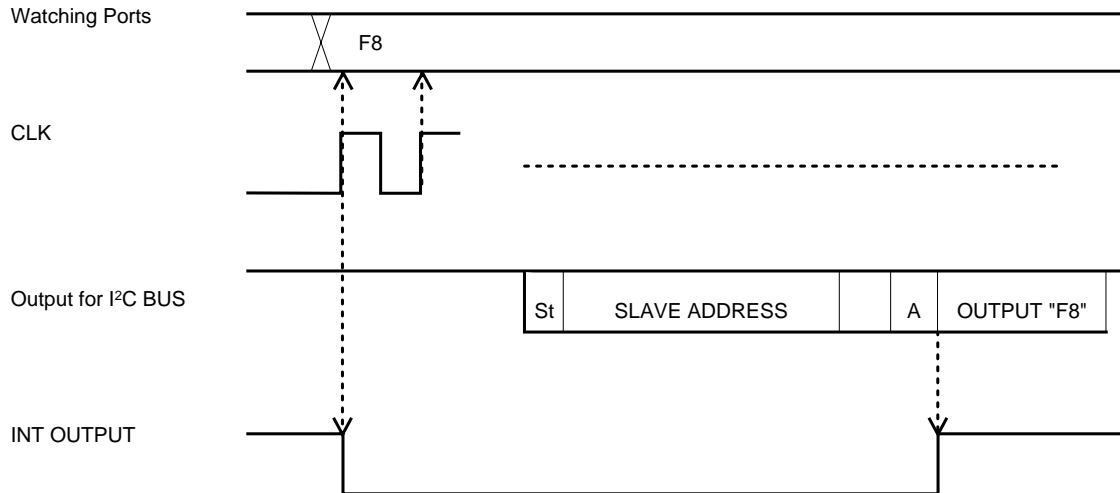

In the case that there is a change in detection ports once, and there are another changes before returning the ACK (as shown "A term"), then watching data is saved. And the output data in this case will be "AND" output of every bits of the watching data.

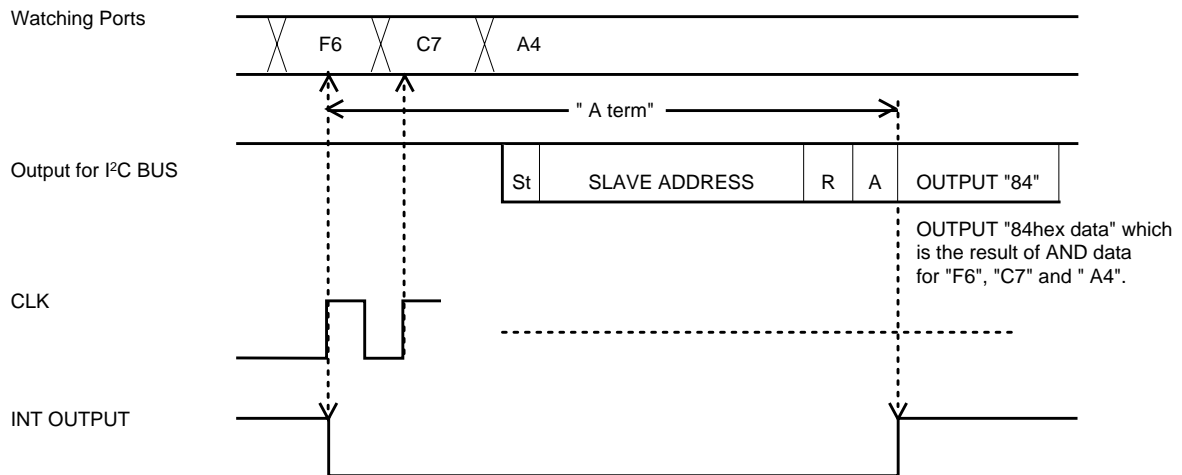

Multimedia ICs

(b) When command D6=1

INT pin outputs "1 clock cycle pulse" when detection of watching port is received. In the case that the output data is the data which is sampled immediately before the returning ACK.

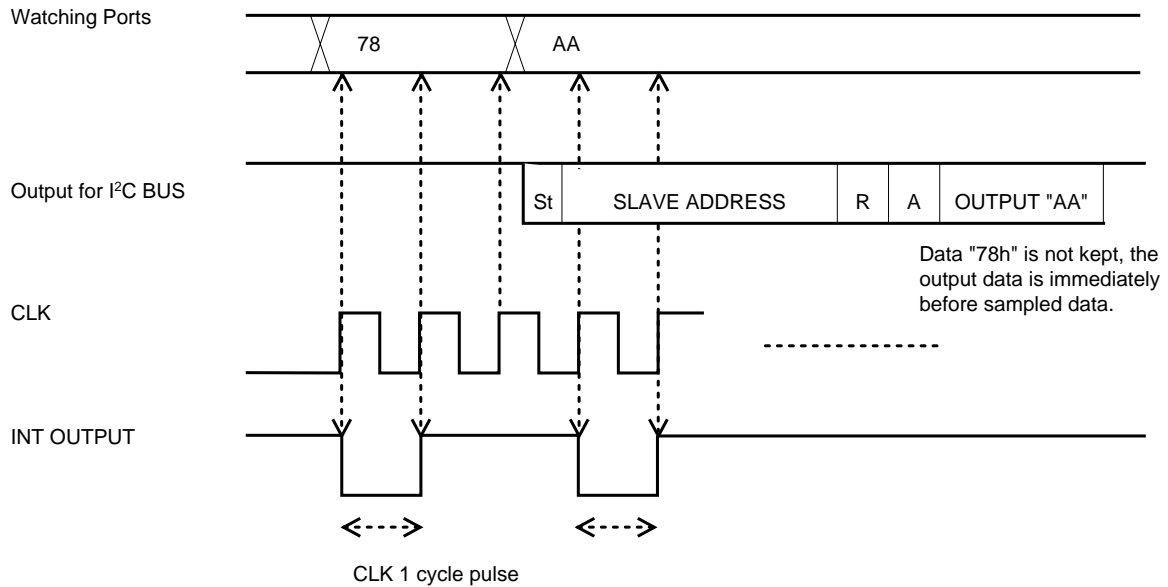

4. Shut down mode

By command D7=1, this IC can be set to Shut down mode, which can save current consumption. At Shut down mode, operation of CLK input pin will be stopped, and input of CLK into this IC can be shut down. Also, for every PIO/PION pins, pins under output condition will be saved as Hi-Z.

At Shut down mode, condition-watching function can not be used.

Contents of each register before shut down will be saved by the shut down release.

●External dimensions (Unit : mm)

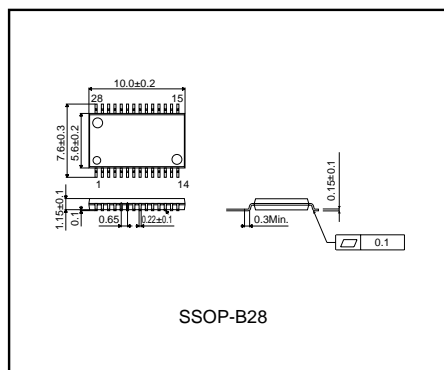

Notes

- No technical content pages of this document may be reproduced in any form or transmitted by any means without prior permission of ROHM CO.,LTD.
- The contents described herein are subject to change without notice. The specifications for the product described in this document are for reference only. Upon actual use, therefore, please request that specifications to be separately delivered.
- Application circuit diagrams and circuit constants contained herein are shown as examples of standard use and operation. Please pay careful attention to the peripheral conditions when designing circuits and deciding upon circuit constants in the set.
- Any data, including, but not limited to application circuit diagrams information, described herein are intended only as illustrations of such devices and not as the specifications for such devices. ROHM CO.,LTD. disclaims any warranty that any use of such devices shall be free from infringement of any third party's intellectual property rights or other proprietary rights, and further, assumes no liability of whatsoever nature in the event of any such infringement, or arising from or connected with or related to the use of such devices.
- Upon the sale of any such devices, other than for buyer's right to use such devices itself, resell or otherwise dispose of the same, no express or implied right or license to practice or commercially exploit any intellectual property rights or other proprietary rights owned or controlled by
- ROHM CO., LTD. is granted to any such buyer.
- Products listed in this document use silicon as a basic material.
Products listed in this document are no antiradiation design.

The products listed in this document are designed to be used with ordinary electronic equipment or devices (such as audio visual equipment, office-automation equipment, communications devices, electrical appliances and electronic toys).

Should you intend to use these products with equipment or devices which require an extremely high level of reliability and the malfunction of which would directly endanger human life (such as medical instruments, transportation equipment, aerospace machinery, nuclear-reactor controllers, fuel controllers and other safety devices), please be sure to consult with our sales representative in advance.

About Export Control Order in Japan

Products described herein are the objects of controlled goods in Annex 1 (Item 16) of Export Trade Control Order in Japan.

In case of export from Japan, please confirm if it applies to "objective" criteria or an "informed" (by MITI clause) on the basis of "catch all controls for Non-Proliferation of Weapons of Mass Destruction.