

# Si photodiode S2386 series

For visible to IR, general-purpose photometry

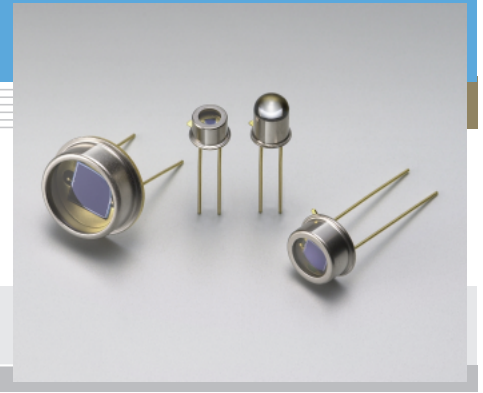

## Features

- High sensitivity
- Low dark current
- High reliability
- High linearity

## Applications

- Analytical equipment
- Optical measurement equipment

### ■ General ratings / Absolute maximum ratings

Type No.	Dimensional outline/ Window material *	Package (mm)	Active area size (mm)	Effective active area (mm <sup>2</sup> )	Absolute maximum ratings		
					Reverse voltage V <sub>R</sub> Max. (V)	Operating temperature T <sub>opr</sub> (°C)	Storage temperature T <sub>stg</sub> (°C)
S2386-18K	①/K	TO-18	1.1 × 1.1	1.2	30	-40 to +100	-55 to +125
S2386-18L	②/L						
S2386-5K	③/K	TO-5	2.4 × 2.4	5.7			
S2386-44K			3.6 × 3.6	13			
S2386-45K			3.9 × 4.6	17.9			
S2386-8K	④/L	TO-8	5.8 × 5.8	33			

### ■ Electrical and optical characteristics (Typ. T<sub>a</sub>=25 °C, unless otherwise noted)

Type No.	Spectral response range λ (nm)	Peak sensitivity wavelength λ <sub>p</sub> (nm)	Photo sensitivity S (A/W)				Short circuit current I <sub>sc</sub> 100 lx		Dark current I <sub>D</sub> V <sub>R</sub> =10 mV Max. (pA)	Temp. coefficient of I <sub>D</sub> T <sub>CID</sub> (times/°C)	Rise time t <sub>r</sub> V <sub>R</sub> =0 V R <sub>L</sub> =1 kΩ (μs)	Terminal capacitance C <sub>t</sub> V <sub>R</sub> =0 V f=10 kHz (pF)	Shunt resistance R <sub>sh</sub> V <sub>R</sub> =10 mV		NEP (W/Hz <sup>1/2</sup> )			
			λ <sub>p</sub>	GaP LED 560 nm	He-Ne laser 633 nm	GaAs LED 930 nm	Min. (μA)	Typ. (μA)					Min.	Typ.				
																(GΩ)	(GΩ)	
S2386-18K	320 to 1100	960	0.6	0.38	0.43	0.59	1	1.3	2	1.12	0.4	140	5	100	6.8 × 10 <sup>-16</sup>			
S2386-18L							4	5.7					2					
S2386-5K							4.4	6.0					5	2		50	9.6 × 10 <sup>-16</sup>	
S2386-44K							9.6	12					20	0.5		25		
S2386-45K							12	17					30	0.3		25		1.4 × 10 <sup>-15</sup>
S2386-8K							26	33					50	0.2		10		

\* Window material K: borosilicate glass, L: lens type borosilicate glass

■ Spectral response

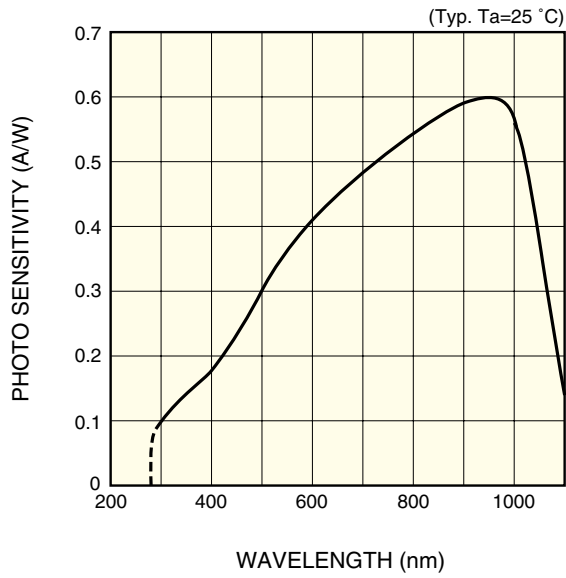

KSPDB0110EA

■ Photo sensitivity temperature characteristic

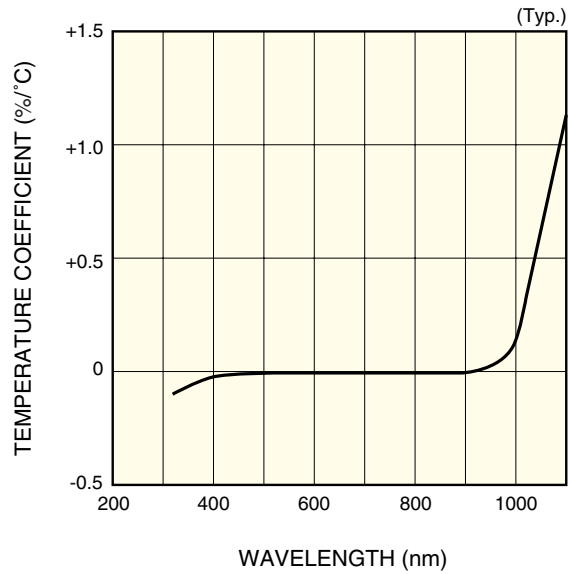

KSPDB0068EB

■ Directivity

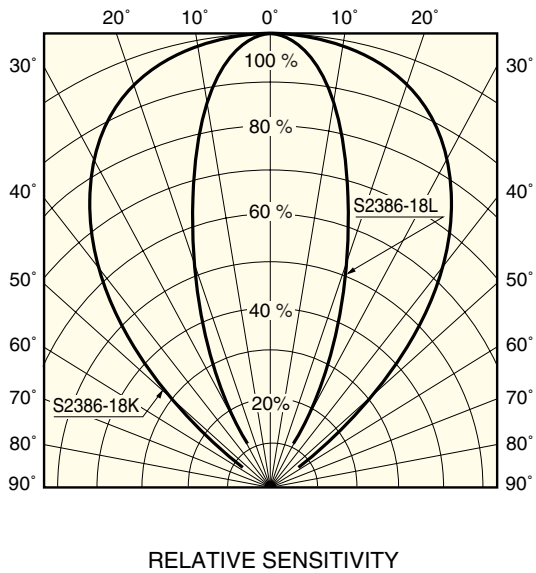

KSPDB0111EA

■ Rise time vs. load resistance

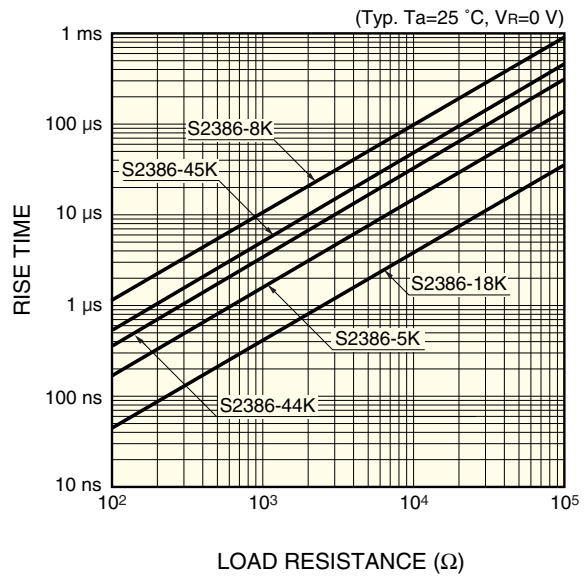

KSPDB0112EA

■ Dark current vs. reverse voltage

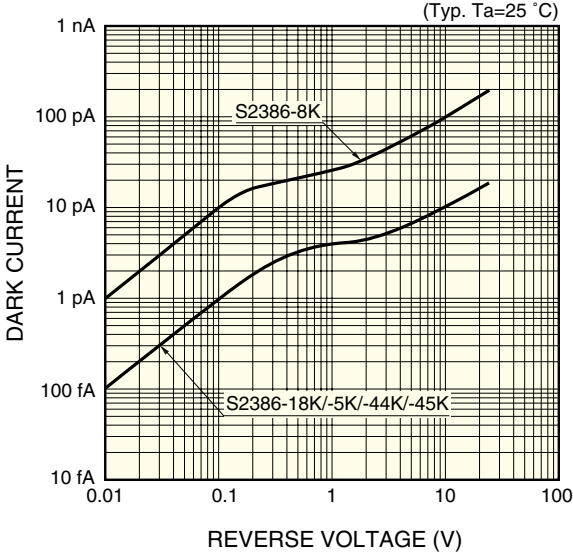

KSPDB0113EA

■ Shunt resistance vs. ambient temperature

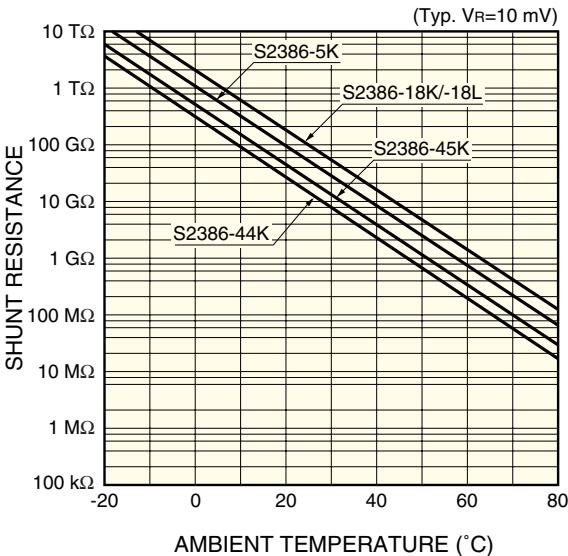

KSPDB0114EA

## Dimensional outlines (unit: mm)

① S2386-18K

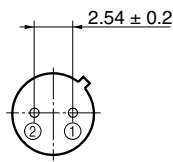
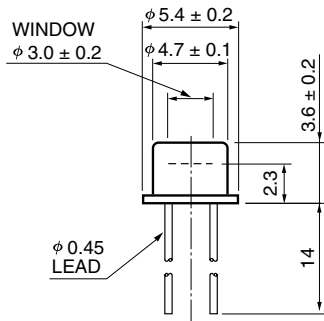

CONNECTED TO CASE

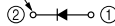

KSPDA0102EB

② S2386-18L

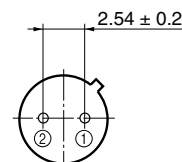
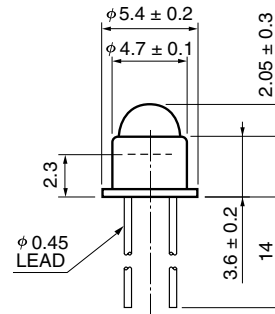

CONNECTED TO CASE



KSPDA0048EB

③ S2386-5K/-44K/-45K

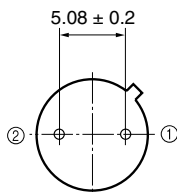
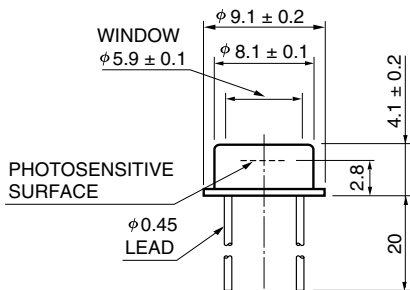

CONNECTED TO CASE

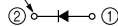

The K type borosilicate glass window may extend a maximum of 0.2 mm above the upper surface of the cap.

KSPDA0103EA

④ S2386-8K

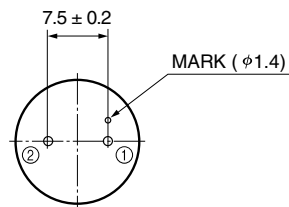
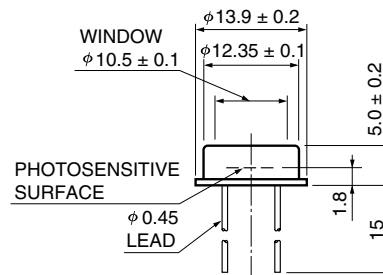

CONNECTED TO CASE

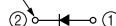

The K type borosilicate glass window may extend a maximum of 0.2 mm above the upper surface of the cap.

KSPDA0104EA

# HAMAMATSU

Information furnished by HAMAMATSU is believed to be reliable. However, no responsibility is assumed for possible inaccuracies or omissions. Specifications are subject to change without notice. No patent rights are granted to any of the circuits described herein. ©2002 Hamamatsu Photonics K.K.

HAMAMATSU PHOTONICS K.K., Solid State Division

1126-1 Ichino-cho, Hamamatsu City, 435-8558 Japan, Telephone: (81) 053-434-3311, Fax: (81) 053-434-5184, <http://www.hamamatsu.com>

U.S.A.: Hamamatsu Corporation: 360 Foothill Road, P.O.Box 6910, Bridgewater, N.J. 08807-0910, U.S.A., Telephone: (1) 908-231-0960, Fax: (1) 908-231-1218

Germany: Hamamatsu Photonics Deutschland GmbH: Arzbergerstr. 10, D-82211 Herrsching am Ammersee, Germany, Telephone: (49) 08152-3750, Fax: (49) 08152-2658

France: Hamamatsu Photonics France S.A.R.L.: 8, Rue du Saule Trapu, Parc du Moulin de Massy, 91882 Massy Cedex, France, Telephone: 33-(1) 69 53 71 00, Fax: 33-(1) 69 53 71 10

United Kingdom: Hamamatsu Photonics UK Limited: 2 Howard Court, 10 Tewin Road, Welwyn Garden City, Hertfordshire AL7 1BW, United Kingdom, Telephone: (44) 1707-294888, Fax: (44) 1707-325777

North Europe: Hamamatsu Photonics Norden AB: Smidesvägen 12, SE-171 41 Solna, Sweden, Telephone: (46) 8-509-031-00, Fax: (46) 8-509-031-01

Italy: Hamamatsu Photonics Italia S.R.L.: Strada della Moia, 1/E, 20020 Arese, (Milano), Italy, Telephone: (39) 02-935-81-733, Fax: (39) 02-935-81-741