

PHASE CONTROL THYRISTORS

Hockey Puk Version

Features

- Double side cooling
- High surge capability
- High mean current
- Fatigue free

Typical Applications

- DC motor controls
- Controlled DC power supplies
- AC controllers

Major Ratings and Characteristics

Parameters	ST2600C..R	Units
$I_{T(AV)}$	2220	A
	@ T_C	80 °C
$I_{T(AV)}$	2630	A
	@ T_{hs}	55 °C
$I_{T(RMS)}$	4800	A
	@ T_{hs}	25 °C
I_{TSM}	@ 50Hz	46000 A
	@ 60Hz	48200 A
i^2t	@ 50Hz	10580 KA ² s
	@ 60Hz	9640 KA ² s
V_{DRM}/V_{RRM}	2000 to 3000	V
t_q	typical	400 μ s
T_J	max.	125 °C

2630A

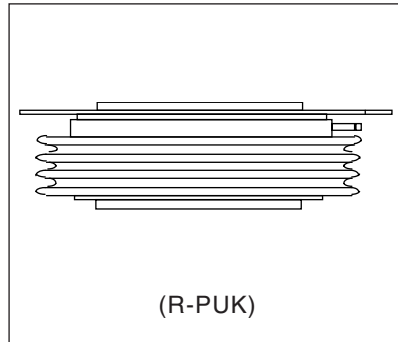

ST2600C..R Series

Bulletin I25199 rev. B 02/00

International
IRF Rectifier

ELECTRICAL SPECIFICATIONS

Voltage Ratings

Type number	Voltage Code	V_{DRM}/V_{RRM} , max. repetitive peak and off-state voltage V	V_{RSM} , maximum non-repetitive peak voltage V	I_{DRM}/I_{RRM} max. @ $T_C = 125^\circ\text{C}$ mA
ST2600C..R	20	2000	2100	250
	22	2200	2300	
	24	2400	2500	
	26	2600	2700	
	28	2800	2900	
	30	3000	3100	

On-state Conduction

Parameter	ST2600C..R	Units	Conditions			
$I_{T(AV)}$ Max. average on-state current @ Case temperature	2220 (1440)	A	180° conduction, half sine wave double side (single side [anode side]) cooled			
	80	°C				
$I_{T(AV)}$ Max. average on-state current @ Heatsink temperature	2630 (1160)	A			DC @ 25°C heatsink temperature double side cooled	
	55 (85)	°C				
$I_{T(RMS)}$ Max. RMS on-state current	4800	A				
I_{TSM} Max. peak, one-cycle non-repetitive surge current	46000	A	t = 10ms	No voltage reappplied		
	48200		t = 8.3ms	50% V_{RRM} reappplied		
	36800		t = 10ms	No voltage reappplied		
	38500		t = 8.3ms	50% V_{RRM} reappplied		
I^2t Maximum I^2t for fusing	10580	KA ² S	t = 10ms	No voltage reappplied		
	9640		t = 8.3ms	50% V_{RRM} reappplied		
	6770		t = 10ms	No voltage reappplied		
	6150		t = 8.3ms	50% V_{RRM} reappplied		
$V_{T(TO)}$ Max. value of threshold voltage	0.89	V	$T_J = T_J$ max.			
r_t Max. value of on-state slope resistance	0.19	mΩ	$T_J = T_J$ max.			
V_{TM} Max. on-state voltage	1.45	V	$I_{pk} = 2900\text{A}$, $T_C = 25^\circ\text{C}$			
I_L Max. (typical) latching current	300 (100)	mA	$T_J = 25^\circ\text{C}$, $V_D = 5\text{V}$			

Switching

Parameter	ST2600C..R	Units	Conditions
di/dt Max. repetitive 50Hz (no repetitive) rate of rise of turned-on current	150 (300)	A/μs	From 67% V_{DRM} gate drive 20V, 20Ω, $t_r = 1\mu\text{s}$ $T_J = T_J$ max.
t_d Maximum delay time	2.0	μs	Gate drive 30V, 15Ω, $V_d = 67\% V_{DRM}$, $T_J = 25^\circ\text{C}$ Rise time 0.5μs
t_q Typical turn-off time	400		$I_T = 800\text{A}$, $t_p = 1\text{ms}$, $T_J = T_J$ max, $V_{RM} = 50\text{V}$, $dI_{FR}/dt = 20\text{A}/\mu\text{s}$, $V_{DR} = 67\% V_{DRM}$, $dV/dt = 20\text{V}/\mu\text{s}$ linear

Blocking

Parameter	ST2600C..R	Units	Conditions
dv/dt Maximum linear rate of rise of off-state voltage	500	V/ μ s	$T_J = T_J$ max. to 67% rated V_{DRM}
I_{RRM} I_{DRM} Max. peak reverse and off-state leakage current	250	mA	$T_J = 125^\circ\text{C}$ rated V_{DRM}/V_{RRM} applied

Triggering

Parameter	ST2600C..R	Units	Conditions
P_{GM} Maximum peak gate power	150	W	$t_p = 100\mu\text{s}$
$P_{G(AV)}$ Maximum average gate power	10		
I_{GM} Max. peak positive gate current	30	A	Anode positive with respect to cathode
V_{GM} Max. peak positive gate voltage	30	V	Anode positive with respect to cathode
$-V_{GM}$ Max. peak negative gate voltage	0.25	V	Anode negative with respect to cathode
I_{GT} Maximum DC gate current required to trigger	400	mA	$T_C = 25^\circ\text{C}$, $V_{DRM} = 5V$
V_{GT} Maximum gate voltage required to trigger	4	V	$T_C = 25^\circ\text{C}$, $V_{DRM} = 5V$
V_{GD} DC gate voltage not to trigger	0.25	V	$T_C = 125^\circ\text{C}$ Max. gate current/voltage not to trigger is the max. value which will not trigger any unit with rated V_{DRM} anode-to-cathode applied

Thermal and Mechanical Specification

Parameter	ST2600C..R	Units	Conditions	
T_J max. Max. operating temperature	125	$^\circ\text{C}$	On-state (conducting)	
T_{stg} Max. storage temperature range	-55 to 125			
R_{thJ-C} Thermal resistance, junction to case	0.019 0.0095	K/W	DC operation single side cooled DC operation double side cooled	
$R_{th(C-h)}$ Thermal resistance, case to heatsink	0.004 0.002	K/W	Single side cooled Double side cooled	Clamping force 43KN with mounting compound
F Mounting force $\pm 10\%$	43000 (4400)	N (Kg)		
wt Approximate weight	1600	g		
Case style	(R-PUK)		See Outline Table	

ΔR_{thJ-C} Conduction

(The following table shows the increment of thermal resistance R_{thJ-C} when devices operate at different conduction angles than DC)

Conduction angle	Single side	Double side	Units	Conditions
180 $^\circ$	0.0010	0.0010	K/W	$T_J = T_J$ max.
120 $^\circ$	0.0017	0.0017		
60 $^\circ$	0.0044	0.0044		

ST2600C..R Series

Bulletin I25199 rev. B 02/00

Ordering Information Table

Device Code							
ST	260	0	C	30	R	1	
①	②	③	④	⑤	⑥	⑦	⑧
1	- Thyristor						
2	- Essential part number						
3	- 0 = Converter grade						
4	- C = Ceramic Puk						
5	- Voltage code: Code x 100 = V_{RRM} (See Voltage Rating Table)						
6	- R = Puk Case						
7	- 0 = Eyelet terminals (Gate and Auxiliary Cathode Unsoldered Leads)						
	- 1 = Fast-on terminals (Gate and Auxiliary Cathode Unsoldered Leads)						
	- 2 = Eyelet terminals (Gate and Auxiliary Cathode Soldered Leads)						
	- 3 = Fast-on terminals (Gate and Auxiliary Cathode Soldered Leads)						
8	- Critical dv/dt: None = 500V/μsec (Standard selection)						
	- L = 1000V/μsec (Special selection)						

Outline Table

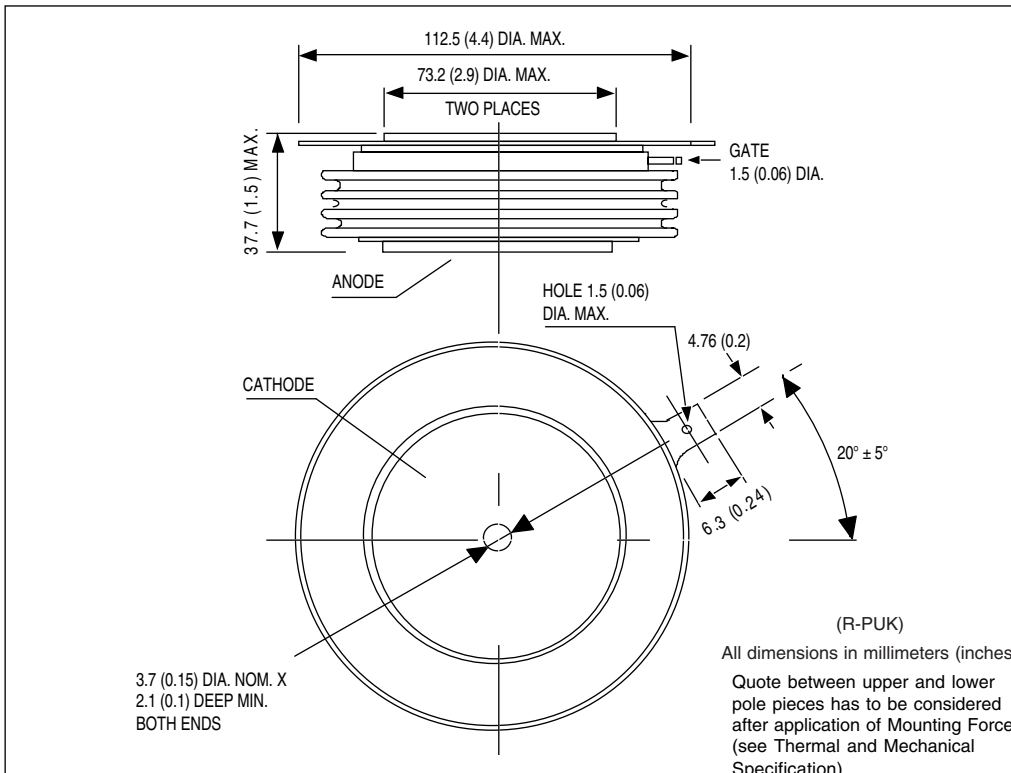

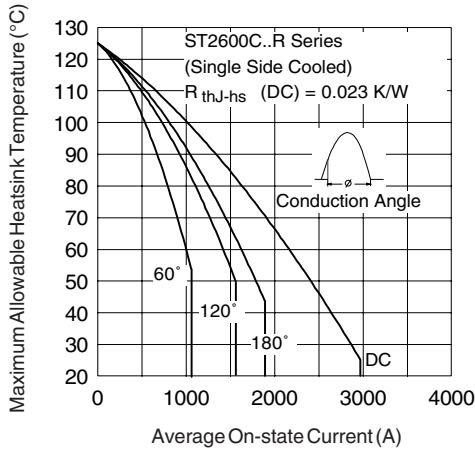

Fig. 1 - Current Ratings Characteristics

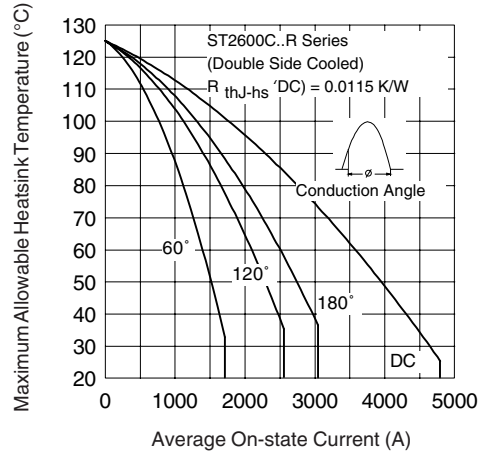

Fig. 2 - Current Ratings Characteristics

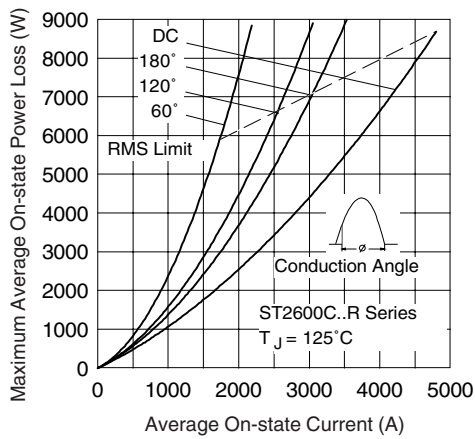

Fig. 3 - On-state Power Loss Characteristics

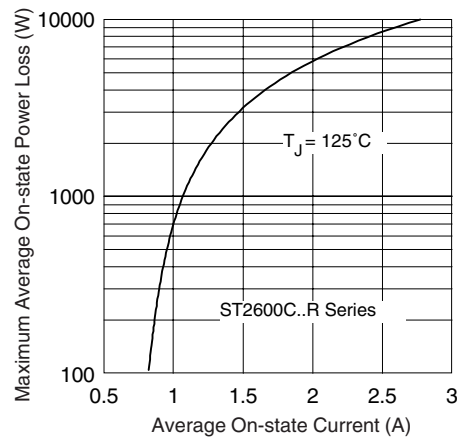

Fig. 4 - On-state Power Loss Characteristics

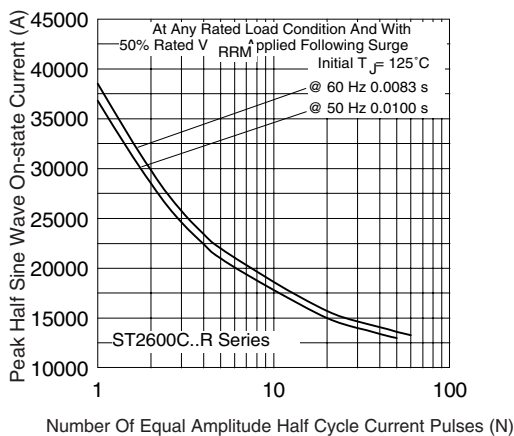

Fig. 5 - Maximum Non-Repetitive Surge Current Single and Double Side Cooled

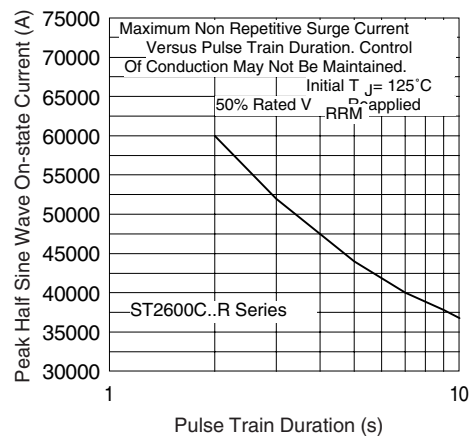

Fig. 6 - Maximum Non-Repetitive Surge Current Single and Double Side Cooled

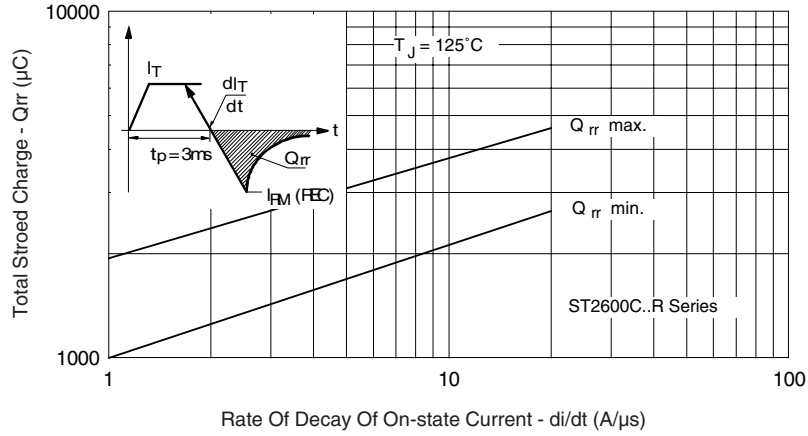

Fig. 7 - Stored Charge

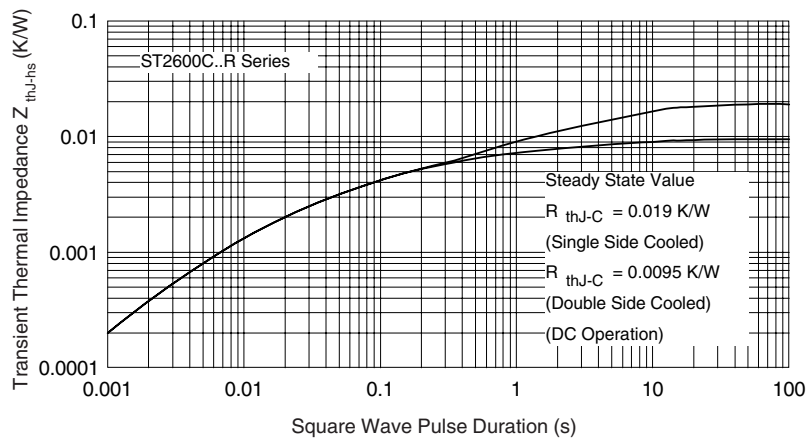

Fig. 10 - Thermal Impedance Z_{thj-hs} Characteristics

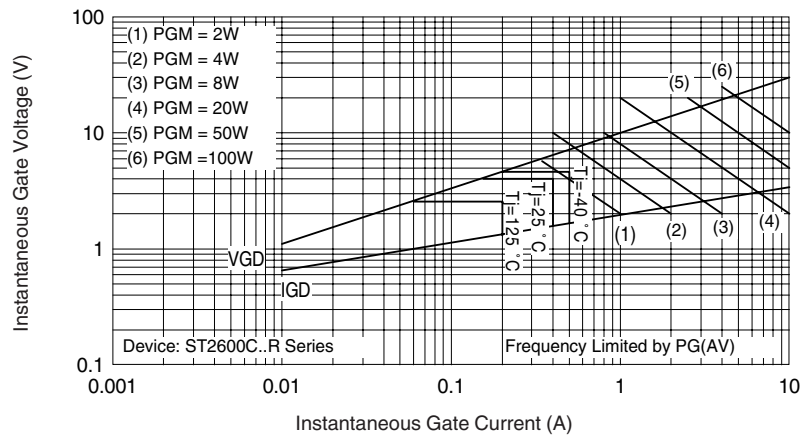

Fig. 11 - Gate Characteristics