

High Voltage Transistors

MAXIMUM RATINGS

Rating	Symbol	2N6515	2N6519	2N6517 2N6520	Unit
Collector–Emitter Voltage	V_{CEO}	250	300	350	Vdc
Collector–Base Voltage	V_{CBO}	250	300	350	Vdc
Emitter–Base Voltage 2N6515, 2N6516, 2N6517 2N6519, 2N6520	V_{EBO}	6.0 5.0			Vdc
Base Current	I_B	250			mAdc
Collector Current — Continuous	I_C	500			mAdc
Total Device Dissipation @ $T_A = 25^\circ\text{C}$ Derate above 25°C	P_D	625 5.0			mW mW/°C
Total Device Dissipation @ $T_C = 25^\circ\text{C}$ Derate above 25°C	P_D	1.5 12			Watts mW/°C
Operating and Storage Junction Temperature Range	T_J, T_{stg}	–55 to +150			°C

THERMAL CHARACTERISTICS

Characteristic	Symbol	Max	Unit
Thermal Resistance, Junction to Ambient	$R_{\theta JA}$	200	°C/W
Thermal Resistance, Junction to Case	$R_{\theta JC}$	83.3	°C/W

NPN
2N6515
2N6517
PNP
2N6519
2N6520

Voltage and current are negative
for PNP transistors

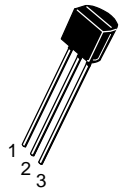

CASE 29–04, STYLE 1
TO–92 (TO–226AA)

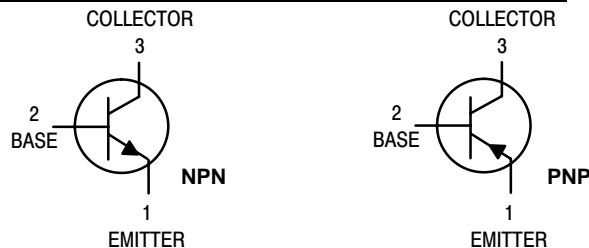

ELECTRICAL CHARACTERISTICS ($T_A = 25^\circ\text{C}$ unless otherwise noted)

Characteristic	Symbol	Min	Max	Unit
----------------	--------	-----	-----	------

OFF CHARACTERISTICS

Collector–Emitter Breakdown Voltage ⁽¹⁾ ($I_C = 1.0 \text{ mAdc}$, $I_B = 0$)	$V_{(BR)CEO}$	250 300 350	— — —	Vdc
Collector–Base Breakdown Voltage ($I_C = 100 \mu\text{Adc}$, $I_E = 0$)	$V_{(BR)CBO}$	250 300 350	— — —	Vdc
Emitter–Base Breakdown Voltage ($I_E = 10 \mu\text{Adc}$, $I_C = 0$)	$V_{(BR)EBO}$	6.0 5.0	— —	Vdc

1. Pulse Test: Pulse Width $\leq 300 \mu\text{s}$, Duty Cycle $\leq 2.0\%$.

NPN 2N6515 2N6517 PNP 2N6519 2N6520

ELECTRICAL CHARACTERISTICS ($T_A = 25^\circ\text{C}$ unless otherwise noted) (Continued)

Characteristic	Symbol	Min	Max	Unit
OFF CHARACTERISTICS (Continued)				
Collector Cutoff Current ($V_{CB} = 150\text{ Vdc}$, $I_E = 0$) ($V_{CB} = 200\text{ Vdc}$, $I_E = 0$) ($V_{CB} = 250\text{ Vdc}$, $I_E = 0$)	I_{CBO}	—	50	nAdc
			50	
			50	
Emitter Cutoff Current ($V_{EB} = 5.0\text{ Vdc}$, $I_C = 0$) ($V_{EB} = 4.0\text{ Vdc}$, $I_C = 0$)	I_{EBO}	—	50	nAdc
			50	

ON CHARACTERISTICS⁽¹⁾

DC Current Gain ($I_C = 1.0\text{ mAdc}$, $V_{CE} = 10\text{ Vdc}$)	h_{FE}	35	—	—
		30	—	
		20	—	
($I_C = 10\text{ mAdc}$, $V_{CE} = 10\text{ Vdc}$)		50	—	
		45	—	
		30	—	
($I_C = 30\text{ mAdc}$, $V_{CE} = 10\text{ Vdc}$)		50	300	
		45	270	
		30	200	
($I_C = 50\text{ mAdc}$, $V_{CE} = 10\text{ Vdc}$)		45	220	
		40	200	
		20	200	
($I_C = 100\text{ mAdc}$, $V_{CE} = 10\text{ Vdc}$)		25	—	
		20	—	
		15	—	
Collector–Emitter Saturation Voltage ($I_C = 10\text{ mAdc}$, $I_B = 1.0\text{ mAdc}$) ($I_C = 20\text{ mAdc}$, $I_B = 2.0\text{ mAdc}$) ($I_C = 30\text{ mAdc}$, $I_B = 3.0\text{ mAdc}$) ($I_C = 50\text{ mAdc}$, $I_B = 5.0\text{ mAdc}$)	$V_{CE(sat)}$	—	0.30	Vdc
			0.35	
			0.50	
			1.0	
Base–Emitter Saturation Voltage ($I_C = 10\text{ mAdc}$, $I_B = 1.0\text{ mAdc}$) ($I_C = 20\text{ mAdc}$, $I_B = 2.0\text{ mAdc}$) ($I_C = 30\text{ mAdc}$, $I_B = 3.0\text{ mAdc}$)	$V_{BE(sat)}$	—	0.75	Vdc
			0.85	
			0.90	
Base–Emitter On Voltage ($I_C = 100\text{ mAdc}$, $V_{CE} = 10\text{ Vdc}$)	$V_{BE(on)}$	—	2.0	Vdc

SMALL–SIGNAL CHARACTERISTICS

Current–Gain — Bandwidth Product ⁽¹⁾ ($I_C = 10\text{ mAdc}$, $V_{CE} = 20\text{ Vdc}$, $f = 20\text{ MHz}$)	f_T	40	200	MHz
Collector–Base Capacitance ($V_{CB} = 20\text{ Vdc}$, $I_E = 0$, $f = 1.0\text{ MHz}$)	C_{cb}	—	6.0	pF
Emitter–Base Capacitance ($V_{EB} = 0.5\text{ Vdc}$, $I_C = 0$, $f = 1.0\text{ MHz}$)	C_{eb}	—	80	pF
			100	

SWITCHING CHARACTERISTICS

Turn–On Time ($V_{CC} = 100\text{ Vdc}$, $V_{BE(off)} = 2.0\text{ Vdc}$, $I_C = 50\text{ mAdc}$, $I_{B1} = 10\text{ mAdc}$)	t_{on}	—	200	μs
Turn–Off Time ($V_{CC} = 100\text{ Vdc}$, $I_C = 50\text{ mAdc}$, $I_{B1} = I_{B2} = 10\text{ mAdc}$)	t_{off}	—	3.5	μs

1. Pulse Test: Pulse Width $\leq 300\ \mu\text{s}$, Duty Cycle $\leq 2.0\%$.

NPN 2N6515 2N6517 PNP 2N6519 2N6520

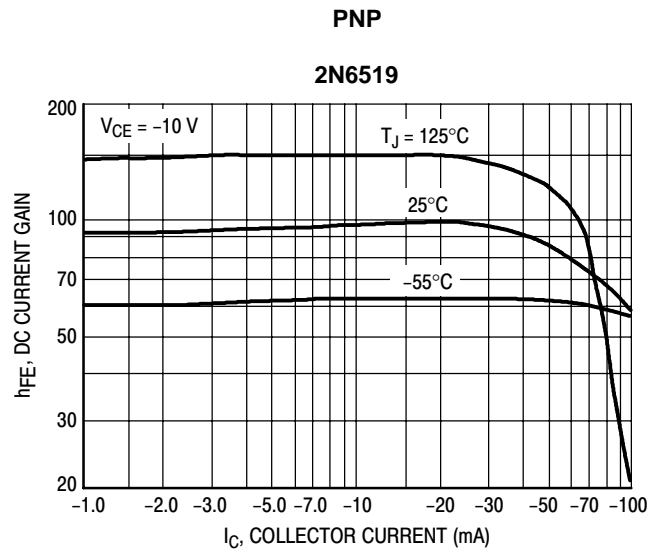
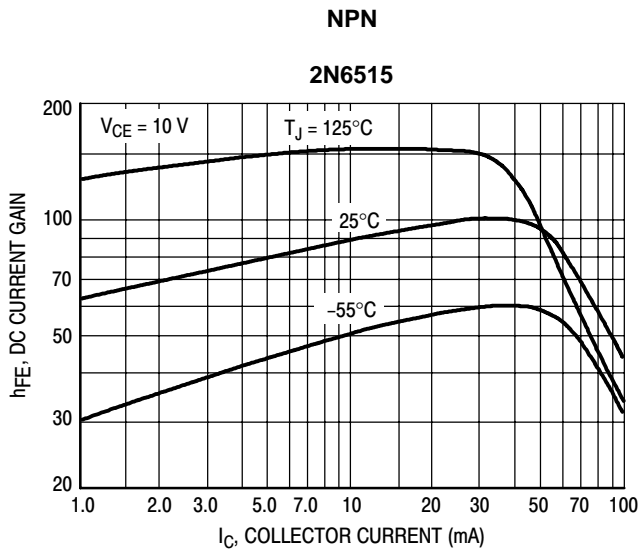

Figure 1. DC Current Gain

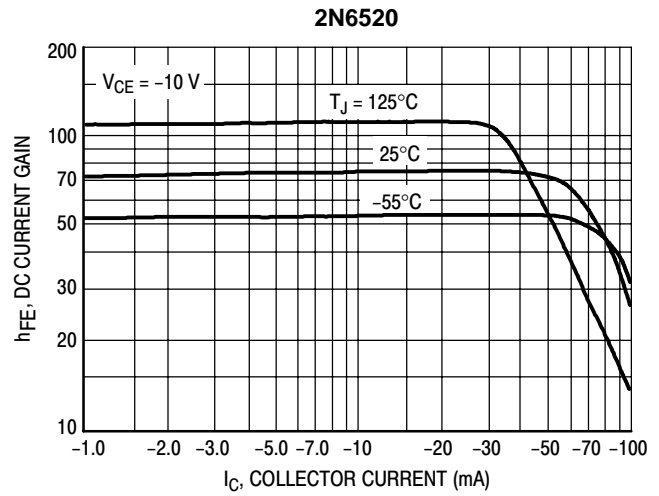
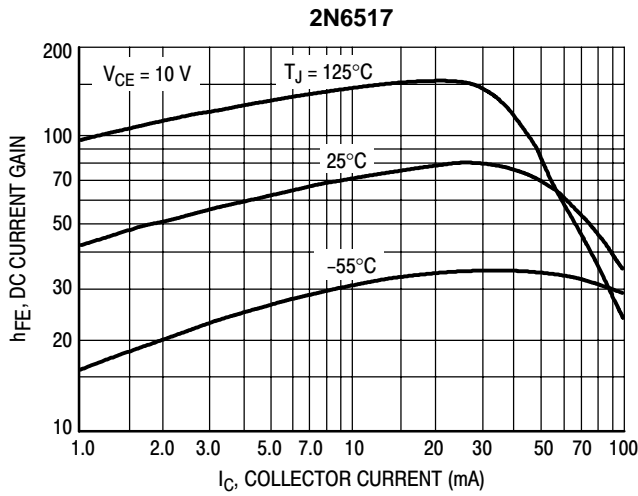

Figure 2. DC Current Gain

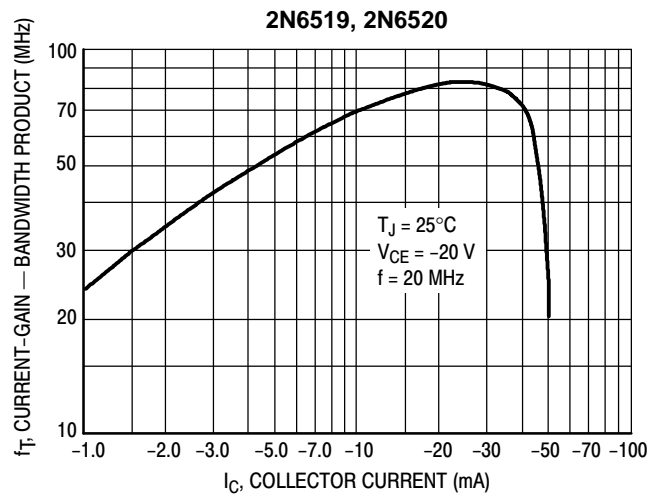
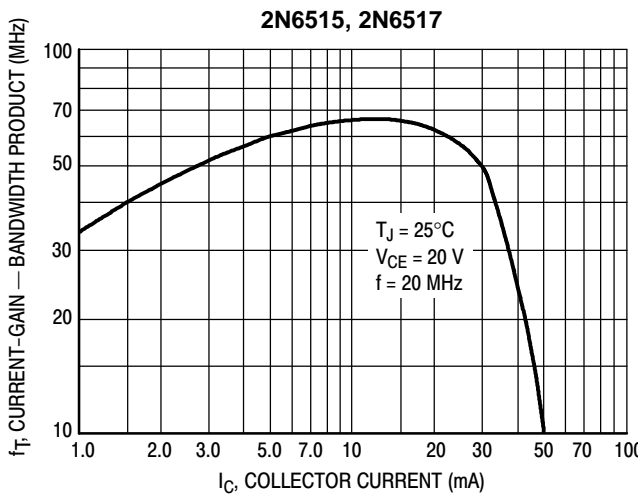

Figure 3. Current-Gain — Bandwidth Product

NPN 2N6515 2N6517 PNP 2N6519 2N6520

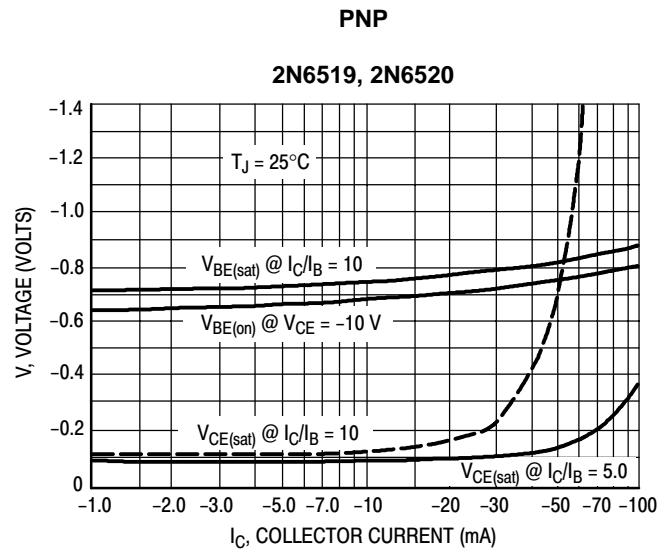
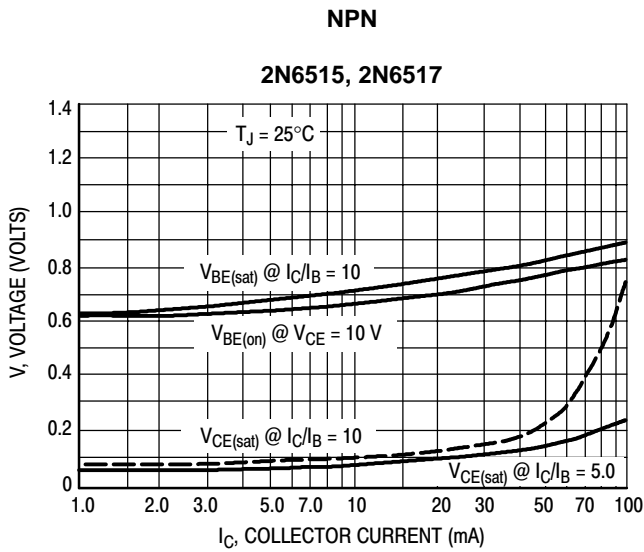

Figure 4. "On" Voltages

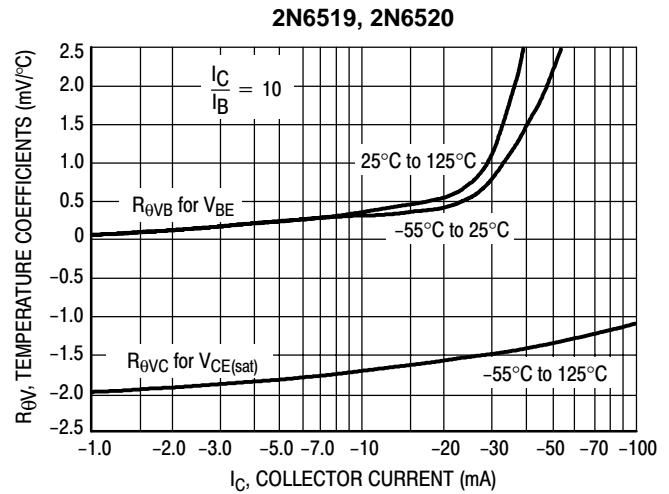
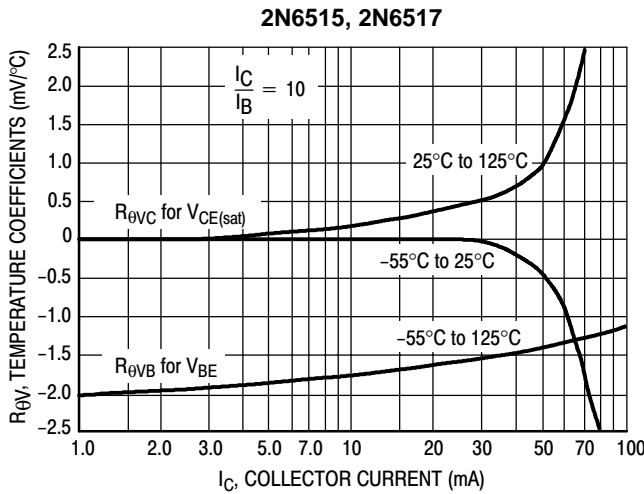

Figure 5. Temperature Coefficients

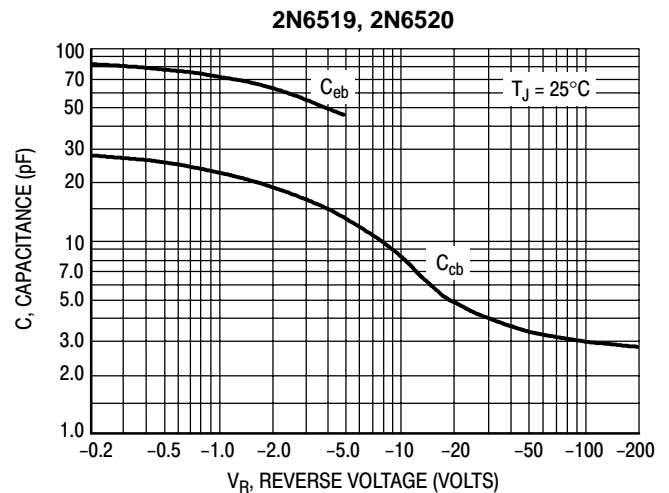
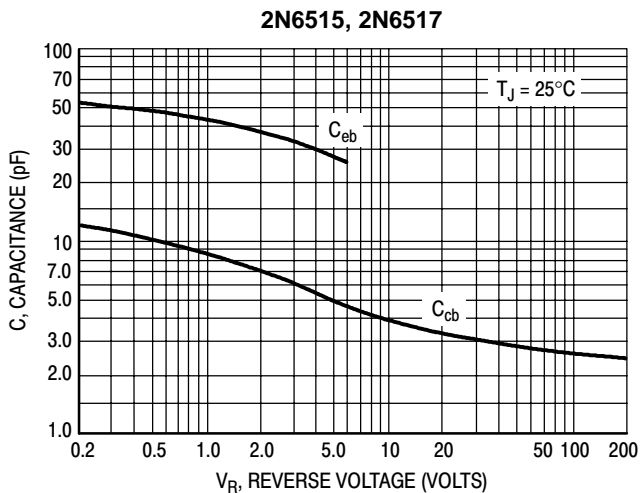

Figure 6. Capacitance

NPN 2N6515 2N6517 PNP 2N6519 2N6520

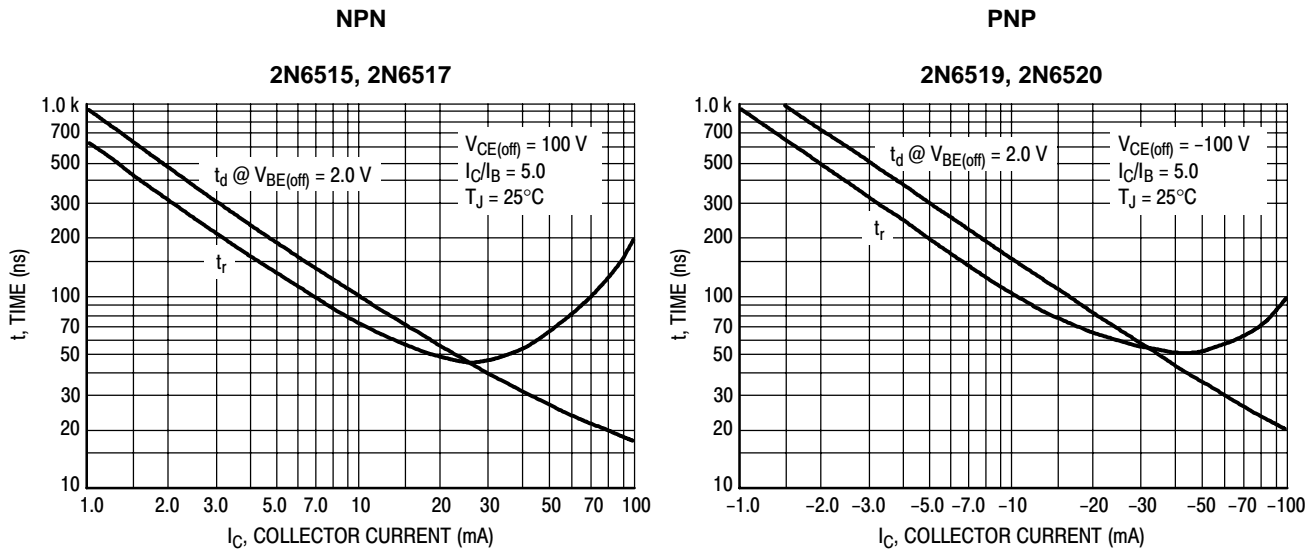

Figure 7. Turn-On Time

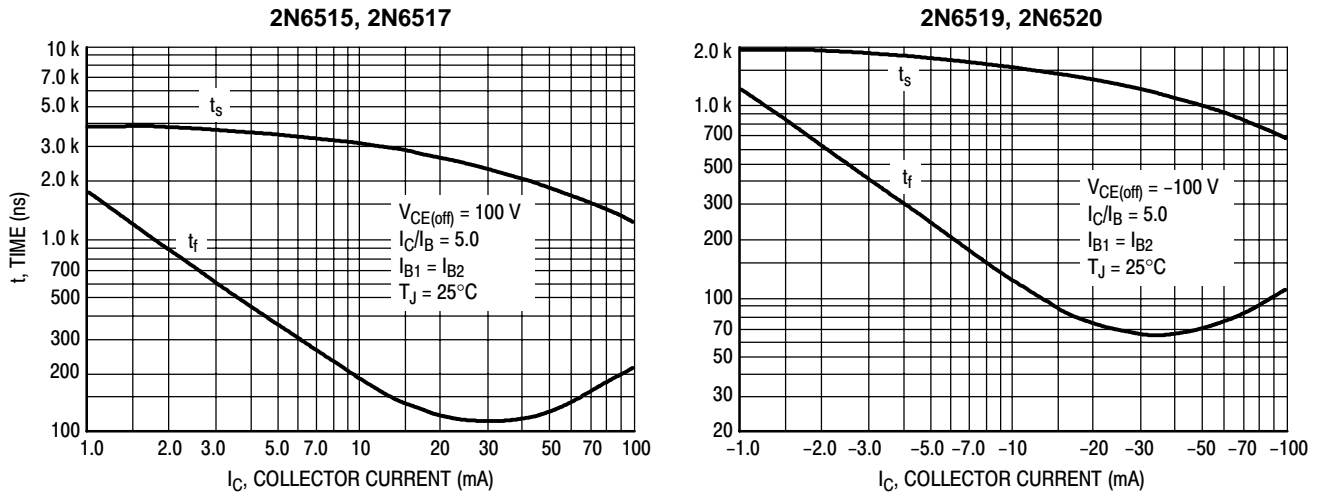

Figure 8. Turn-Off Time

NPN 2N6515 2N6517 PNP 2N6519 2N6520

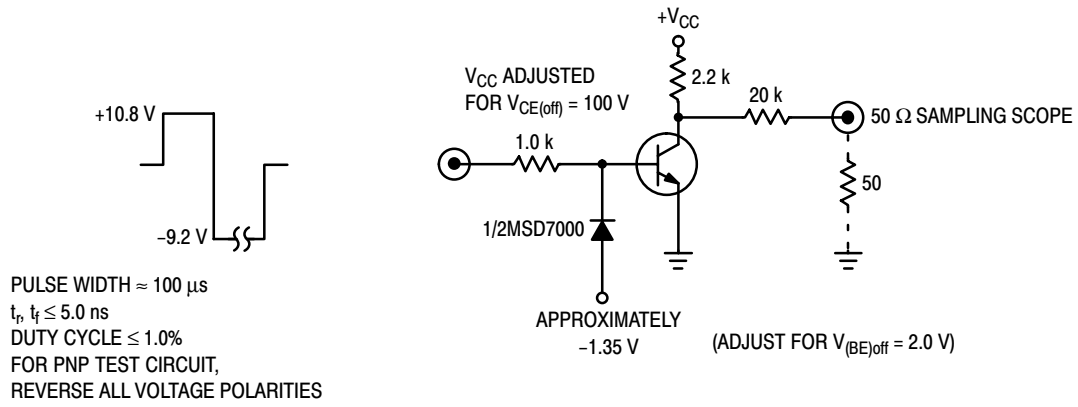

Figure 9. Switching Time Test Circuit

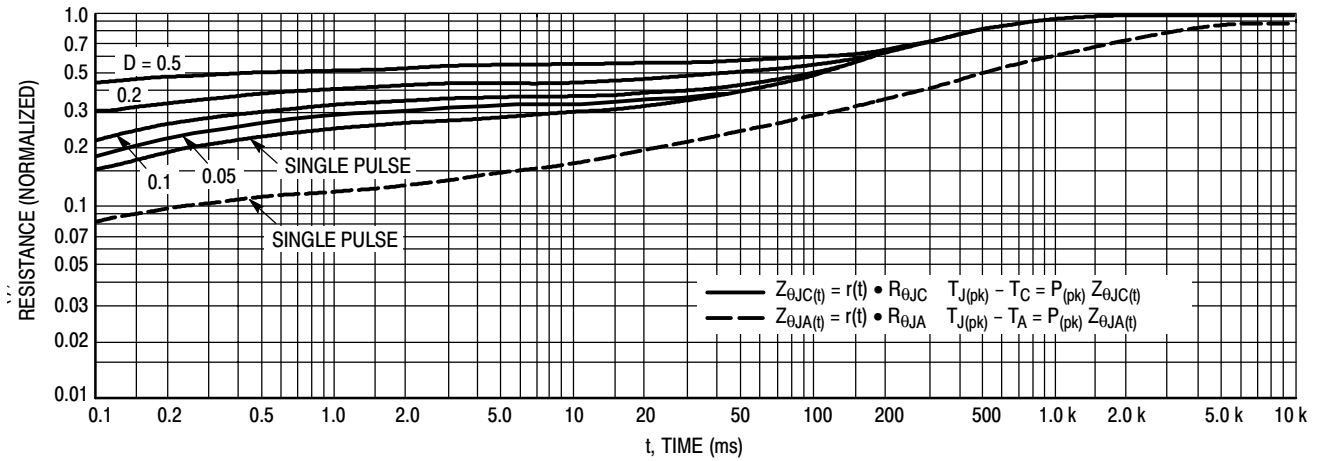

Figure 10. Thermal Response

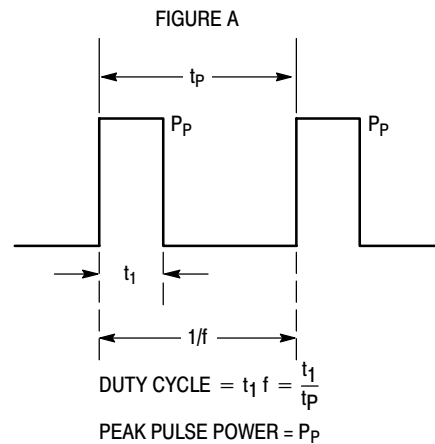
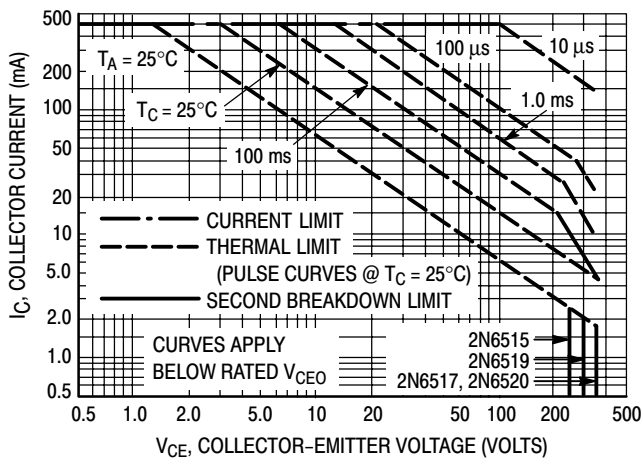

Figure 11. Active Region Safe Operating Area

Design Note: Use of Transient Thermal Resistance Data

PACKAGE DIMENSIONS

NPN 2N6515 2N6517 PNP 2N6519 2N6520

CASE 029-04
(TO-226AA)
ISSUE AD

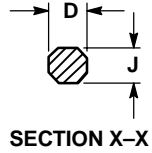
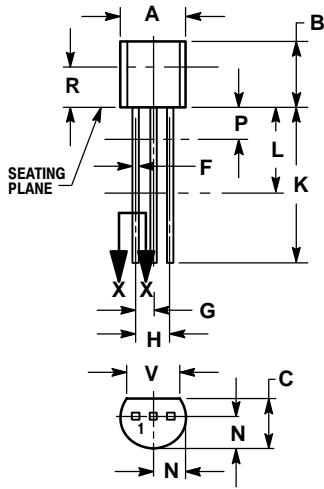

NOTES:

1. DIMENSIONING AND TOLERANCING PER ANSI Y14.5M, 1982.
2. CONTROLLING DIMENSION: INCH.
3. CONTOUR OF PACKAGE BEYOND DIMENSION R IS UNCONTROLLED.
4. DIMENSION F APPLIES BETWEEN P AND L. DIMENSION D AND J APPLY BETWEEN L AND K. MINIMUM LEAD DIMENSION IS UNCONTROLLED IN P AND BEYOND DIMENSION K MINIMUM.

DIM	INCHES		MILLIMETERS	
	MIN	MAX	MIN	MAX
A	0.175	0.205	4.45	5.20
B	0.170	0.210	4.32	5.33
C	0.125	0.165	3.18	4.19
D	0.016	0.022	0.41	0.55
F	0.016	0.019	0.41	0.48
G	0.045	0.055	1.15	1.39
H	0.095	0.105	2.42	2.66
J	0.015	0.020	0.39	0.50
K	0.500	---	12.70	---
L	0.250	---	6.35	---
N	0.080	0.105	2.04	2.66
P	---	0.100	---	2.54
R	0.115	---	2.93	---
V	0.135	---	3.43	---

STYLE 1:

- PIN 1. EMITTER
2. BASE
3. COLLECTOR

ON Semiconductor and  are trademarks of Semiconductor Components Industries, LLC (SCILLC). SCILLC reserves the right to make changes without further notice to any products herein. SCILLC makes no warranty, representation or guarantee regarding the suitability of its products for any particular purpose, nor does SCILLC assume any liability arising out of the application or use of any product or circuit, and specifically disclaims any and all liability, including without limitation special, consequential or incidental damages. "Typical" parameters which may be provided in SCILLC data sheets and/or specifications can and do vary in different applications and actual performance may vary over time. All operating parameters, including "Typicals" must be validated for each customer application by customer's technical experts. SCILLC does not convey any license under its patent rights nor the rights of others. SCILLC products are not designed, intended, or authorized for use as components in systems intended for surgical implant into the body, or other applications intended to support or sustain life, or for any other application in which the failure of the SCILLC product could create a situation where personal injury or death may occur. Should Buyer purchase or use SCILLC products for any such unintended or unauthorized application, Buyer shall indemnify and hold SCILLC and its officers, employees, subsidiaries, affiliates, and distributors harmless against all claims, costs, damages, and expenses, and reasonable attorney fees arising out of, directly or indirectly, any claim of personal injury or death associated with such unintended or unauthorized use, even if such claim alleges that SCILLC was negligent regarding the design or manufacture of the part. SCILLC is an Equal Opportunity/Affirmative Action Employer.

PUBLICATION ORDERING INFORMATION

NORTH AMERICA Literature Fulfillment:

Literature Distribution Center for ON Semiconductor
P.O. Box 5163, Denver, Colorado 80217 USA
Phone: 303-675-2175 or 800-344-3860 Toll Free USA/Canada
Fax: 303-675-2176 or 800-344-3867 Toll Free USA/Canada
Email: ONlit@hibbertco.com
Fax Response Line: 303-675-2167 or 800-344-3810 Toll Free USA/Canada

N. American Technical Support: 800-282-9855 Toll Free USA/Canada

EUROPE: LDC for ON Semiconductor – European Support

German Phone: (+1) 303-308-7140 (Mon-Fri 2:30pm to 7:00pm CET)
Email: ONlit-german@hibbertco.com
French Phone: (+1) 303-308-7141 (Mon-Fri 2:00pm to 7:00pm CET)
Email: ONlit-french@hibbertco.com
English Phone: (+1) 303-308-7142 (Mon-Fri 12:00pm to 5:00pm GMT)
Email: ONlit@hibbertco.com

EUROPEAN TOLL-FREE ACCESS*: 00-800-4422-3781

*Available from Germany, France, Italy, UK, Ireland

CENTRAL/SOUTH AMERICA:

Spanish Phone: 303-308-7143 (Mon-Fri 8:00am to 5:00pm MST)
Email: ONlit-spanish@hibbertco.com
Toll-Free from Mexico: Dial 01-800-288-2872 for Access –
then Dial 866-297-9322

ASIA/PACIFIC: LDC for ON Semiconductor – Asia Support

Phone: 303-675-2121 (Tue-Fri 9:00am to 1:00pm, Hong Kong Time)
Toll Free from Hong Kong & Singapore:
001-800-4422-3781
Email: ONlit-asia@hibbertco.com

JAPAN: ON Semiconductor, Japan Customer Focus Center

4-32-1 Nishi-Gotanda, Shinagawa-ku, Tokyo, Japan 141-0031
Phone: 81-3-5740-2700
Email: r14525@onsemi.com

ON Semiconductor Website: <http://onsemi.com>

For additional information, please contact your local Sales Representative.