

# SPECIFICATION

DEVICE NAME : Power MOSFET

TYPE NAME : 2SK2771-01R

SPEC. No. :

Fuji Electric Co.,Ltd.

This Specification is subject to change without notice.

	DATE	NAME	APPROVED	Fuji Electric Co.,Ltd.	
DRAWN				DWG.NO.	1/11
CHECKED					

1. Scope  
This specifies Fuji power MOSFET 2SK2771-01R
2. Construction N-channel enhancement mode power MOSFET
3. Application for switching
4. Outview TO-3PF Outview See to 5/11 page
5. Absolute maximum ratings at  $T_c=25^\circ\text{C}$  (unless otherwise specified)

Description	Symbol	Characteristics	Unit	Remarks
Drain-source voltage	$V_{DS}$	900	V	
Drain-gate voltage	$V_{DGR}$	900	V	$R_{GS} = 20\text{K}\Omega$
Continuous Drain current	$I_D$	$\pm 9$	A	
Pulsed drain current	$I_{Dpulsec}$	$\pm 36$	A	
Gate-source voltage	$V_{GS}$	$\pm 30$	V	
Maximum power dissipation	$P_D$	100	W	
Operating and storage temperature range	$T_{ch}$	150	$^\circ\text{C}$	
	$T_{sto}$	-55 ~ +150	$^\circ\text{C}$	

6. Electrical characteristics at  $T_c=25^\circ\text{C}$  (unless otherwise specified)

Description	Symbol	Conditions	Characteristics			Unit
			Min.	Typ.	Max.	
Drain-source breakdown voltage	$BV_{DSS}$	$I_D = 1\text{mA}$ $V_{GS} = 0\text{V}$	900			V
Gate threshold voltage	$V_{GS(th)}$	$I_D = 1\text{mA}$ $V_{DS} = V_{GS}$	2.5	3.0	3.5	V
Zero gate voltage drain current	$I_{DSS}$	$V_{DS} = 900\text{V}$ $V_{GS} = 0\text{V}$	$T_{ch} = 25^\circ\text{C}$	10	500	$\mu\text{A}$
	$I_{DSS}$		$T_{ch} = 125^\circ\text{C}$	0.2	1.0	mA
Gate-source leakage current	$I_{GSS}$	$V_{GS} = \pm 30\text{V}$ $V_{DS} = 0\text{V}$		10	100	nA
Drain-source on-state resistance	$R_{DS(on)}$	$I_D = 4.5\text{A}$ $V_{GS} = 10\text{V}$		1.1	1.4	$\Omega$

Fuji Electric Co., Ltd.

DWG. NO.

2/11

Y 0257-R-003a

Dynamic ratings

Description	Symbol	Conditions	Characteristics			Unit
			Min.	Typ.	Max.	
Forward transconductance	$g_{fs}$	$I_D = 4.5A$ $V_{DS} = 25V$	5	10		S
Input capacitance	$C_{iss}$	$V_{DS} = 25V$ $V_{GS} = 0V$ $f = 1MHz$		2200	3300	pF
Output capacitance	$C_{oss}$			210	320	pF
Reverse transfer capacitance	$C_{rss}$			65	100	pF
Turn-on time	$t_{d(on)}$	$V_{CC} = 600V$ $V_{GS} = 10V$ $I_D = 9A$ $R_{GS} = 10\Omega$		25	40	ns
	$t_r$			60	90	ns
Turn-off time	$t_{d(off)}$			140	210	ns
	$t_f$			70	110	ns

Reverse diode

Description	Symbol	Conditions	Characteristics			Unit
			Min.	Typ.	Max.	
Avalanche capability	$I_{AV}$	$L = 100\mu H$ , $T_{ch} = 25^\circ C$ * see Fig1 and Fig2	9			A
Diode forward on-voltage	$V_{SD}$	$I_F = 2 \times I_{DR}$ $V_{GS} = 0V$ , $T_{ch} = 25^\circ C$		1.2	1.8	V
Reverse recovery time	$t_{rr}$	$I_F = I_{DR}$ $V_{GS} = 0V$ $-di_F/dt = 100A/\mu s$ $T_{ch} = 25^\circ C$		450		ns
Reverse recovery charge	$Q_{rr}$			4		$\mu C$

7. Thermal resistance

Description	Symbol	Conditions	Characteristics			Unit
			Min.	Typ.	Max.	
Thermal resistance	$R_{th_{ch-c}}$				1.25	$^\circ C/W$
	$R_{th_{ch-a}}$				30.0	$^\circ C/W$

Fig.1 Test circuit

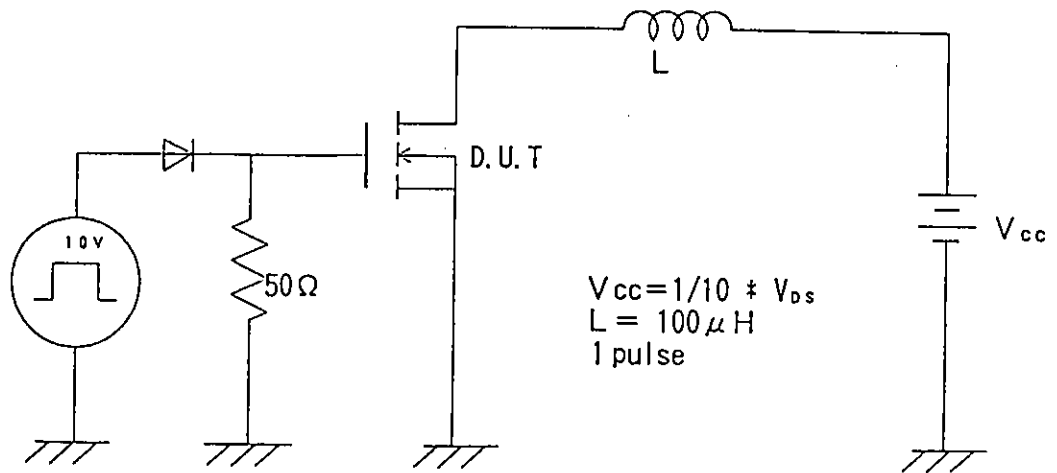
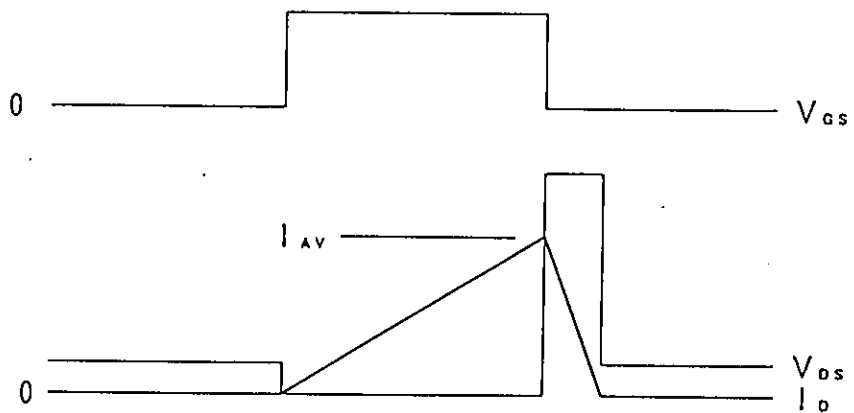
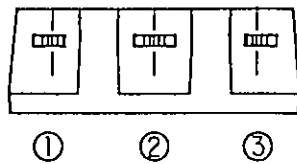
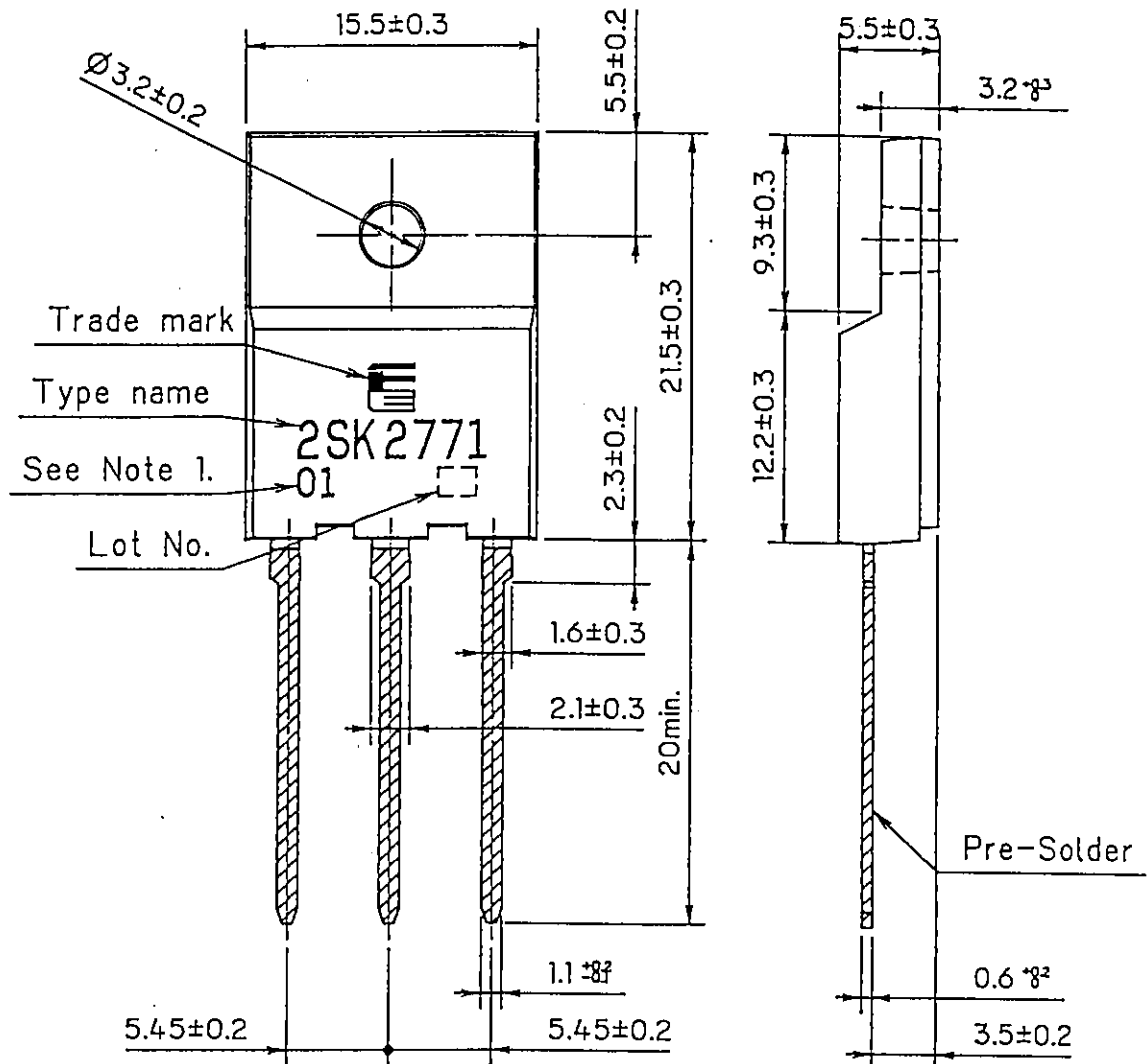

Fig.2 Operating waveforms



FUJI POWER MOSFET

TYPE : 2SK2771-01R



CONNECTION

- ① GATE
- ② DRAIN
- ③ SOURCE

Note 1. Guaranteed mark of avalanche ruggedness.

DIMENSIONS ARE IN MILLIMETERS.

Fuji Electric Co., Ltd.

DWG. NO.

5/11

Y 0257-R-003a

Power Dissipation  
 $PD=f(T_c)$

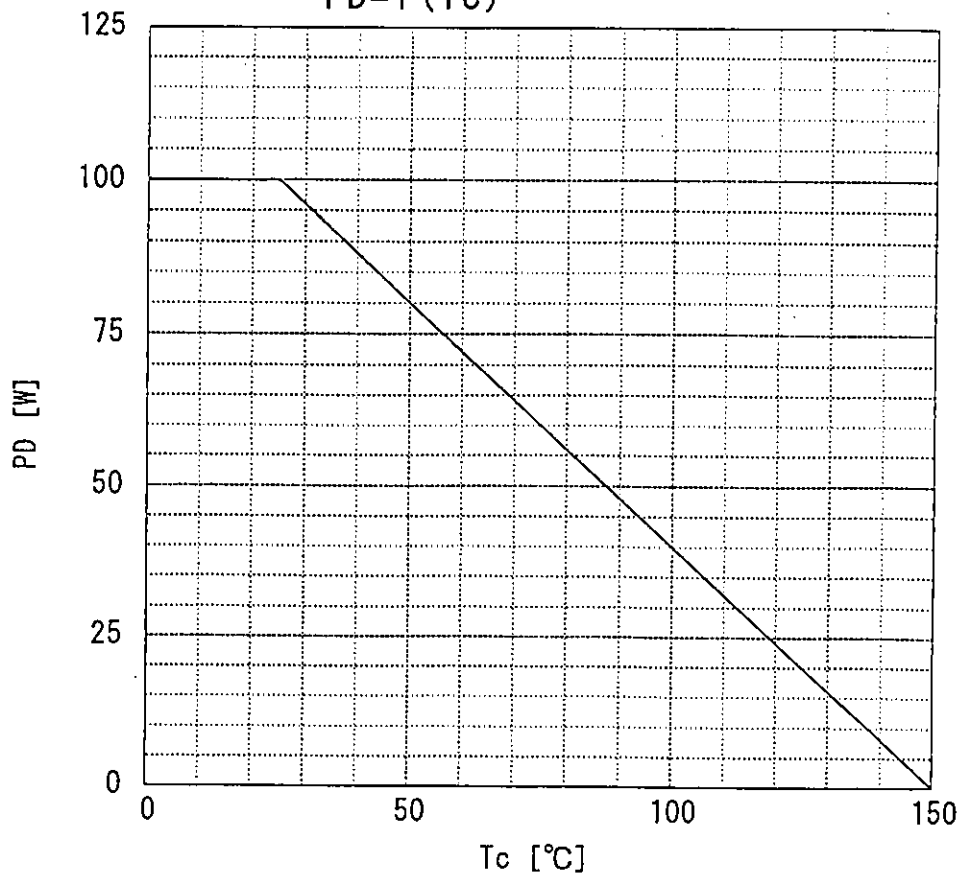

Safe operating area  
 $ID=f(V_{DS}) : D=0.01, T_c=25^\circ\text{C}$

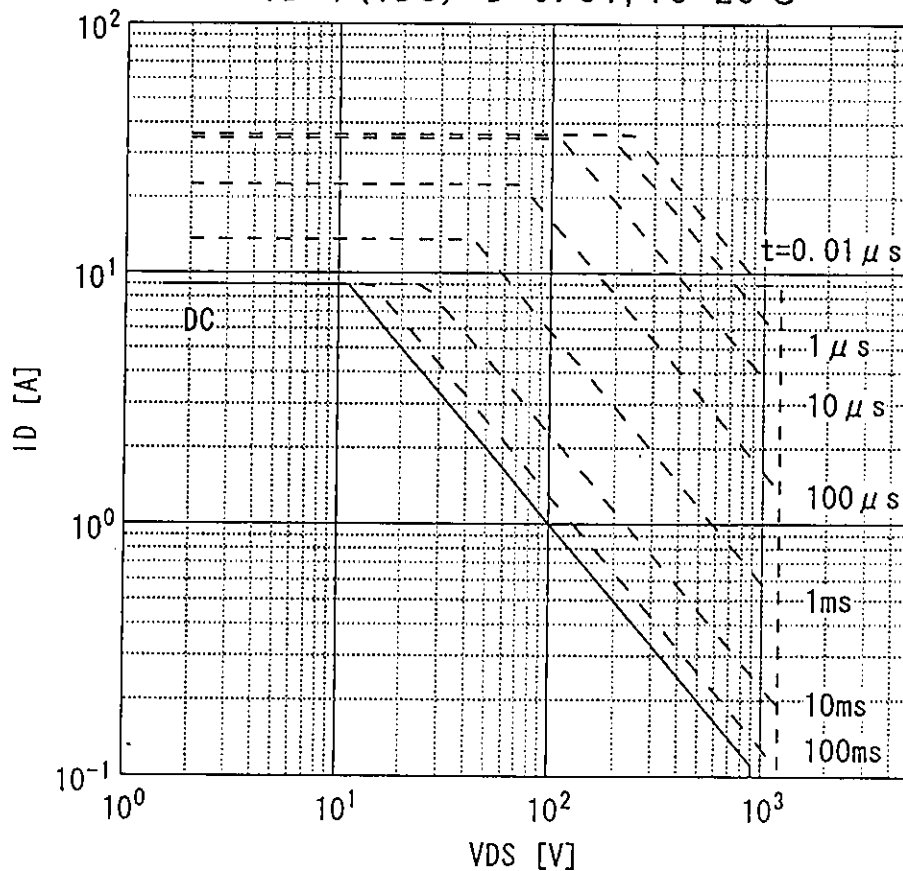

Typical output characteristics  
 $I_D = f(V_{DS})$ :  $80 \mu s$  pulse test,  $T_{ch} = 25^\circ C$

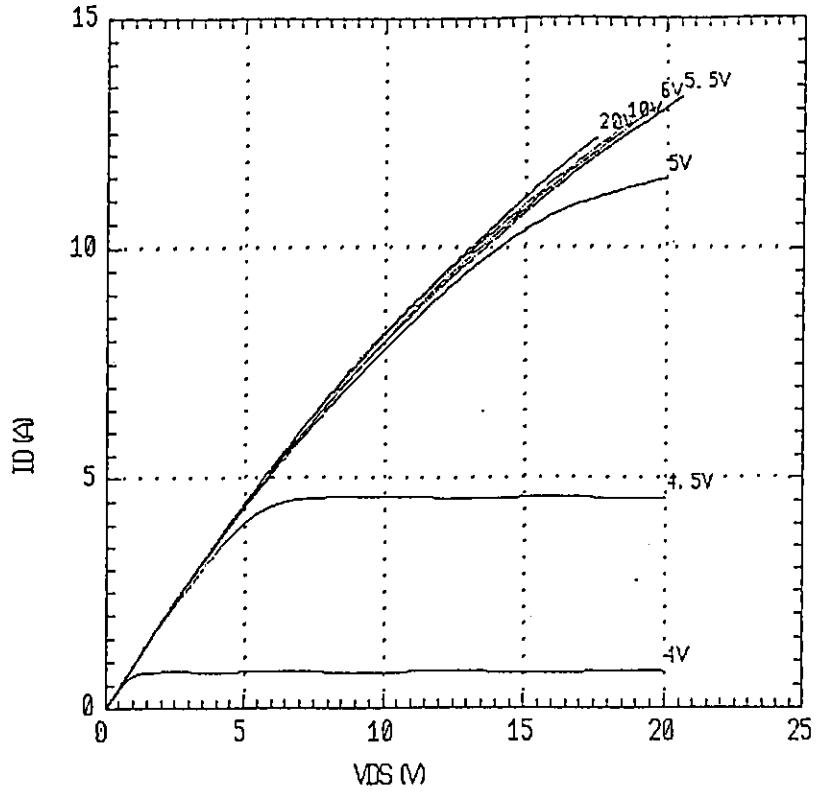

Typical Transfer Characteristics  
 $I_D = f(V_{GS})$ :  $80 \mu s$  pulse test,  $V_{DS} = 25V$ ,  $T_{ch} = 25^\circ C$

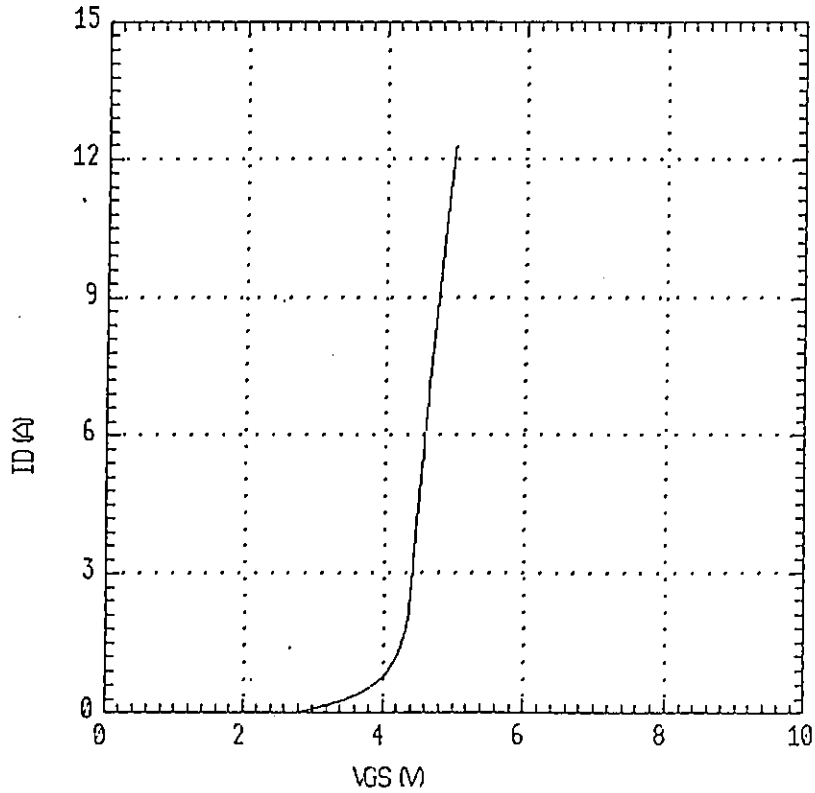

Typical Transconductance  
 $g_{fs}=f(I_D):80\mu s$  pulse test,  $V_{DS}=25V, T_{ch}=25^\circ C$

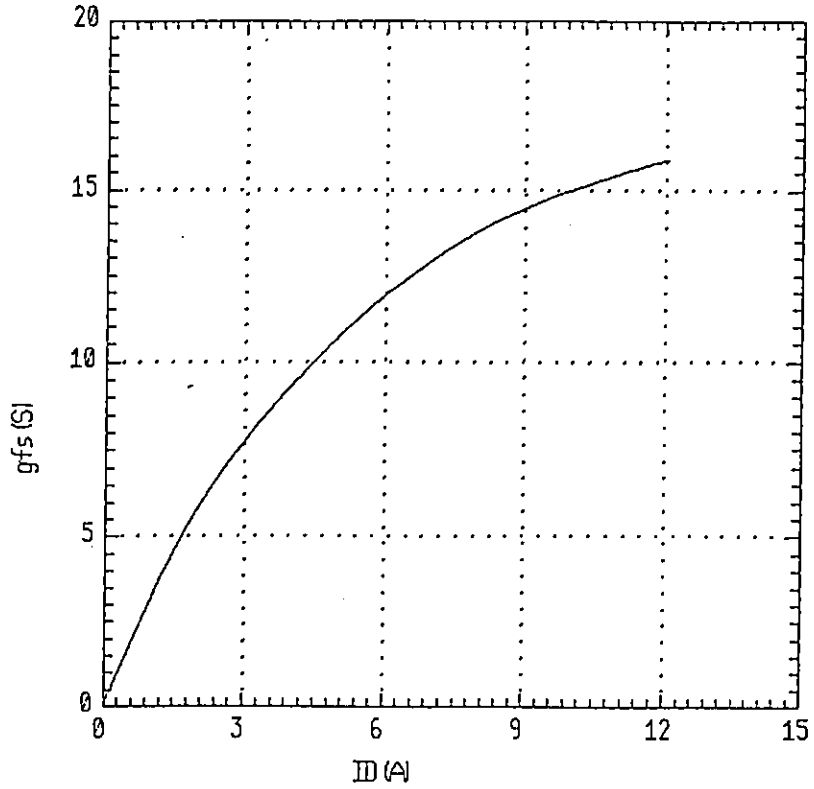

Typical Drain-source on-state resistance  
 $R_{DS(on)}=f(I_D):80\mu s$  pulse test,  $T_{ch}=25^\circ C$

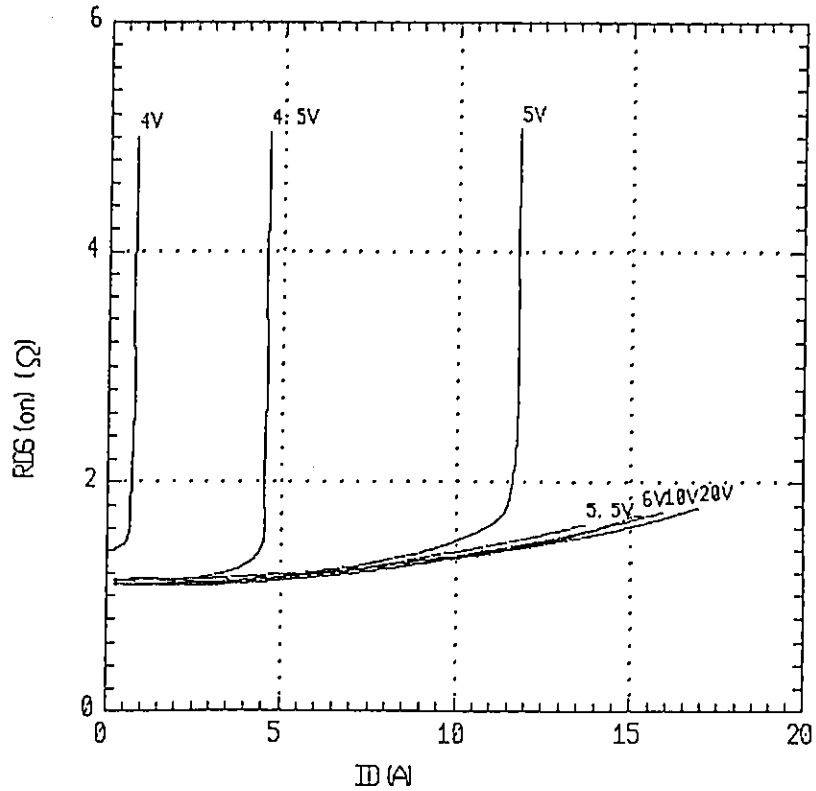



Drain-source on-state resistance  
 $R_{DS(on)} = f(T_{ch}) : I_D = 4.5A, V_{GS} = 10V$

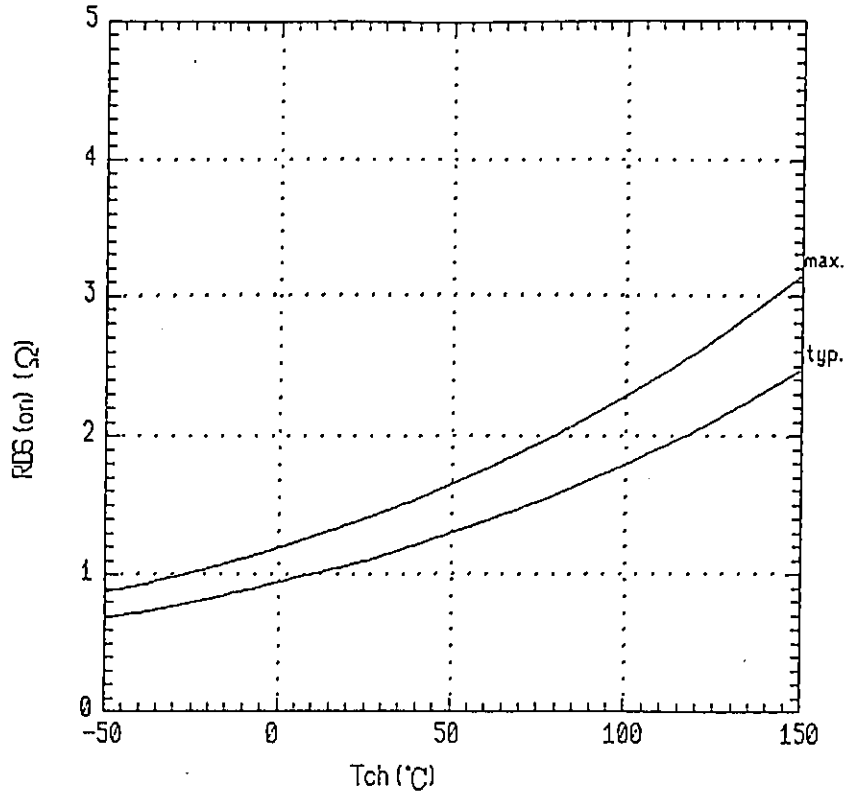

Gate threshold voltage  
 $V_{GS(th)} = f(T_{ch}) : V_{DS} = V_{GS}, I_D = 1mA$

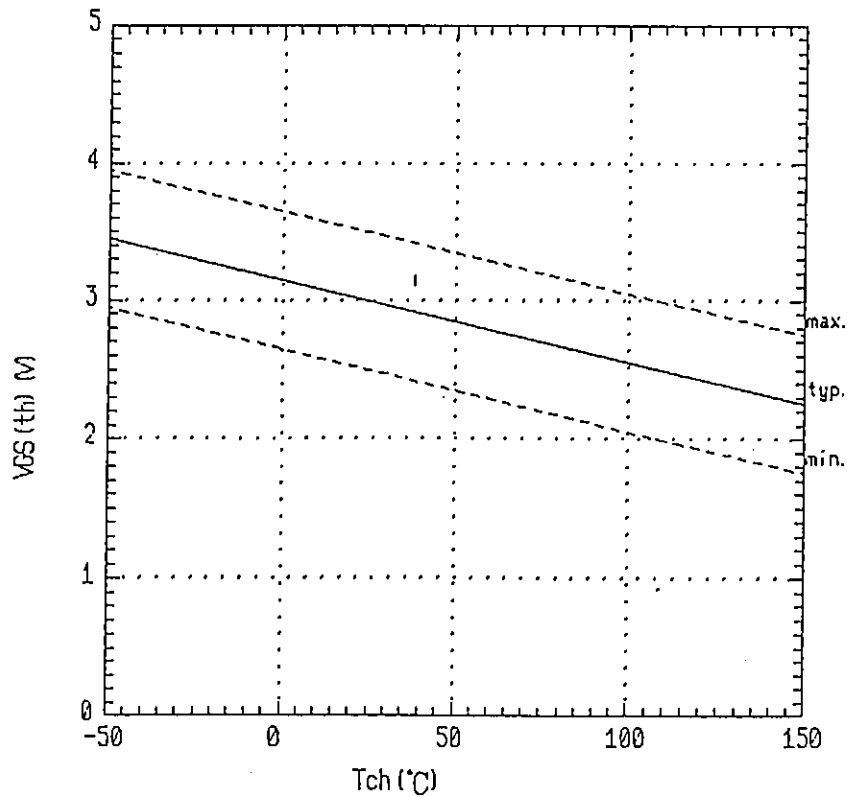

Typical gate charge characteristics

$V_{GS} = f(Q_g) : I_D = 9A$

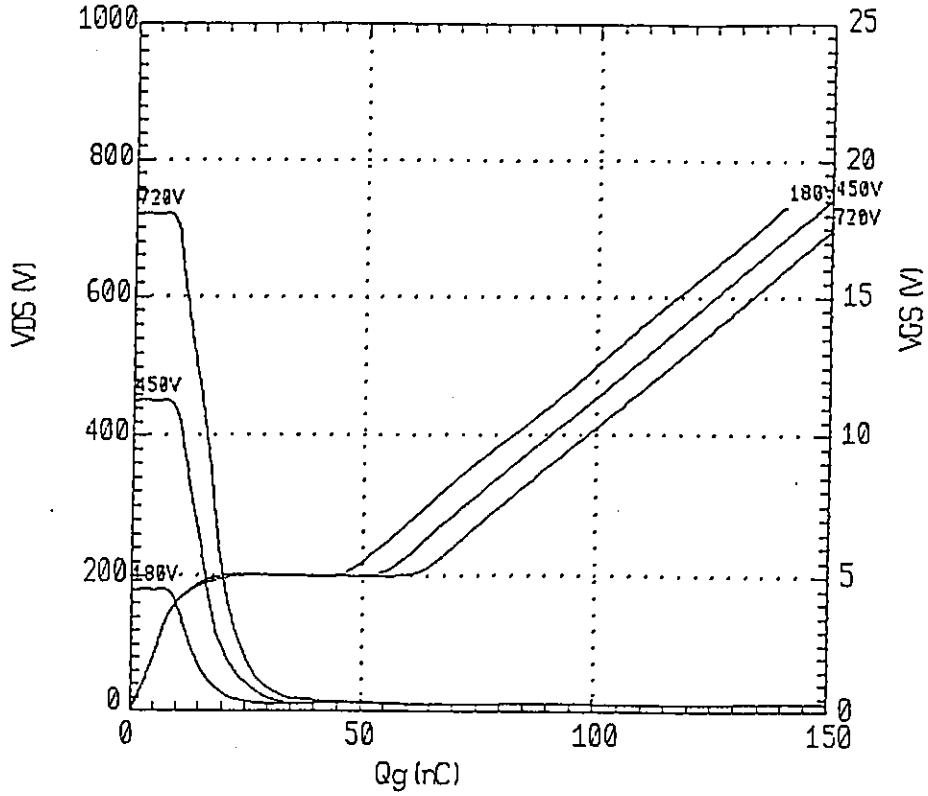

Typical capacitances

$C = f(V_{DS}) : V_{GS} = 0V, f = 1MHz$

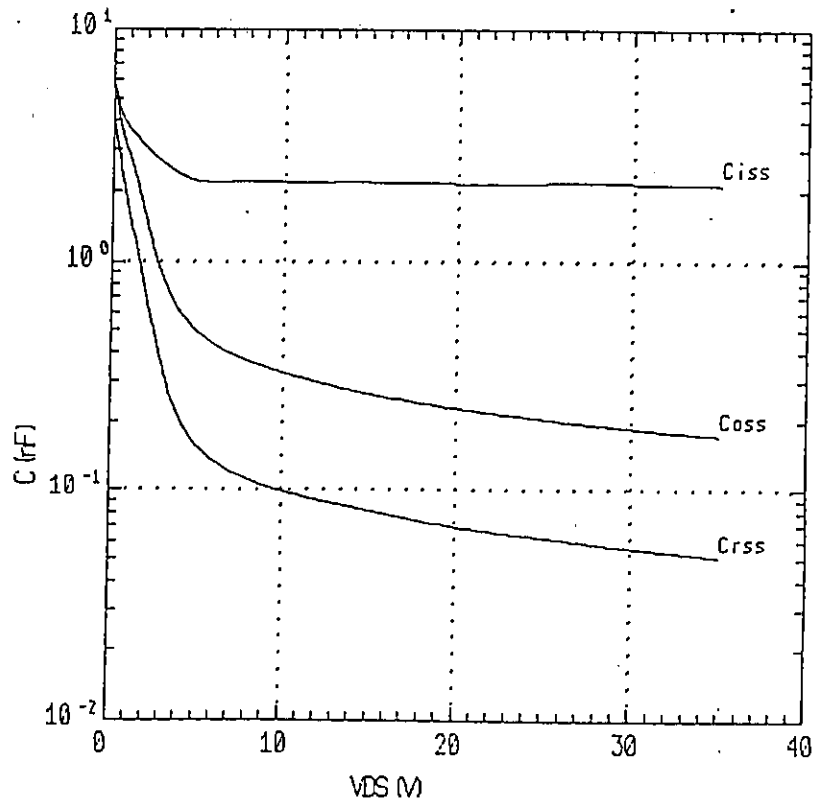

Forward characteristic of reverse diode  
 $I_F = f(V_{SD}) : 80 \mu s$  pulse test

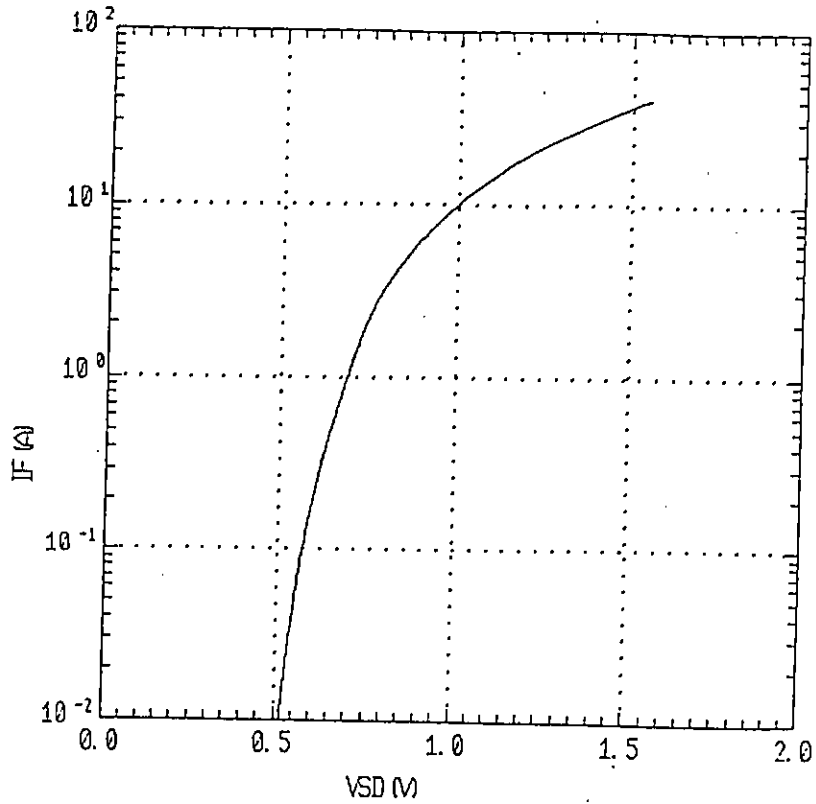

Transient thermal impedande  
 $Z_{thch} = f(t)$  parameter:  $D = t/T$

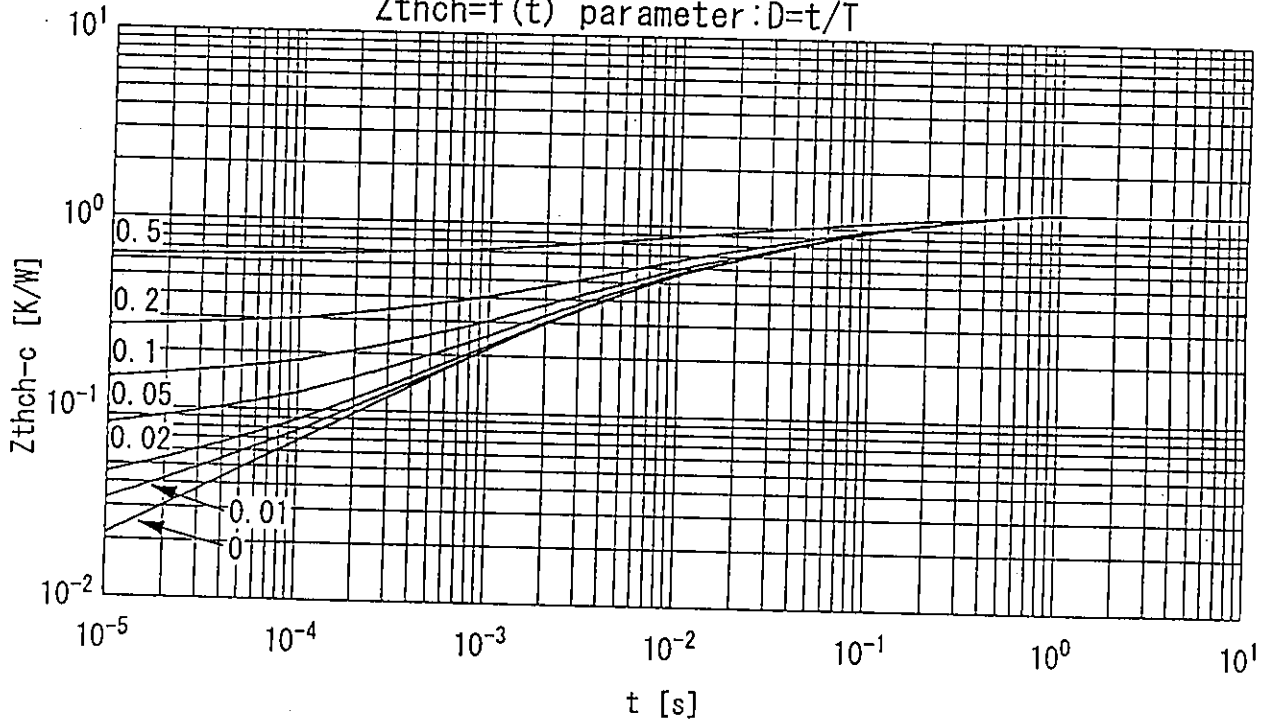

Fuji Electric Co., Ltd.

DWG. NO.

11 / 11

Y 0257-R-003a