

# JFET Transistor

## N-Channel

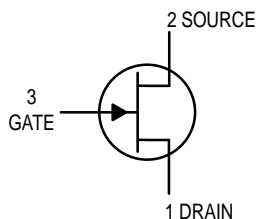

# MMBFU310LT1

Motorola Preferred Device

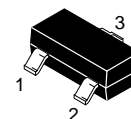

CASE 318-08, STYLE 10  
SOT-23 (TO-236AB)

### MAXIMUM RATINGS

Rating	Symbol	Value	Unit
Drain-Source Voltage	$V_{DS}$	25	Vdc
Gate-Source Voltage	$V_{GS}$	25	Vdc
Gate Current	$I_G$	10	mAdc

### THERMAL CHARACTERISTICS

Characteristic	Symbol	Max	Unit
Total Device Dissipation FR-5 Board <sup>(1)</sup> $T_A = 25^\circ\text{C}$ Derate above $25^\circ\text{C}$	$P_D$	225	mW
		1.8	mW/ $^\circ\text{C}$
Thermal Resistance, Junction to Ambient	$R_{\theta JA}$	556	$^\circ\text{C}/\text{W}$
Junction and Storage Temperature	$T_J, T_{stg}$	-55 to +150	$^\circ\text{C}$

### DEVICE MARKING

MMBFU310LT1 = 6C

### ELECTRICAL CHARACTERISTICS ( $T_A = 25^\circ\text{C}$ unless otherwise noted)

Characteristic	Symbol	Min	Max	Unit
----------------	--------	-----	-----	------

### OFF CHARACTERISTICS

Gate-Source Breakdown Voltage ( $I_G = -1.0 \mu\text{Adc}$ , $V_{DS} = 0$ )	$V_{(BR)GSS}$	-25	—	Vdc
Gate 1 Leakage Current ( $V_{GS} = -15 \text{Vdc}$ , $V_{DS} = 0$ )	$I_{G1SS}$	—	-150	pA
Gate 2 Leakage Current ( $V_{GS} = -15 \text{Vdc}$ , $V_{DS} = 0$ , $T_A = 125^\circ\text{C}$ )	$I_{G2SS}$	—	-150	nAdc
Gate Source Cutoff Voltage ( $V_{DS} = 10 \text{Vdc}$ , $I_D = 1.0 \text{nAdc}$ )	$V_{GS(off)}$	-2.5	-6.0	Vdc

### ON CHARACTERISTICS

Zero-Gate-Voltage Drain Current ( $V_{DS} = 10 \text{Vdc}$ , $V_{GS} = 0$ )	$I_{DSS}$	24	60	mAdc
Gate-Source Forward Voltage ( $I_G = 10 \text{mAdc}$ , $V_{DS} = 0$ )	$V_{GS(f)}$	—	1.0	Vdc

### SMALL-SIGNAL CHARACTERISTICS

Forward Transfer Admittance ( $V_{DS} = 10 \text{Vdc}$ , $I_D = 10 \text{mAdc}$ , $f = 1.0 \text{kHz}$ )	$ Y_{fs} $	10	18	mmhos
Output Admittance ( $V_{DS} = 10 \text{Vdc}$ , $I_D = 10 \text{mAdc}$ , $f = 1.0 \text{kHz}$ )	$ Y_{os} $	—	250	$\mu\text{mhos}$
Input Capacitance ( $V_{GS} = -10 \text{Vdc}$ , $V_{DS} = 0 \text{Vdc}$ , $f = 1.0 \text{MHz}$ )	$C_{iss}$	—	5.0	pF
Reverse Transfer Capacitance ( $V_{GS} = -10 \text{Vdc}$ , $V_{DS} = 0 \text{Vdc}$ , $f = 1.0 \text{MHz}$ )	$C_{rss}$	—	2.5	pF

1. FR-5 =  $1.0 \times 0.75 \times 0.062 \text{ in.}$

Thermal Clad is a trademark of the Bergquist Company

Preferred devices are Motorola recommended choices for future use and best overall value.

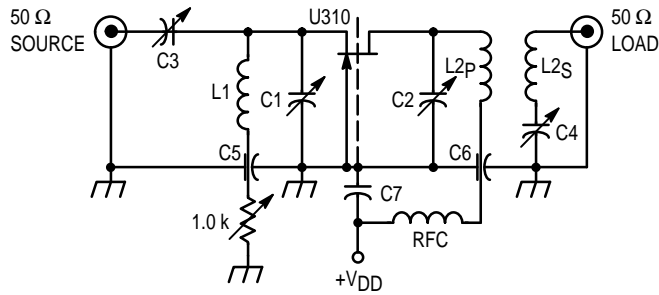

- C1 = C2 = 0.8 – 10 pF, JFD #MVM010W.
- C3 = C4 = 8.35 pF Erie #539-002D.
- C5 = C6 = 5000 pF Erie (2443-000).
- C7 = 1000 pF, Allen Bradley #FA5C.
- RFC = 0.33 μH Miller #9230-30.
- L1 = One Turn #16 Cu, 1/4" I.D. (Air Core).
- L2p = One Turn #16 Cu, 1/4" I.D. (Air Core).
- L2s = One Turn #16 Cu, 1/4" I.D. (Air Core).

Figure 1. 450 MHz Common-Gate Amplifier Test Circuit

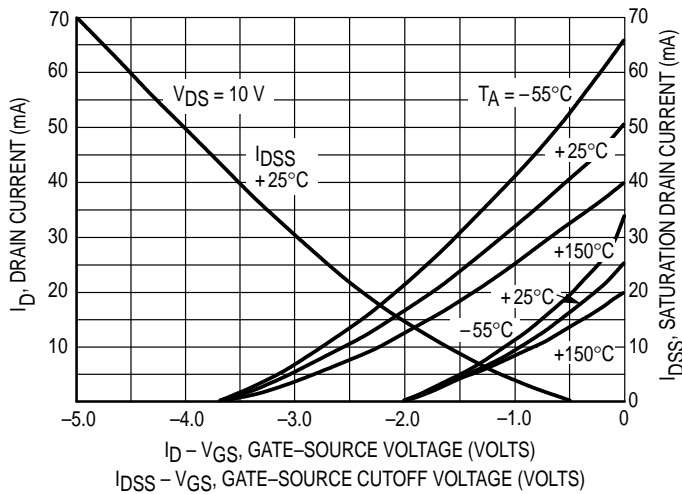

Figure 2. Drain Current and Transfer Characteristics versus Gate-Source Voltage

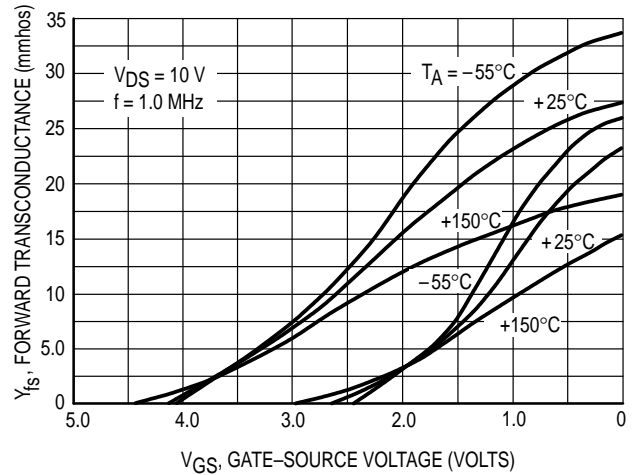

Figure 3. Forward Transconductance versus Gate-Source Voltage

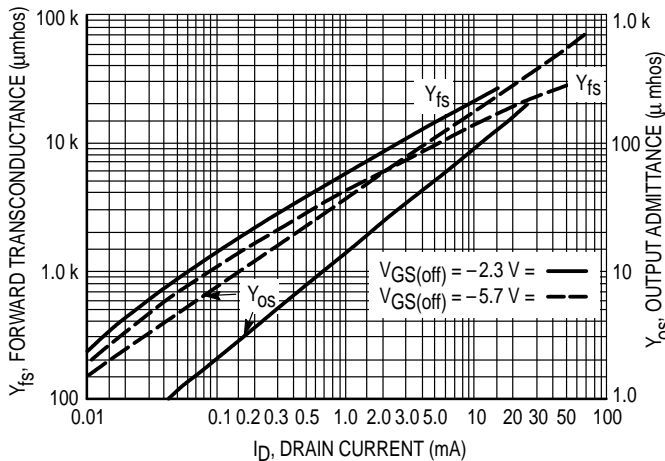

Figure 4. Common-Source Output Admittance and Forward Transconductance versus Drain Current

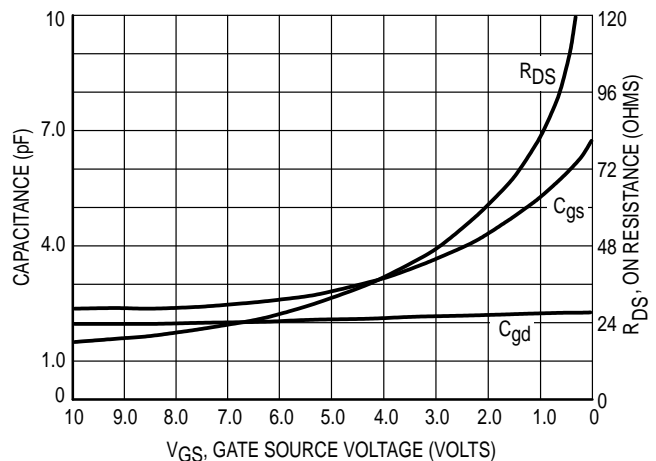

Figure 5. On Resistance and Junction Capacitance versus Gate-Source Voltage

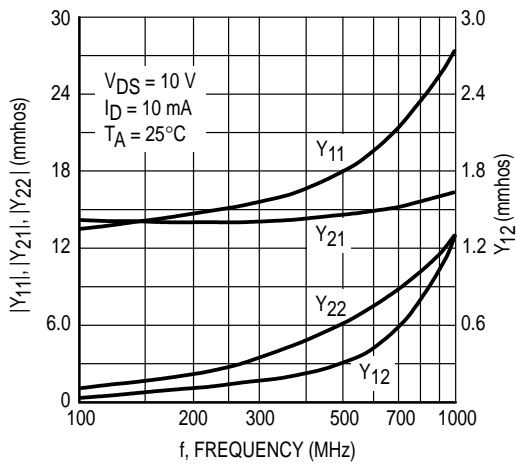

Figure 6. Common-Gate Y Parameter Magnitude versus Frequency

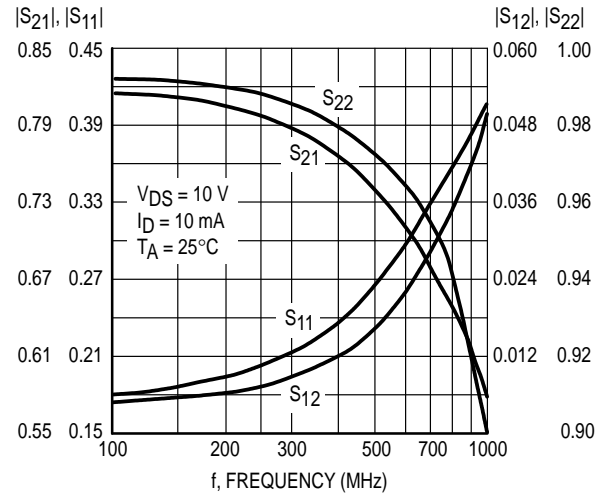

Figure 7. Common-Gate S Parameter Magnitude versus Frequency

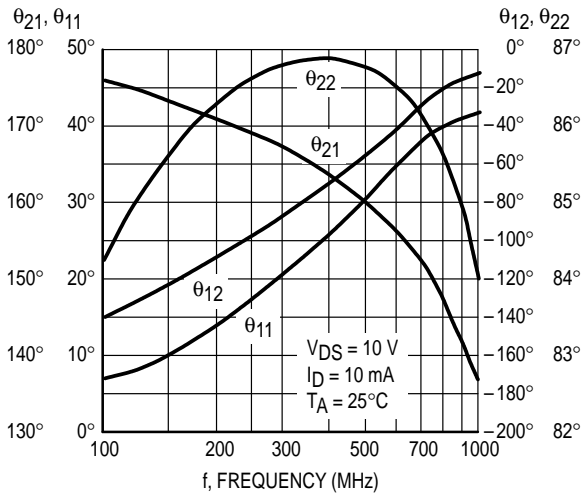

Figure 8. Common-Gate Y Parameter Phase-Angle versus Frequency

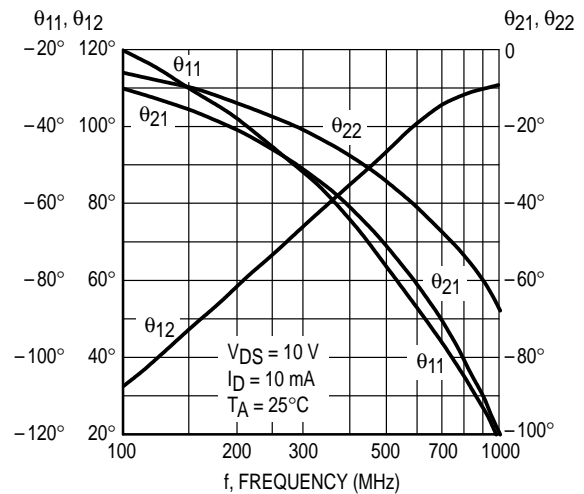

Figure 9. S Parameter Phase-Angle versus Frequency

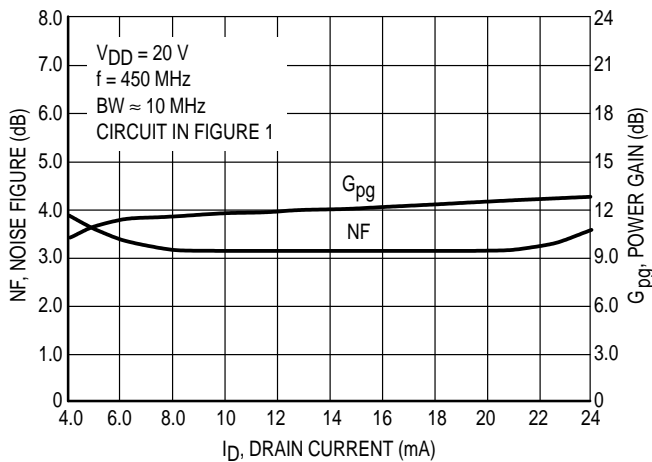

Figure 10. Noise Figure and Power Gain versus Drain Current

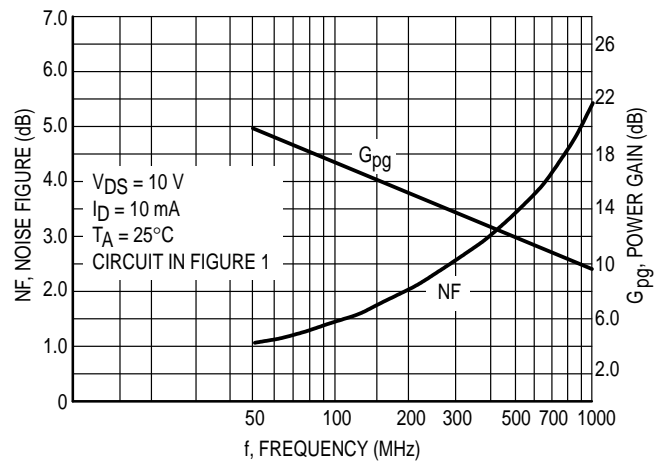
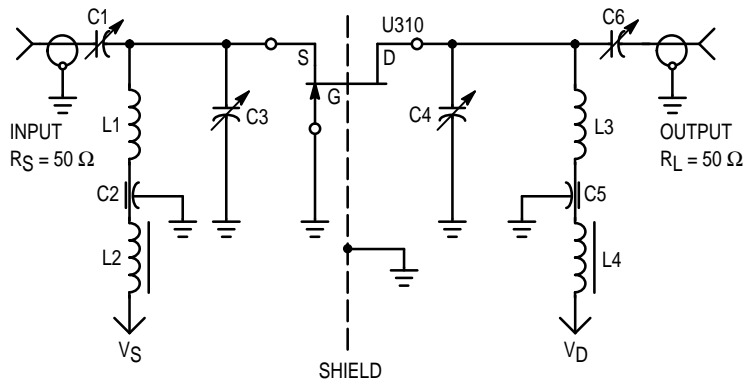

Figure 11. Noise Figure and Power Gain versus Frequency

**MMBFU310LT1**



$B_W$  (3 dB) – 36.5 MHz  
 $I_D$  – 10 mAdc  
 $V_{DS}$  – 20 Vdc  
 Device case grounded  
 IM test tones –  $f_1 = 449.5$  MHz,  $f_2 = 450.5$  MHz  
 $C_1 = 1-10$  pF Johanson Air variable trimmer.  
 $C_2, C_5 = 100$  pF feed thru button capacitor.  
 $C_3, C_4, C_6 = 0.5-6$  pF Johanson Air variable trimmer.  
 $L_1 = 1/8'' \times 1/32'' \times 1-5/8''$  copper bar.  
 $L_2, L_4 =$  Ferroxcube Vk200 choke.  
 $L_3 = 1/8'' \times 1/32'' \times 1-7/8''$  copper bar.

**Figure 12. 450 MHz IMD Evaluation Amplifier**

Amplifier power gain and IMD products are a function of the load impedance. For the amplifier design shown above with C4 and C6 adjusted to reflect a load to the drain resulting in a nominal power gain of 9 dB, the 3rd order intercept point (IP) value is 29 dBm. Adjusting C4, C6 to provide larger load values will result in higher gain, smaller bandwidth and lower IP values. For example, a nominal gain of 13 dB can be achieved with an intercept point of 19 dBm.

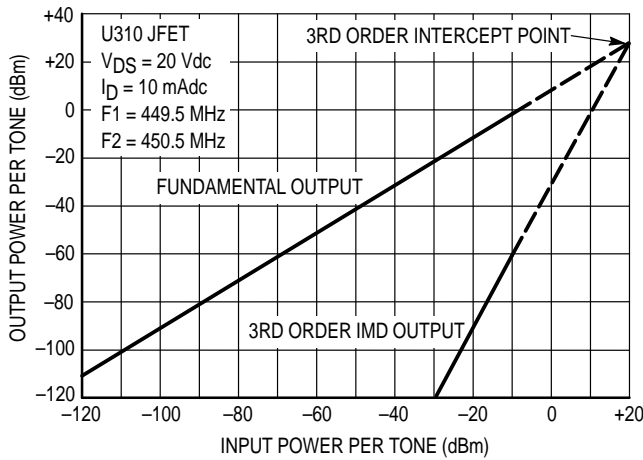

Example of intercept point plot use:  
 Assume two in-band signals of  $-20$  dBm at the amplifier input. They will result in a 3rd order IMD signal at the output of  $-90$  dBm. Also, each signal level at the output will be  $-11$  dBm, showing an amplifier gain of 9.0 dB and an intermodulation ratio (IMR) capability of 79 dB. The gain and IMR values apply only for signal levels below comparison.

**Figure 13. Two Tone 3rd Order Intercept Point**

## INFORMATION FOR USING THE SOT-23 SURFACE MOUNT PACKAGE

### MINIMUM RECOMMENDED FOOTPRINT FOR SURFACE MOUNTED APPLICATIONS

Surface mount board layout is a critical portion of the total design. The footprint for the semiconductor packages must be the correct size to insure proper solder connection

interface between the board and the package. With the correct pad geometry, the packages will self align when subjected to a solder reflow process.

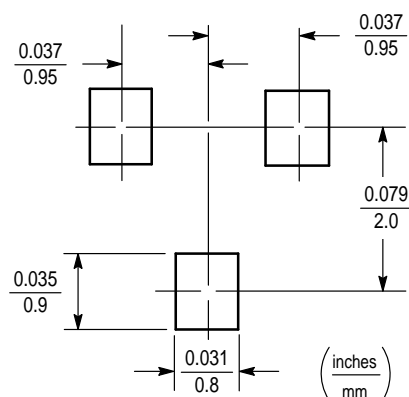

**SOT-23**

### SOT-23 POWER DISSIPATION

The power dissipation of the SOT-23 is a function of the pad size. This can vary from the minimum pad size for soldering to a pad size given for maximum power dissipation. Power dissipation for a surface mount device is determined by  $T_{J(max)}$ , the maximum rated junction temperature of the die,  $R_{\theta JA}$ , the thermal resistance from the device junction to ambient, and the operating temperature,  $T_A$ . Using the values provided on the data sheet for the SOT-23 package,  $P_D$  can be calculated as follows:

$$P_D = \frac{T_{J(max)} - T_A}{R_{\theta JA}}$$

The values for the equation are found in the maximum ratings table on the data sheet. Substituting these values into the equation for an ambient temperature  $T_A$  of 25°C, one can calculate the power dissipation of the device which in this case is 225 milliwatts.

$$P_D = \frac{150^\circ\text{C} - 25^\circ\text{C}}{556^\circ\text{C/W}} = 225 \text{ milliwatts}$$

The 556°C/W for the SOT-23 package assumes the use of the recommended footprint on a glass epoxy printed circuit board to achieve a power dissipation of 225 milliwatts. There are other alternatives to achieving higher power dissipation from the SOT-23 package. Another alternative would be to use a ceramic substrate or an aluminum core board such as Thermal Clad™. Using a board material such as Thermal Clad, an aluminum core board, the power dissipation can be doubled using the same footprint.

### SOLDERING PRECAUTIONS

The melting temperature of solder is higher than the rated temperature of the device. When the entire device is heated to a high temperature, failure to complete soldering within a short time could result in device failure. Therefore, the following items should always be observed in order to minimize the thermal stress to which the devices are subjected.

- Always preheat the device.
- The delta temperature between the preheat and soldering should be 100°C or less.\*
- When preheating and soldering, the temperature of the leads and the case must not exceed the maximum temperature ratings as shown on the data sheet. When using infrared heating with the reflow soldering method, the difference shall be a maximum of 10°C.
- The soldering temperature and time shall not exceed 260°C for more than 10 seconds.
- When shifting from preheating to soldering, the maximum temperature gradient shall be 5°C or less.
- After soldering has been completed, the device should be allowed to cool naturally for at least three minutes. Gradual cooling should be used as the use of forced cooling will increase the temperature gradient and result in latent failure due to mechanical stress.
- Mechanical stress or shock should not be applied during cooling.

\* Soldering a device without preheating can cause excessive thermal shock and stress which can result in damage to the device.

PACKAGE DIMENSIONS

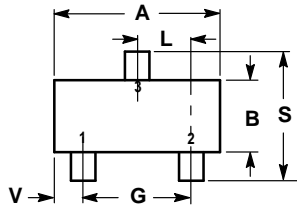

STYLE 10:  
PIN 1. DRAIN  
2. SOURCE  
3. GATE

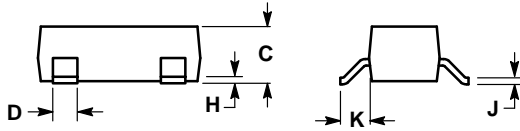

- NOTES:  
1. DIMENSIONING AND TOLERANCING PER ANSI Y14.5M, 1982.  
2. CONTROLLING DIMENSION: INCH.  
3. MAXIMUM LEAD THICKNESS INCLUDES LEAD FINISH THICKNESS. MINIMUM LEAD THICKNESS IS THE MINIMUM THICKNESS OF BASE MATERIAL.

DIM	INCHES		MILLIMETERS	
	MIN	MAX	MIN	MAX
A	0.1102	0.1197	2.80	3.04
B	0.0472	0.0551	1.20	1.40
C	0.0350	0.0440	0.89	1.11
D	0.0150	0.0200	0.37	0.50
G	0.0701	0.0807	1.78	2.04
H	0.0005	0.0040	0.013	0.100
J	0.0034	0.0070	0.085	0.177
K	0.0180	0.0236	0.45	0.60
L	0.0350	0.0401	0.89	1.02
S	0.0830	0.0984	2.10	2.50
V	0.0177	0.0236	0.45	0.60

CASE 318-08  
ISSUE AE  
SOT-23 (TO-236AB)

Motorola reserves the right to make changes without further notice to any products herein. Motorola makes no warranty, representation or guarantee regarding the suitability of its products for any particular purpose, nor does Motorola assume any liability arising out of the application or use of any product or circuit, and specifically disclaims any and all liability, including without limitation consequential or incidental damages. "Typical" parameters which may be provided in Motorola data sheets and/or specifications can and do vary in different applications and actual performance may vary over time. All operating parameters, including "Typicals" must be validated for each customer application by customer's technical experts. Motorola does not convey any license under its patent rights nor the rights of others. Motorola products are not designed, intended, or authorized for use as components in systems intended for surgical implant into the body, or other applications intended to support or sustain life, or for any other application in which the failure of the Motorola product could create a situation where personal injury or death may occur. Should Buyer purchase or use Motorola products for any such unintended or unauthorized application, Buyer shall indemnify and hold Motorola and its officers, employees, subsidiaries, affiliates, and distributors harmless against all claims, costs, damages, and expenses, and reasonable attorney fees arising out of, directly or indirectly, any claim of personal injury or death associated with such unintended or unauthorized use, even if such claim alleges that Motorola was negligent regarding the design or manufacture of the part. Motorola and  are registered trademarks of Motorola, Inc. Motorola, Inc. is an Equal Opportunity/Affirmative Action Employer.

How to reach us:

USA/EUROPE/Locations Not Listed: Motorola Literature Distribution;  
P.O. Box 20912; Phoenix, Arizona 85036. 1-800-441-2447 or 602-303-5454

JAPAN: Nippon Motorola Ltd.; Tatsumi-SPD-JLDC, 6F Seibu-Butsuryu-Center,  
3-14-2 Tatsumi Koto-Ku, Tokyo 135, Japan. 03-81-3521-8315

MFAX: RMFAX0@email.sps.mot.com - TOUCHTONE 602-244-6609  
INTERNET: http://Design-NET.com

ASIA/PACIFIC: Motorola Semiconductors H.K. Ltd.; 8B Tai Ping Industrial Park,  
51 Ting Kok Road, Tai Po, N.T., Hong Kong. 852-26629298

