

SRS Dialog Clarity Processor

■GENERAL DESCRIPTION

The **NJM2194** is a SRS Dialog Clarity Processor to enhance the dialog in a stereo signal by extracting the dialog information, augmenting it using a proprietary dialog clarity algorithm, and mixing it back in to the final stereo audio signal. When this stereo audio is played, the speech dialog becomes much easier to clearly hear while leaving the ambient information unchanged and the volume at a normal, more comfortable level for others in the room at the time.

The **NJM2194** is suitable for audio applications such as TV, DVD and others.

■PACKAGE OUTLINE

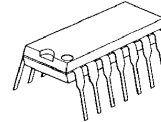

NJM2194D

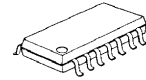

NJM2194M

■FEATURES

- Operating Voltage +4.7 to +13V
- Low Output Noise 10 μ Vrms typ. (Dialog Clarity mode, VR:MAX)
- Adjustable Dialog Clarity Effect
- Internal Mode Control Switch
- Bipolar Technology
- Package Outline DIP14, DMP14

■PIN CONFIGURATION

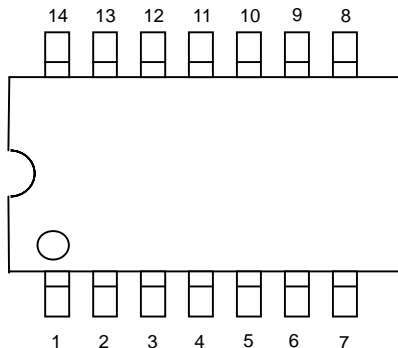

- | | |
|-----------|---------|
| 1.VROUT | 8.SW |
| 2.VRIN | 9.CIN |
| 3.TP | 10.COUT |
| 4.VREFOUT | 11.ROUT |
| 5.VREFIN | 12.LOUT |
| 6.V+ | 13.RIN |
| 7.GND | 14.LIN |

The Dialog Clarity technology right incorporated in the NJM2194 are owned by SRS Labs, a U.S. Corporation and licensed to New Japan Radio Co., Ltd. Purchaser of NJM2194 must sign a license for use of the chip and display of the SRS Labs trademarks. Any products incorporating the NJM2194 must be sent to SRS Labs for review. Dialog Clarity is protected under U.S. and foreign patents issued and/or pending. Dialog Clarity, SRS and the symbol are trademarks of SRS Labs, Inc. in the United States and selected foreign countries. Neither the purchase of the NJM2194, nor the corresponding sale of audio enhancement equipment conveys the right to sell commercialized recordings made with any SRS technology.

SRS Labs requires all set makers to comply with all rules and regulations as outlined in the SRS Trademark Usage Manual separately provided.

For further information, please contact:
 SRS Labs, Inc.
 2909 Daimler Street. Santa Ana, CA 92705 USA
 Tel: 949-442-1070 Fax: 949-852-1099 <http://www.srslabs.com>

NJM2194

■BLOCK DIAGRAM

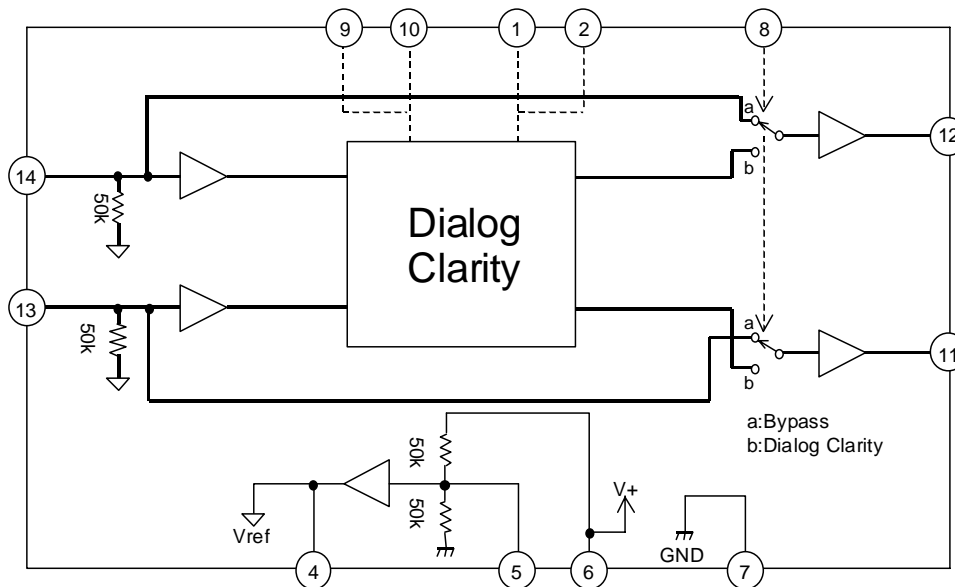

■ABSOLUTE MAXIMUM RATINGS (Ta=25°C)

PARAMETER	SYMBOL	RATINGS	UNIT
Supply Voltage	V ⁺	14	V
Power Dissipation	P _D	(DIP14) 500 (DMP14) 350	mW
Operating Temperature Range	T _{opr}	-40 to +85	°C
Storage Temperature Range	T _{stg}	-40 to +125	°C

■OPERATING VOLTAGE

PARAMETER	SYMBOL	TEST CONDITION	MIN.	TYP.	MAX.	UNIT
Operating Voltage	V ⁺	-	4.7	12.0	13.0	V

■ELECTRICAL CHARACTERISTICS (Ta=25°C, V⁺=12V unless otherwise specified)

PARAMETER	SYMBOL	TEST CONDITION						MIN.	TYP.	MAX.	UNIT
		INPUT		OUTPUT	MODE	VR					
		L	R								
Operating Current	I _{CC}	No Signal	0	0	-	Bypass	-	-	5.7	8.6	mA
			0	0	-	DC	MAX	-	-	5.7	
Reference Voltage	V _{REF}	No Signal	0	0	-	-	-	5.8	6.0	6.2	V

● AC CHARACTERISTICS

($T_a=25^\circ\text{C}$, $V^+=12\text{V}$, $V_{IN}=-10\text{dBV}$ (=316mVrms), $f=1\text{kHz}$, $R_L=4.7\text{k}\Omega$ unless otherwise specified)

PARAMETER	SYMBOL	TEST CONDITION						MIN.	TYP.	MAX.	UNIT		
		INPUT		OUTPUT	MODE	VR							
		L	R										
Maximum Input Voltage	V_{IM}	$f=1\text{kHz}$ THD=3%	V_{IN} 0	0 V_{IN}	L R	Bypass	-	100 (3.1)	12.0 (3.9)	-	dBV (Vrms)		
		$f=1\text{kHz}$ THD=3%	V_{IN} 0	0 V_{IN}	L R	DC	MAX	34 (1.5)	5.4 (1.9)	-			
Output Noise	V_{NO}	$R_g=0\Omega$ A-Weighted	0	0	L R	Bypass	-	-	-112 (2.5)	-106 (5.0)	dBV (μVrms)		
		$R_g=0\Omega$ A-Weighted	0	0	L R	DC	MAX	-	-100 (10)	-94 (20)			
Total Harmonic Distortion	THD	$f=1\text{kHz}$	V_{IN} 0	0 V_{IN}	L R	Bypass	-	-	0.005	0.01	%		
		$f=1\text{kHz}$ $V_{IN}=-20\text{dBV}$	V_{IN} 0	0 V_{IN}	L R	DC	MAX	-	0.1	0.5			
Bypass Gain	G_{VBYP}	$f=1\text{kHz}$	V_{IN} 0	0 V_{IN}	L R	Bypass	-	-1.0	0.0	1.0	dB		
Dialog Clarity Gain	G_{VDC}	$f=1\text{kHz}$ $V_{IN}=-20\text{dBV}$	V_{IN} 0	0 V_{IN}	L R	DC	MAX	4.4	6.4	8.4	dB		
		$f=1\text{kHz}$ $V_{IN}=-20\text{dBV}$	0 V_{IN}	V_{IN} 0	L R	DC	MAX	-0.4	1.6	3.6			
		$f=1\text{kHz}$ $V_{IN}=-20\text{dBV}$	V_{IN} 0	0 V_{IN}	L R	DC	MIN	-1.0	0.0	1.0			

● CONTROL CHARACTERISTICS ($T_a=25^\circ\text{C}$, $V^+=12\text{V}$ unless otherwise specified)



PARAMETER	SYMBOL	TEST CONDITION	MIN.	TYP.	MAX.	UNIT
Mode Select Control Voltage	V_{MODE}	$V_{IN}=\text{High Level}$	2.0	-	V^+	V
		$V_{IN}=\text{Low Level}$	0.0	-	0.7	

■ MODE SWITCH

MODE	SW	NOTES
Bypass	L or Open	Input Through
Dialog Clarity (DC)	H	Dialog Clarity mode

NJM2194

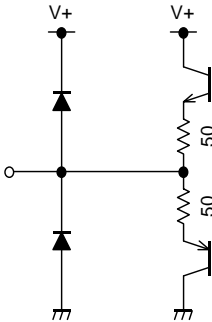
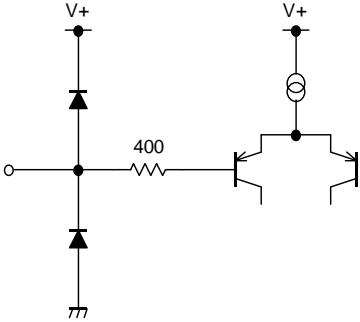
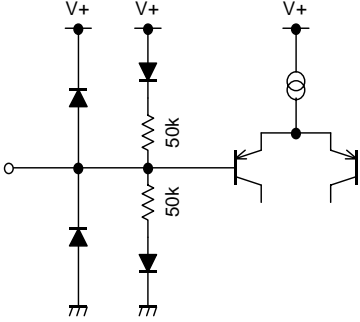
■ TERMINAL DESCRIPTION

PIN No.	SYMBOL	EQUIVALENT CIRCUIT	VOLTAGE	NOTE
1 4 10 11 12	VROUT VREFOUT COUT ROUT LOUT		$V^+/2$	
2 3	VRIN TP		$V^+/2$	
5	VREFIN		$V^+/2$	
6	V^+		V^+	

■ TERMINAL DESCRIPTION

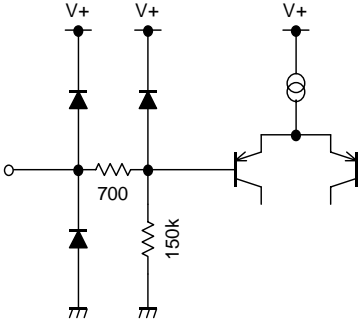
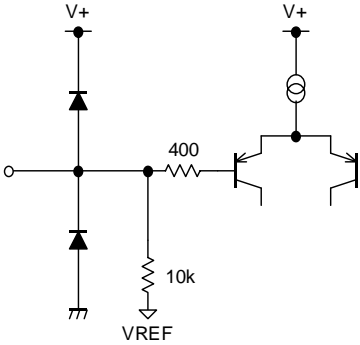
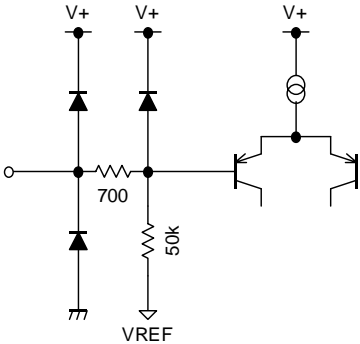
PIN No.	SYMBOL	EQUIVALENT CIRCUIT	VOLTAGE	NOTE
7	GND		0V	
8	SW		0V	
9	CIN		$V^+/2$	
13 14	RIN LIN		$V^+/2$	

NJM2194

APPLICATION CIRCUIT

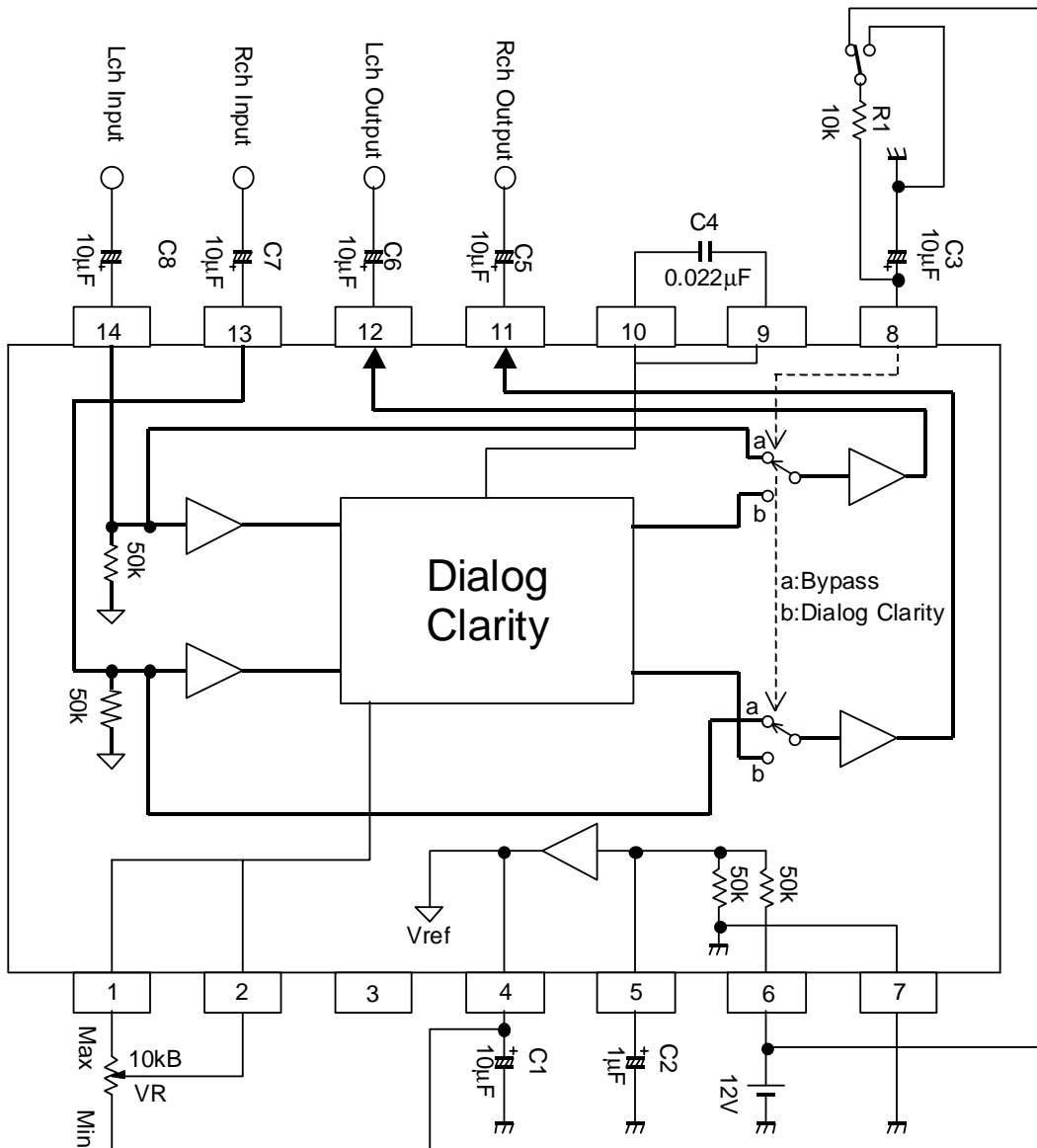

*) Dialog Clarity Effect is adjustable with the VR

TYPICAL CHARACTERISTICS

Operating Current vs. Operating Voltage

$V_+ = 1$ to $15V$, $T_a = 25^\circ C$

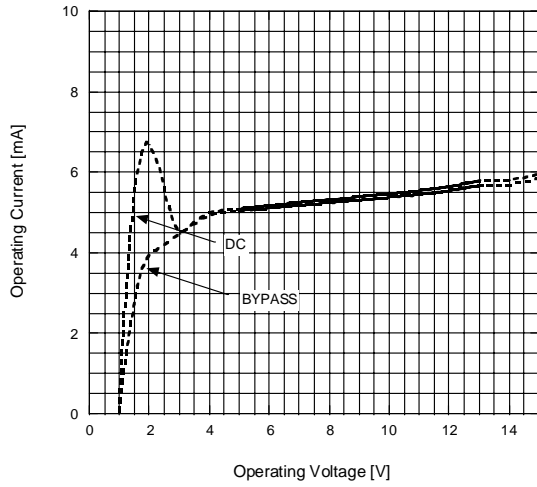

Operating Current vs. Temperature

$V_+ = 12V$

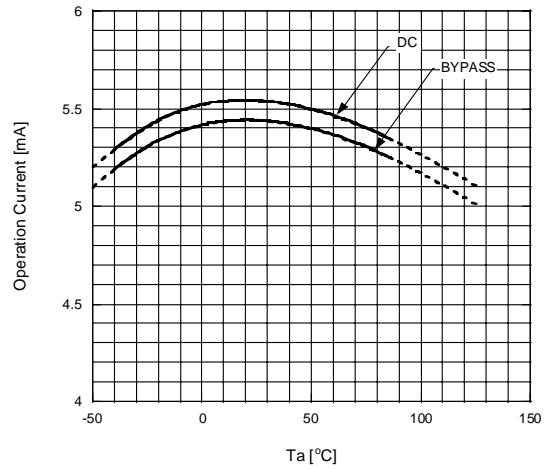

Maximum Input Voltage vs. Operating Voltage (BYPASS)

$V_{in} = Lch$, $V_{out} = Lch$, $f = 1kHz$, $R_L = 4.7k\Omega$,
 $R_g = 25\Omega$, $T_a = 25^\circ C$

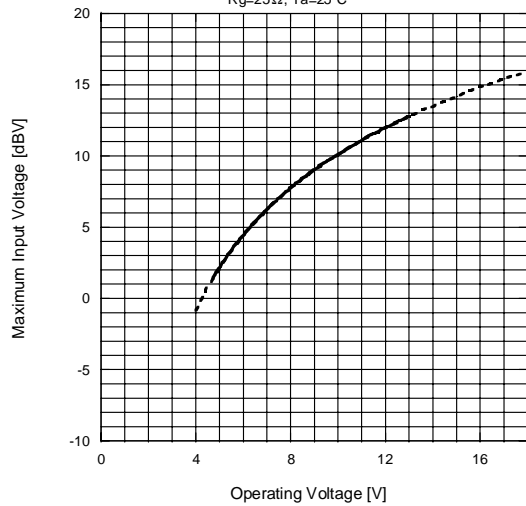

Maximum Input Voltage vs. Operating Voltage (DC)

$V_{in} = Lch$, $V_{out} = Lch$, $f = 1kHz$, $R_L = 4.7k\Omega$,
 $R_g = 25\Omega$, $T_a = 25^\circ C$

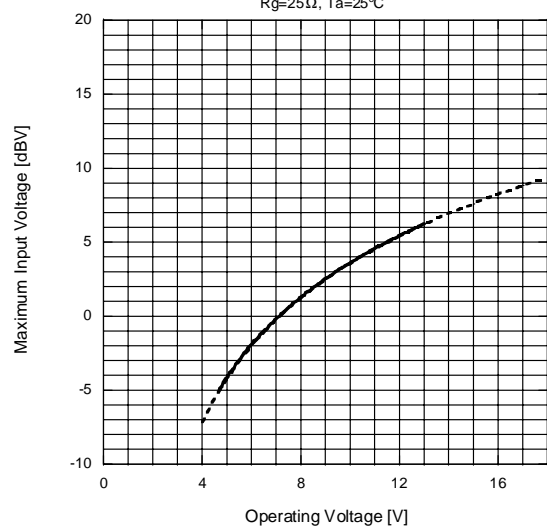

Maximum Input Voltage vs. Temperature (BYPASS)

$V_+ = 12V$, $V_{in} = Lch$, $V_{out} = Lch$, $f = 1kHz$, $R_L = 4.7k\Omega$,
 $R_g = 25\Omega$

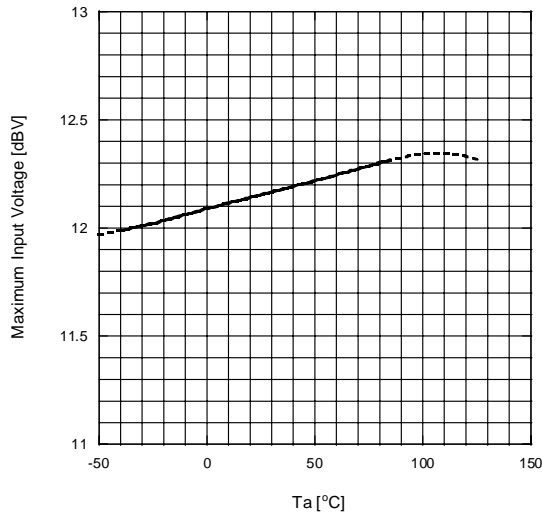

Maximum Input Voltage vs. Temperature (DC)

$V_+ = 12V$, $V_{in} = Lch$, $V_{out} = Lch$, $f = 1kHz$, $R_L = 4.7k\Omega$,
 $R_g = 25\Omega$

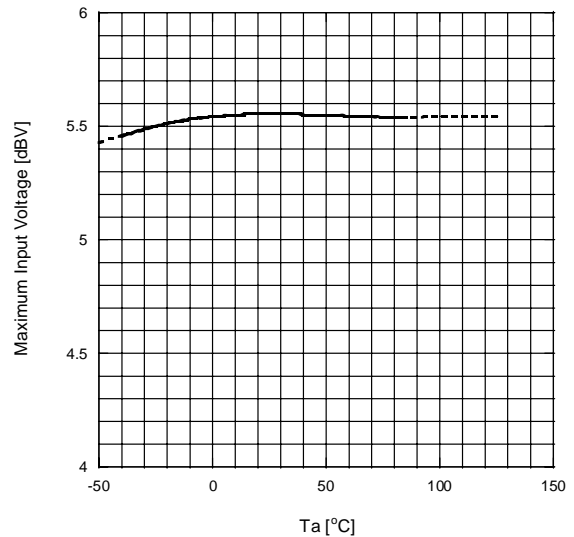

TYPICAL CHARACTERISTICS

Output vs. Temperature

V+=12V, Vin=GND, Vout=Lch

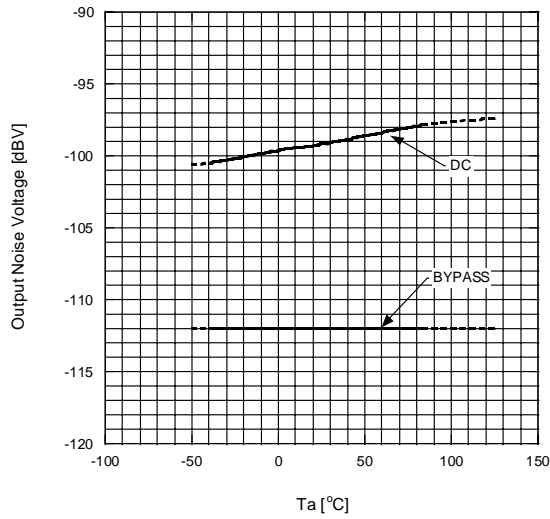

Output Noise Voltage vs. temperature

V+=12V, Vin=GND, Vout=Rch

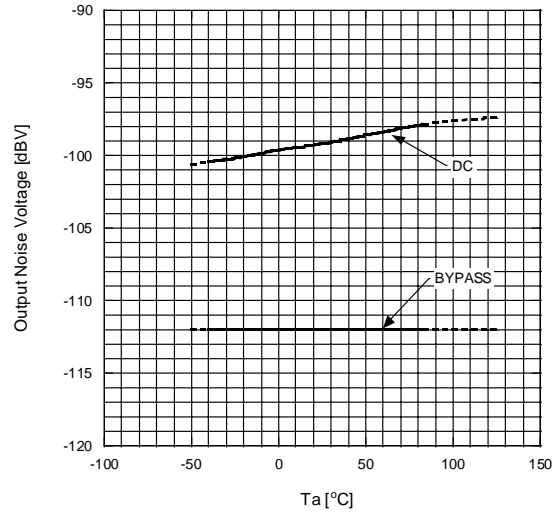

Total Harmonic Distortion vs. Input Voltage (BYPASS)

V+=12V, Vin=Lch, Vout=Lch, f=100Hz, RL=4.7kΩ
Rg=25Ω, BW=10-80kHz

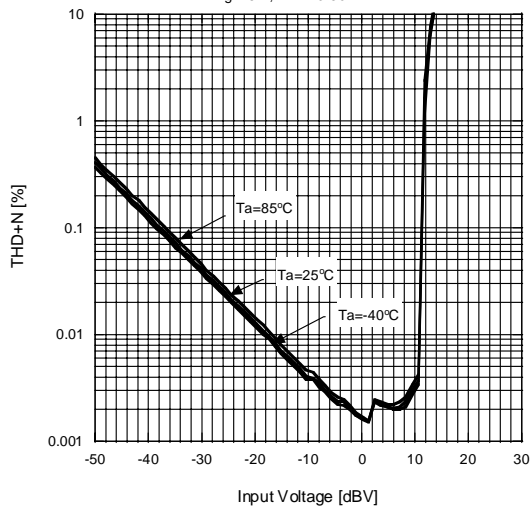

Total Harmonic Distortion vs. Input Voltage (BYPASS)

V+=12V, Vin=Lch, Vout=Lch, f=1kHz, RL=4.7kΩ
Rg=25Ω, BW=10-80kHz

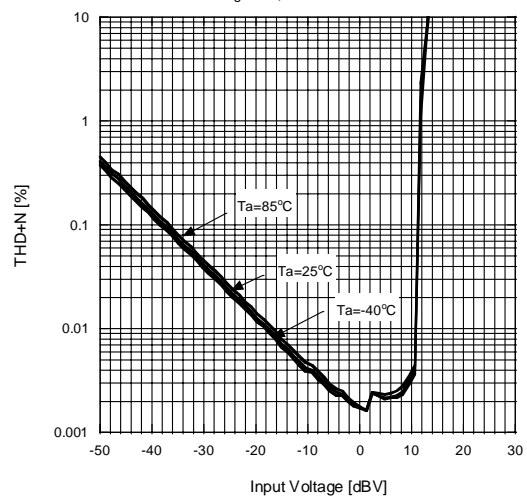

Total Harmonic Distortion vs. Input Voltage (BYPASS)

V+=12V, Vin=Lch, Vout=Lch, f=10kHz, RL=4.7kΩ
Rg=25Ω, BW=10-80kHz

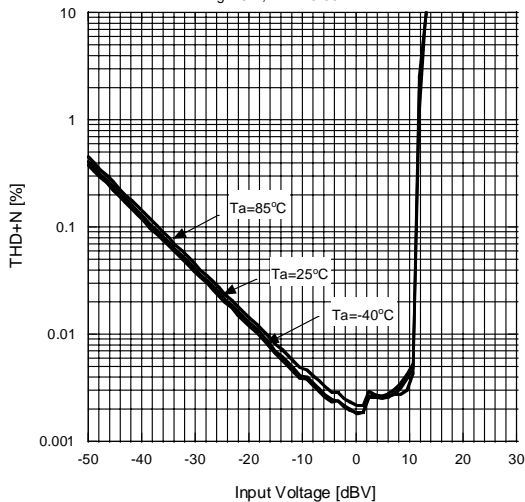

Total Harmonic Distortion vs. Input Voltage (DC)

V+=12V, Vin=Lch, Vout=Lch, f=1kHz, RL=4.7kΩ
Rg=25Ω, BW=10-80kHz

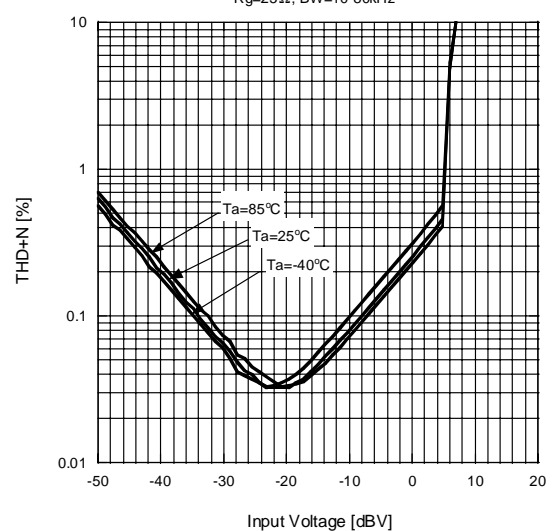

TYPICAL CHARACTERISTICS

Total Harmonic Distortion vs. Input Voltage (DC)

$V_+ = 12V$, $V_{in} = Lch$, $V_{out} = Lch$, $f = 10kHz$, $R_L = 4.7k\Omega$,
 $R_g = 25\Omega$, $BW = 10-80kHz$

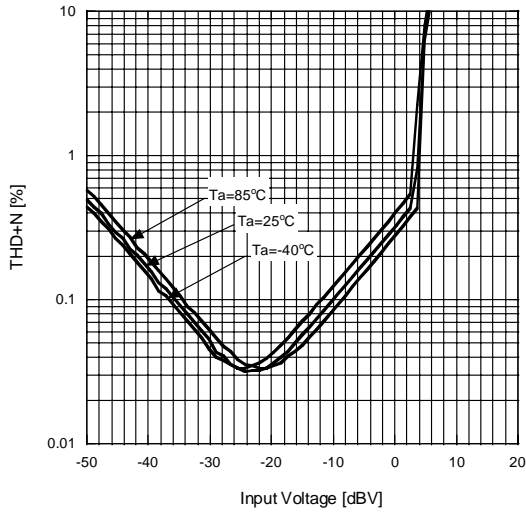

Frequency Response (BYPASS)

$V_+ = 12V$, $V_{in} = 10dBV$ Lch, $V_{out} = Lch$, $R_L = 4.7k\Omega$,
 $R_g = 25\Omega$

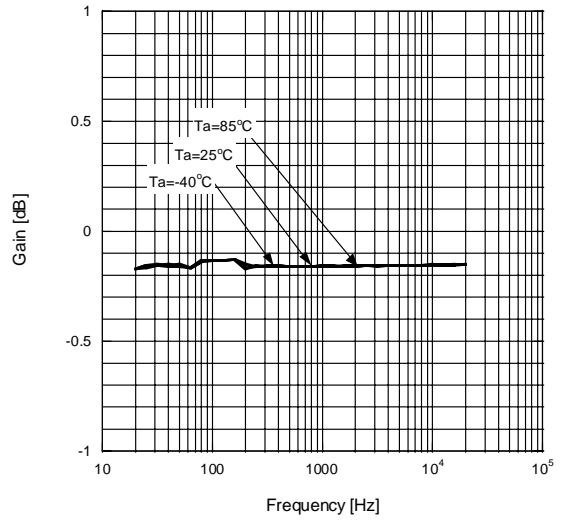

Frequency Response (DC)

$V_+ = 12V$, $V_{in} = 20dBV$ Lch, $V_{out} = Lch$, $R_L = 4.7k\Omega$, $R_g = 25\Omega$

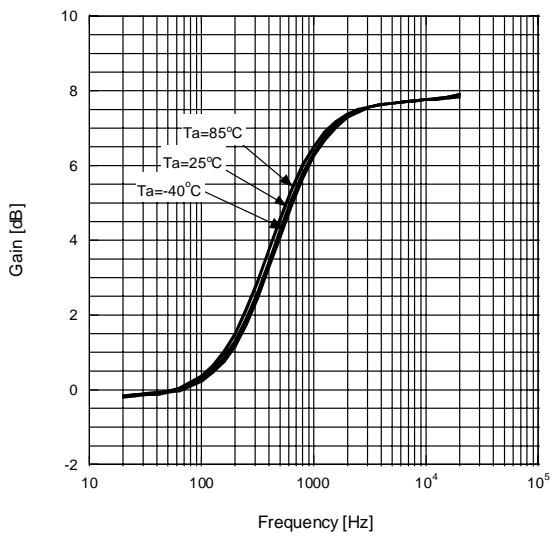

Frequency Response (DC)

$V_+ = 12V$, $V_{in} = 20dBV$ Lch, $V_{out} = Rch$, $R_L = 4.7k\Omega$, $R_g = 25\Omega$

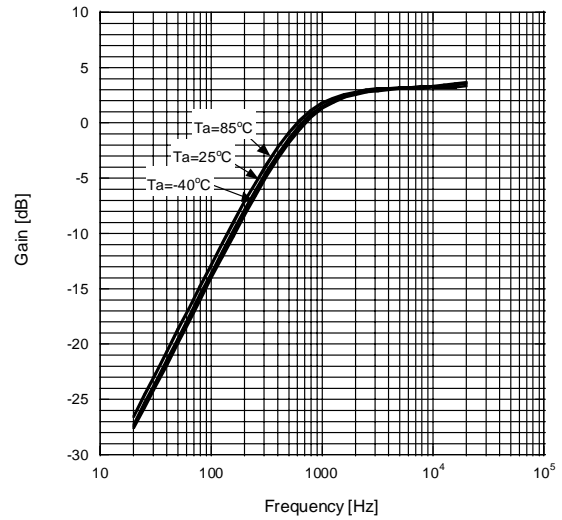

Gain vs. SW Control Voltage

$V_+ = 12V$, $V_{in} = 20dBV$ Lch, $V_{out} = Lch$, $f = 1kHz$,
BYPASS \rightarrow DC

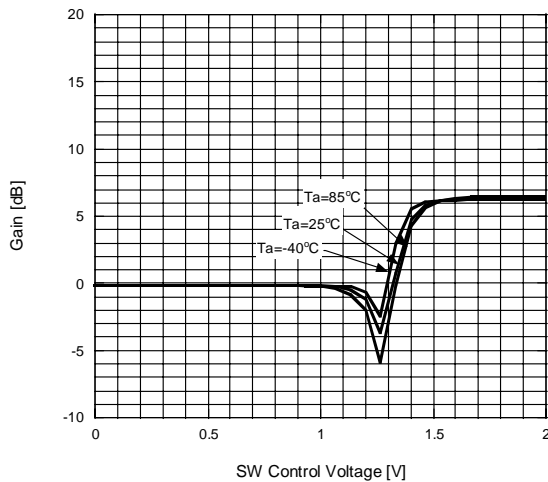

DC Offset Voltage vs. Temperature

$V_+ = 12V$, $V_{out} = Lch$

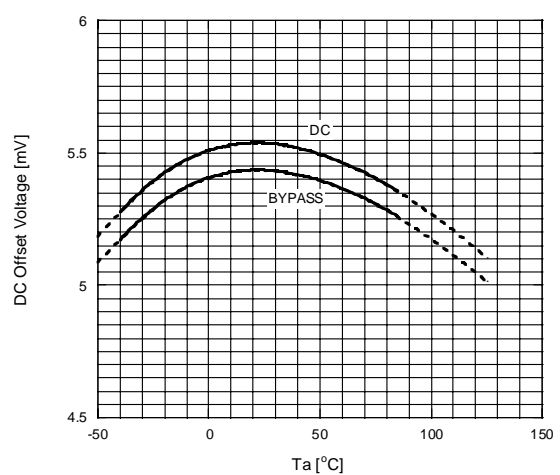

■ TYPICAL CHARACTERISTICS

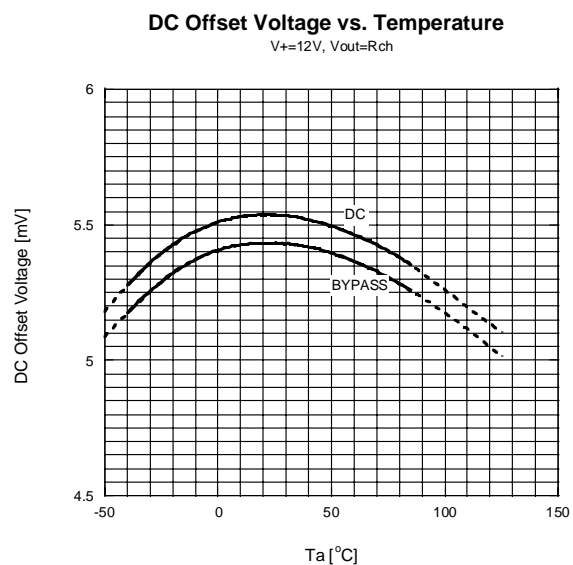

[CAUTION]

The specifications on this databook are only given for information, without any guarantee as regards either mistakes or omissions. The application circuits in this databook are described only to show representative usages of the product and not intended for the guarantee or permission of any right including the industrial rights.