

MITSUBISHI DIODE MODULES
RM10TA-24,-2H

HIGH VOLTAGE MEDIUM POWER GENERAL USE
 INSULATED TYPE

RM10TA-24,-2H

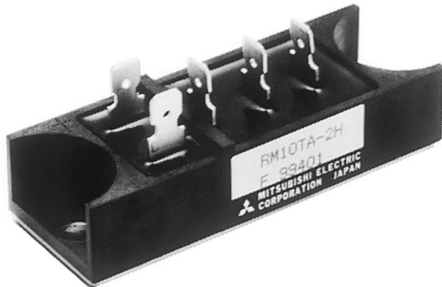

- I_o DC output current 20A
- V_{RRM} Repetitive peak reverse voltage
 1200/1600V

- 3 phase bridge
- Insulated Type
- UL Recognized

Yellow Card No. E80276 (N)
 File No. E80271

APPLICATION

AC motor controllers, DC motor controllers, Battery DC power supplies,
 DC power supplies for control panels, and other general DC power equipment

OUTLINE DRAWING & CIRCUIT DIAGRAM

Dimensions in mm

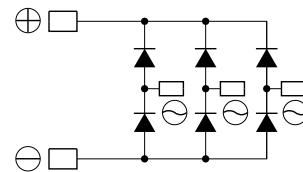
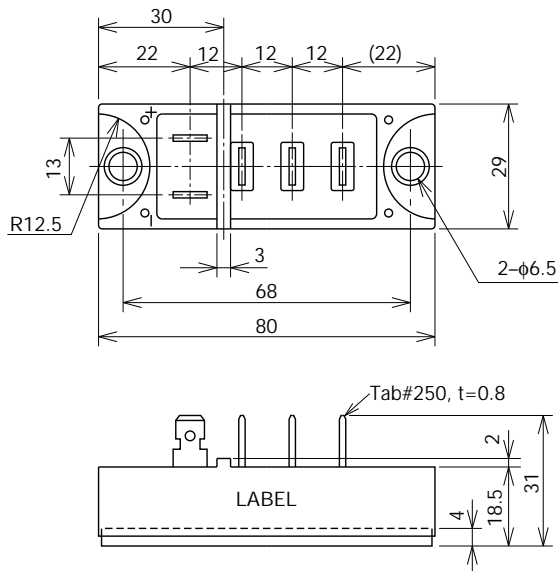

RM10TA-24,-2H

HIGH VOLTAGE MEDIUM POWER GENERAL USE
INSULATED TYPE

ABSOLUTE MAXIMUM RATINGS

| Symbol | Parameter | Voltage class | | Unit |
|--------|-------------------------------------|---------------|------|------|
| | | 24 | 2H | |
| VRRM | Repetitive peak reverse voltage | 1200 | 1600 | V |
| VRSM | Non-repetitive peak reverse voltage | 1350 | 1700 | V |
| Ea | Recommended AC input voltage | 370 | 440 | V |

| Symbol | Parameter | Conditions | Ratings | Unit |
|-----------------------------|--|---|-----------------------|------------------|
| I _o | DC output current | Three-phase full wave rectifying circuit, T _c =100°C | 20 | A |
| I _{FSM} | Surge (non-repetitive) forward current | One half cycle at 60Hz, peak value | 200 | A |
| I ² _t | I ² _t for fusing | Value for one cycle of surge current | 1.7 × 10 ² | A ² s |
| f | Maximum operating frequency | | 1000 | Hz |
| T _j | Junction temperature | | -40 ~ +150 | °C |
| T _{stg} | Storage temperature | | -40 ~ +125 | °C |
| V _{iso} | Isolation voltage | Charged part to case | 2500 | V |
| — | Mounting torque | Mounting screw M6 | 1.96-2.94 | N·m |
| — | Weight | Typical value | 20-30 | kg·cm |
| — | | | 120 | g |

ELECTRICAL CHARACTERISTICS

| Symbol | Parameter | Test conditions | Limits | | | Unit |
|-----------------------|----------------------------|---|--------|------|------|------|
| | | | Min. | Typ. | Max. | |
| I _{RRM} | Repetitive reverse current | T _j =150°C, V _{RRM} applied | — | — | 2.0 | mA |
| V _{FM} | Forward voltage | T _j =25°C, I _{FM} =20A, instantaneous meas. | — | — | 1.25 | V |
| R _{th (j-c)} | Thermal resistance | Junction to case | — | — | 1.0 | °C/W |
| R _{th (c-f)} | Contact thermal resistance | Case to fin, conductive grease applied | — | — | 0.1 | °C/W |
| — | Insulation resistance | Measured with a 500V megohmmeter between main terminal and case | 10 | — | — | MΩ |

RM10TA-24,-2H

HIGH VOLTAGE MEDIUM POWER GENERAL USE
INSULATED TYPE

PERFORMANCE CURVES

MAXIMUM FORWARD CHARACTERISTIC

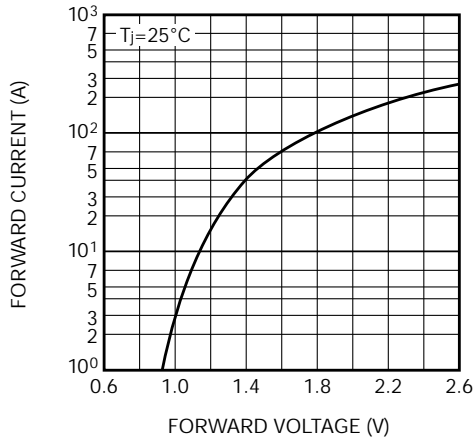

ALLOWABLE SURGE (NON-REPETITIVE) FORWARD CURRENT

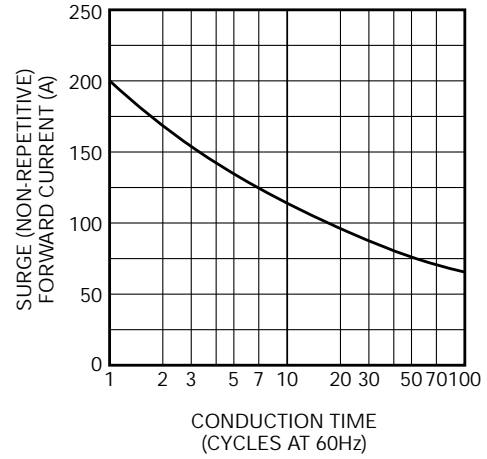

MAXIMUM TRANSIENT THERMAL IMPEDANCE (JUNCTION TO CASE)

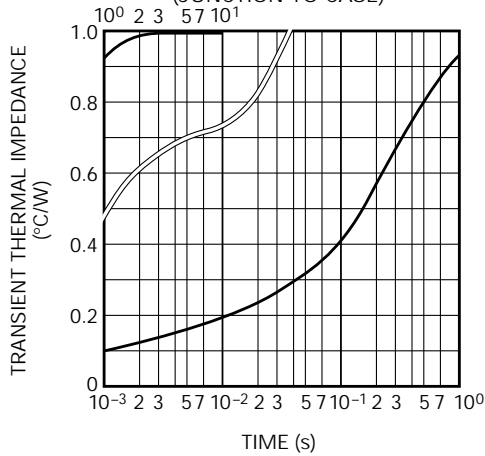

MAXIMUM POWER DISSIPATION

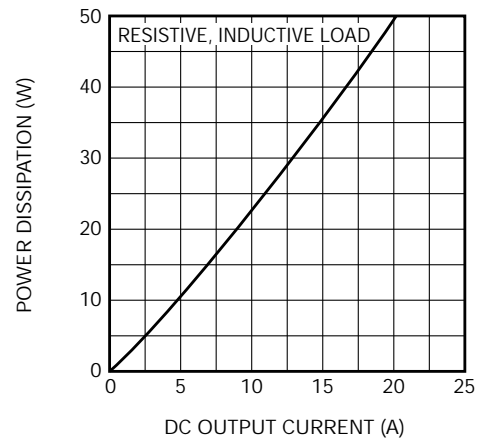

ALLOWABLE CASE TEMPERATURE VS. DC OUTPUT CURRENT

