

V23100-V4 series

Dual In-line Package and Single In-line Package Dry Reed Relays

Features

- DIP (flat and high) and SIP versions.
- For use in measuring and control systems.
- Direct coil control with TTL-signals.
- IC pin compatible.
- Low operating noises and low thermoelectric voltage.
- Ultrasonic cleanable.
- High vibration and shock resistance.

Contact Data @ 25°C

Type of Relay	DIP Version		SIP Version
Type of Contacts	SPST, 1 Form A DPST, 2 Form A	SPDT, 1 Form C	SPST, 1 Form A
Max. Switch. Current	0.5A	0.25A	0.5A
Max. Continuous Current	1A	1.2A	1A
Max. Switch. Voltage @ nominal voltage			
5VDC	180VDC/MAC	175VDC	180VDC/MAC
12-24VDC	200VDC/MAC		200VDC/MAC
Max. Switch. Capacity			
VDC	10W	3W	10W
VAC	10VA	3VA	10VA
Expected Mech. Life	5 Million Ops.	4 Million Ops.	5 Million Ops.
Initial Contact Resist.	150mΩ @ 10Ma/20mV		

Initial Dielectric Strength

Between Form A Contacts: 250VDC (12V-24V coils), 210VDC (5V coils).
 Form C Contacts: 200VDC.
 Between Coil and Contacts: 1,500VDC.

Initial Insulation Resistance

Between Mutually Insulated Conductors: 10¹¹ ohms @ 500VDC.

Coil Data @ 25°C

Nominal Voltage: 5 to 24VDC.
 Nominal Power: 50 - 288mW.
 Maximum Coil Power:
 Temperature Rise:
 Duty Cycle:

Coil Data @ 20°C

Nominal Voltage (VDC)	Resistance ± 10% (Ohms)	Operating Voltage (VDC)	
		(Min.)	(Max.)
DIP and SIP Version: SPST - 1 Form A			
5	500	3.5	22
12	1,000	8.4	33
15	2,000	10.5	44
24	2,000	16.8	44
DIP Version: DPST - 2 Form A			
5	200	3.5	14
12	500	8.4	25
15	2,000	10.5	47
24	2,000	16.8	47
DIP Version: SPDT -1 Form C			
5	200	3.5	13 (14.5)*
12	500	8.4	22 (23.5)*
15	2,000	10.5	44 (49.0)*
24	2,000	16.8	44 (49.0)*

*Values in brackets refer to high relay version with protective diode.

Operate Data @ 20°C

Must Operate Voltage: 70% of nominal voltage.
 Must Release Voltage: 15% of nominal voltage.

Type of Relay	DIP Version		SIP Version
Type of Contacts	SPST, 1 Form A DPST, 2 Form A	SPDT, 1 Form C	SPST, 1 Form A
Operate Time (Including Bounce)	0.5ms	0.7ms	0.5ms
Release Time (Including Bounce)	0.2ms	1.0ms	0.2ms

Operate Bounce:

Release Bounce:

Environmental Data

Temperature Range: -20°C to +70°C.
 Vibration, Operational:
 Shock, Operational:
 Shock, Non-destructive:

Mechanical Data

Termination:
 Enclosure:
 Weight:

Ordering Information

Typical Part Number ▶		V23100-V4	3	24	A	011
1. Basic Series: V23100-V4 – DIL and SIP reed relay.						
2. Version: DIP flat package: 0 – 1 Form A contacts. 3 – 1 Form C standard and 1 Form C with electrostatical shield. DIP high package: 3 – 2 Form A contacts and 1 Form C with diode or electrostatical shield and diode. SIP package: 5						
3. Coil Voltage: 05 – 5VDC 12 – 12VDC 15 – 15VDC 24 – 24VDC						
4. Contact Arrangement: A – 1 Form A (not for high DIP). B – 2 Form a (high DIP only). C – 1 Form C (not for SIP).						
5. Options: 000 – standard. 001 – with electrostatical shield 010 – with diode. 011 – with electrostatical shield and diode.						

Stock Items – The following items are normally maintained in stock for immediate delivery.

V23100V4005A000	V23100V4505A000
V23100V4012A000	V23100V4517A000
V23100V4024A000	V23100V4524A000

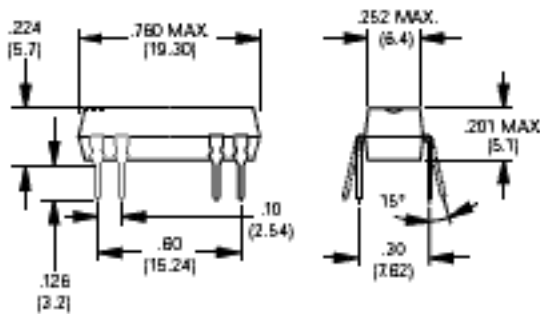
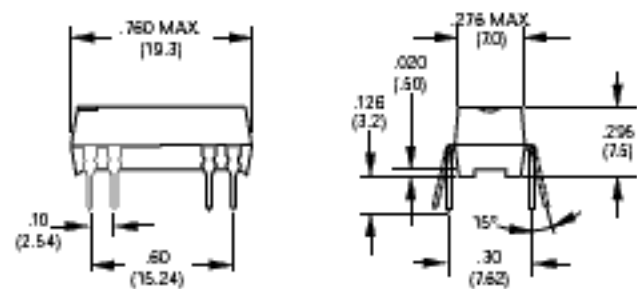
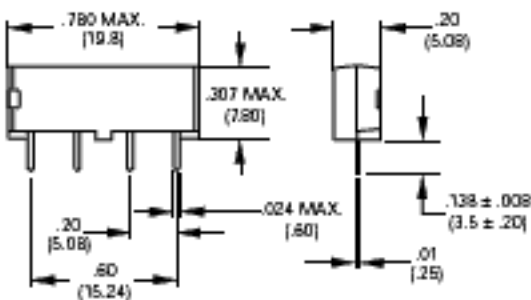
Outline Dimensions
DIP Version (Flat)

DIP Version (High)

SIP Version

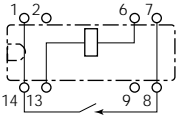
Wiring Diagrams (Bottom Views)
DIP Version (Flat)

SPST-1 Form A
standard

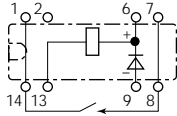

SPST-1 Form A
w/diode



SPDT-1 Form C
standard

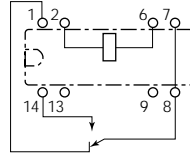

SPST-1 Form A
w/electrostatic Shield

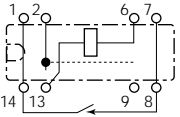

SPST-1 Form A
w/electrostatic shield and diode

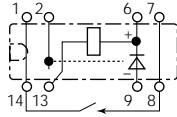

SPDT-1 Form C
w/electrostatic shield

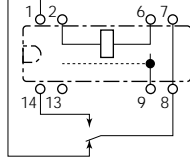

DIP Version (High)

DPST-2 Form A
standard

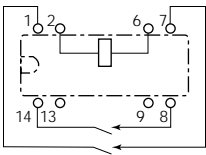

SPDT-1 Form C
w/diode

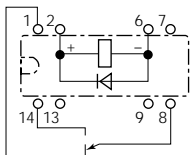

DPST-2 Form A
w/diode

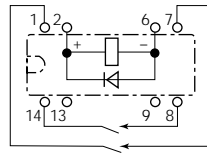

SPDT-1 Form C
w/electrostatic shield and diode

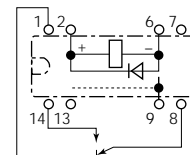

SIP Version

SPST-1 Form A
standard

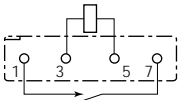

SPST-1 Form A
w/diode

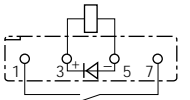

PC Board Layouts (Bottom Views)

DIP Version (Flat)

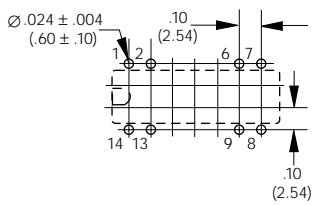

DIP Version (High)

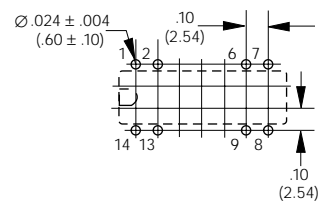

SIP Version

