

- ◆ P-Channel Power MOS FET
- ◆ DMOS Structure
- ◆ Low On-State Resistance : 0.045Ω (max)
- ◆ Ultra High-Speed Switching
- ◆ SOP - 8 Package

- Applications
 - Notebook PCs
 - Cellular and portable phones
 - On - board power supplies
 - Li - ion battery systems

■ General Description

The XP132A1545SR is a P-Channel Power MOS FET with low on-state resistance and ultra high-speed switching characteristics. Because high-speed switching is possible, the IC can be efficiently set thereby saving energy. The small SOP-8 package makes high density mounting possible.

■ Features

- Low on-state resistance** : $R_{ds(on)} = 0.03\Omega$ ($V_{gs} = -10V$)
 $R_{ds(on)} = 0.045\Omega$ ($V_{gs} = -4.5V$)
- Ultra high-speed switching**
- Operational Voltage** : $-4.5V$
- High density mounting** : SOP - 8

■ Pin Configuration

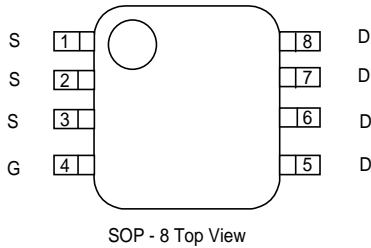

■ Pin Assignment

PIN NUMBER	PIN NAME	FUNCTION
1 - 3	S	Source
4	G	Gate
5 - 8	D	Drain

■ Equivalent Circuit

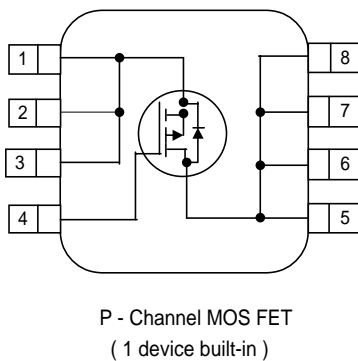

■ Absolute Maximum Ratings

$T_a = 25^\circ C$			
PARAMETER	SYMBOL	RATINGS	UNITS
Drain - Source Voltage	V_{dss}	-30	V
Gate - Source Voltage	V_{gss}	± 20	V
Drain Current (DC)	I_d	-8	A
Drain Current (Pulse)	I_{dp}	-32	A
Reverse Drain Current	I_{dr}	-8	A
Continuous Channel Power Dissipation (note)	P_d	2.5	W
Channel Temperature	T_{ch}	150	$^\circ C$
Storage Temperature	T_{stg}	-55 to 150	$^\circ C$

(note) : When implemented on a glass epoxy PCB

Electrical Characteristics

DC characteristics

Ta=25°C

PARAMETER	SYMBOL	CONDITIONS	MIN	TYP	MAX	UNITS
Drain Cut-off Current	Idss	Vds = - 30 , Vgs = 0V			- 10	μA
Gate-Source Leakage Current	Igss	Vgs = ± 20 , Vds = 0V			± 1	μA
Gate-Source Cut-off Voltage	Vgs (off)	Id = -1mA , Vds = - 10V	- 1.0		- 2.5	V
Drain-Source On-state Resistance (note)	Rds (on)	Id = - 4A , Vgs = - 10V		0.025	0.03	Ω
		Id = - 4A , Vgs = - 4.5V		0.038	0.045	Ω
Forward Transfer Admittance (note)	Yfs	Id = - 4A , Vds = - 10V		11		S
Body Drain Diode Forward Voltage	Vf	If = - 8A , Vgs = 0V		- 0.85	- 1.1	V

(note) : Effective during pulse test.

Dynamic characteristics

Ta=25°C

PARAMETER	SYMBOL	CONDITIONS	MIN	TYP	MAX	UNITS
Input Capacitance	Ciss	Vds = - 10V , Vgs = 0V f = 1 MHz		1500		pF
Output Capacitance	Coss			1000		pF
Feedback Capacitance	Crss			500		pF

Switching characteristics

Ta=25°C

PARAMETER	SYMBOL	CONDITIONS	MIN	TYP	MAX	UNITS
Turn-on Delay Time	td (on)	Vgs = - 5V , Id = - 4A Vdd = - 10V		20		ns
Rise Time	tr			45		ns
Turn-off Delay Time	td (off)			40		ns
Fall Time	tf			35		ns

Thermal characteristics

PARAMETER	SYMBOL	CONDITIONS	MIN	TYP	MAX	UNITS
Thermal Resistance (channel - surroundings)	Rth (ch - a)	Implement on a glass epoxy resin PCB		50		°C / W

Electrical Characteristics

Drain Current vs. Drain / Source Voltage

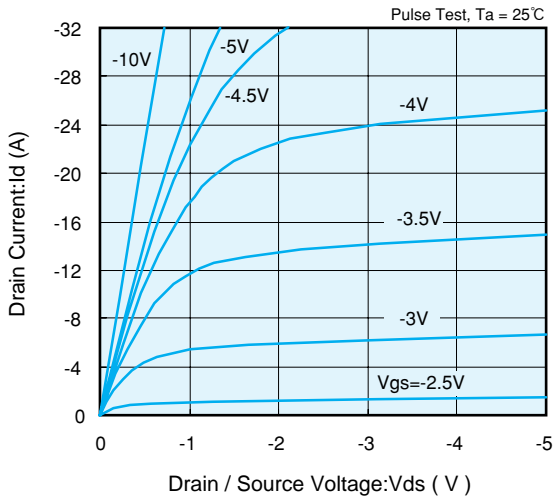

Drain Current vs. Gate / Source Voltage

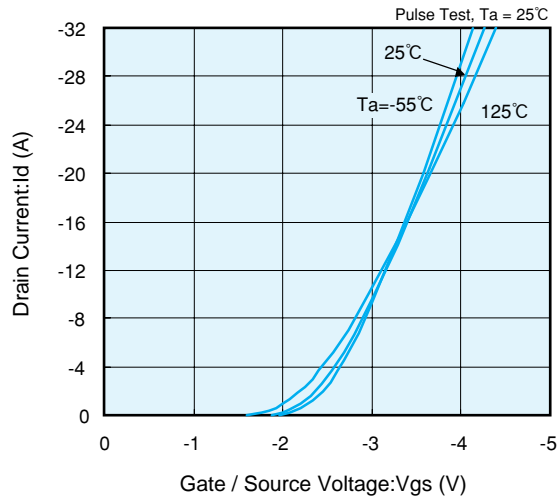

Drain / Source On-State Resistance vs. Gate / Source Voltage

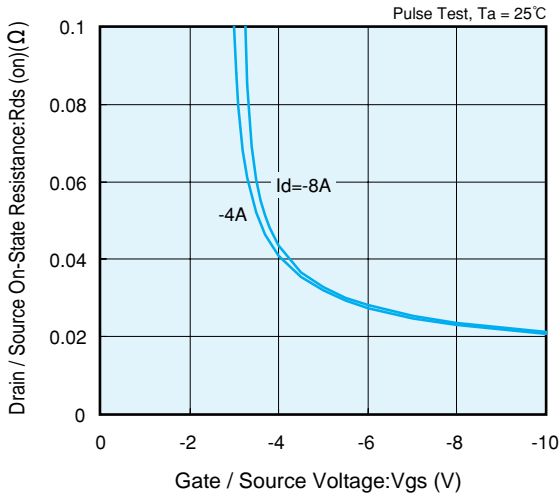

Drain / Source On-State Resistance vs. Drain Current

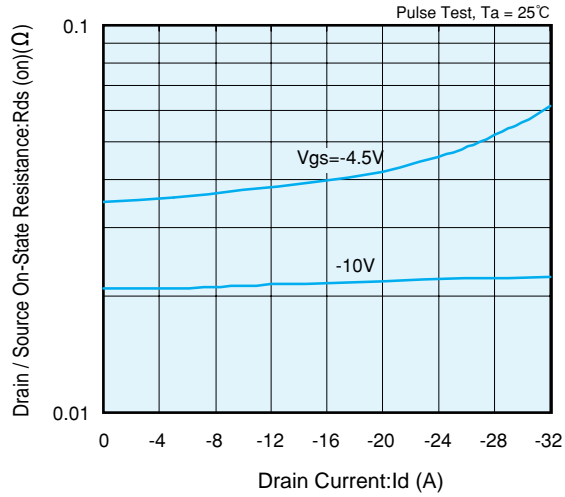

Drain / Source On-State Resistance vs. Ambient Temp.

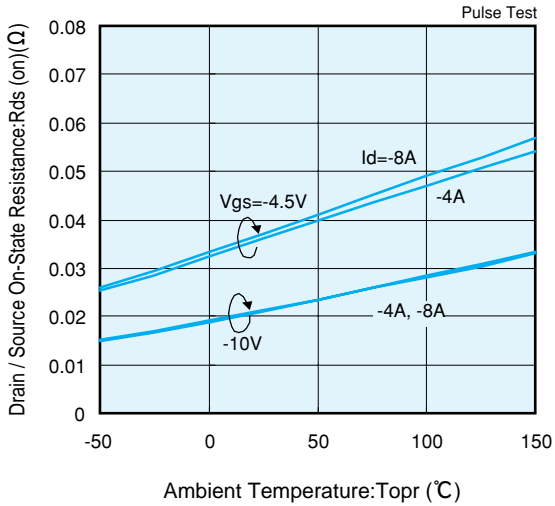

Gate / Source Cut Off Voltage Variance vs. Ambient Temp.

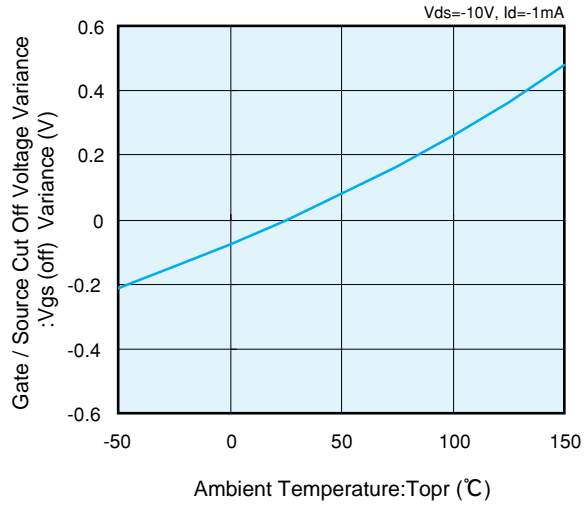

Electrical Characteristics

