

Thick film thermal printhead (11.8 dots / mm)

KF3008-GR10A

The KF3008-GR10A is a A4-size thick-film thermal printhead, developed mainly for handy printers for personal computers. The KF3008-GR10A is completely compatible with the KF2008-GR10A (200 dpi) in shape.

●Applications

Plain-paper printers
Low speed ticket vendors
Measuring terminal printers

●Features

- 1) A new pin connector structure greatly reduces the size and weight.
- 2) A newly developed 144-bit IC levels the strobe partition and reduces the noise level.
- 3) One rank resistance value of $3000 \Omega \pm 3\%$ eliminates the inconvenience of rank selection.
- 4) Thick film type with glazed components provides good printing quality on rough paper.

●External dimensions (Units: mm)

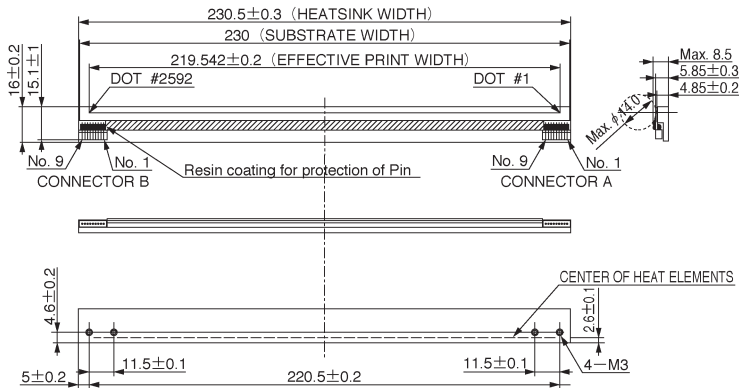

●Equivalent circuit

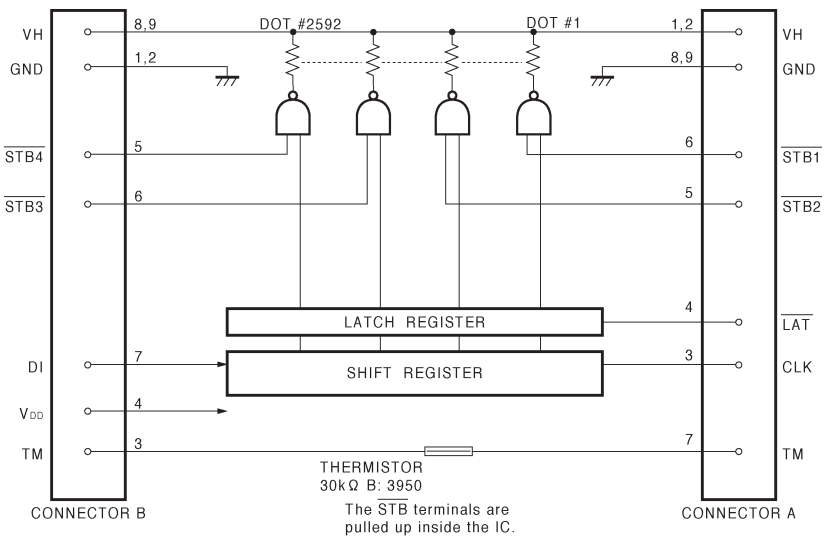

Fig. 1

●Pin assignments

CONNECTOR B	
No.	Circuit
1	GND
2	GND
3	TM
4	V _{DD}
5	STB4
6	STB3
7	DI
8	VH
9	VH

CONNECTOR A	
No.	Circuit
1	VH
2	VH
3	CLK
4	LAT
5	STB2
6	STB1
7	TM
8	GND
9	GND

●Timing chart

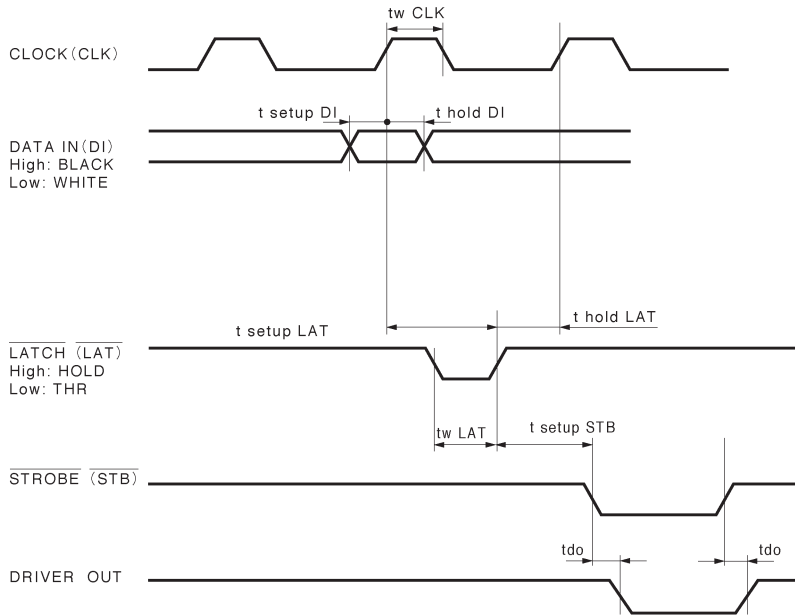

Fig. 2

●Characteristics

Parameter	Symbol	Typical	Unit
Effective printing width	—	219.542	mm
Dot pitch	—	0.0847	mm
Total dot number	—	2592	dots
Average resistance value	Rave	3000	Ω
Applied voltage	V _H	24.0	V
Applied power	P _O	0.16	W / dot
Print cycle	SLT	10	ms
Pulse width	T _{ON}	1.38	ms
Maximum number of dots energized simultaneously	—	720	dots
Maximum clock frequency	—	4	MHz
Maximum roller diameter	—	ϕ 14.0	mm
Running life / pulse life	—	20 / 3 × 10 ⁷	km / pulses
Operating temperature	—	5~45	°C

●Electrical characteristic curves

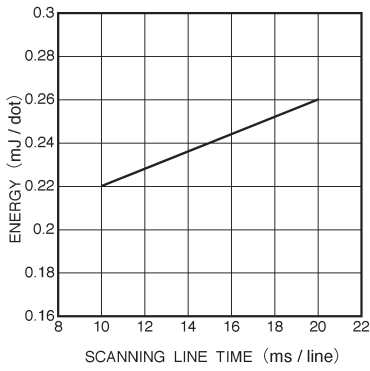

Fig. 3 Adaptive speed chart

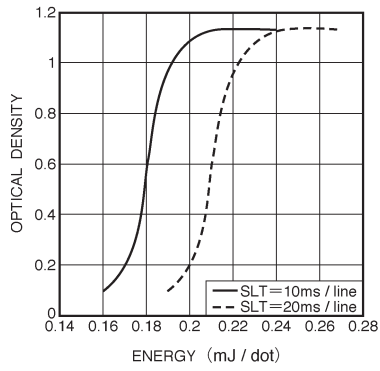

Fig. 4 Representative density curve

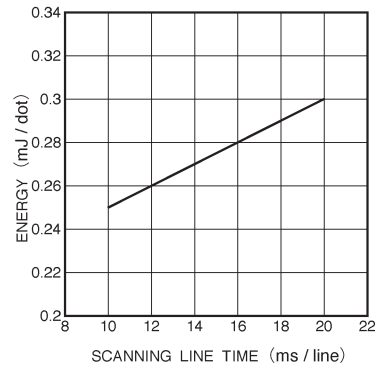

Fig. 5 Maximum energy curve

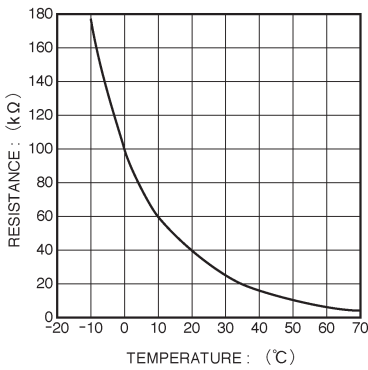

Fig. 6 Thermistor curve