

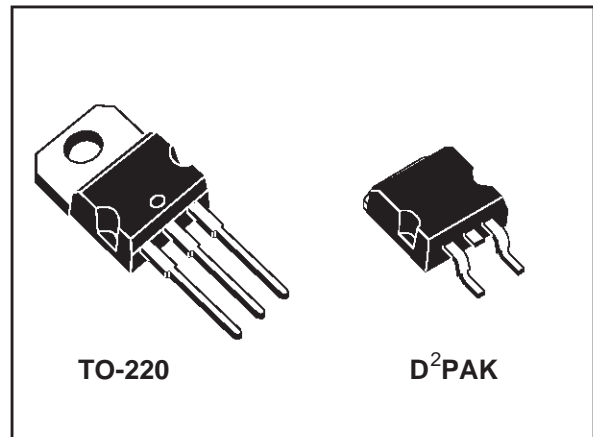

LD1086 SERIES

1.5A LOW DROP FIXED AND ADJUSTABLE POSITIVE VOLTAGE REGULATORS

- TYPICAL DROPOUT VOLTAGE 1.3V AT 1.5A
- THREE TERMINAL ADJUSTABLE OR FIXED OUTPUT VOLTAGE 1.8V, 2.5V, 2.85V, 3.3V, 3.6V, 5V, 8V, 9V, 12V
- GUARANTEED OUTPUT CURRENT UP TO 1.5A
- OUTPUT TOLERANCE $\pm 1\%$ AT 25°C AND $\pm 2\%$ IN FULL TEMPERATURE RANGE
- INTERNAL POWER AND THERMAL LIMIT
- WIDE OPERATING TEMPERATURE RANGE -40°C TO 125°C
- PACKAGE AVAILABLE: TO-220 D²PAK
- PINOUT COMPATIBILITY WITH STANDARD ADJUSTABLE VOLTAGE REGULATORS



DESCRIPTION

The LD1086 is a LOW DROP Voltage Regulator able to provide up to 1.5A of Output Current. Dropout is guaranteed at a maximum of 1.5V at the maximum output current, decreasing at lower loads. The LD1086 is a pin compatible with older 3-terminal adjustable regulators, but has better performances in term of drop and output tolerance. A 2.85V output version is suitable for SCSI-2 active termination. Unlike

PNP regulators, where a part of the output current is wasted as quiescent current, the LD1086 quiescent current flow into the load, so increase efficiency. Only a $10\ \mu\text{F}$ minimum capacitor is needed for stability. The device is supplied in TO-220 and D²PAK packages. On chip trimming allows the regulator to reach a very tight output voltage tolerance, within $\pm 1\%$ at 25°C .

BLOCK DIAGRAM

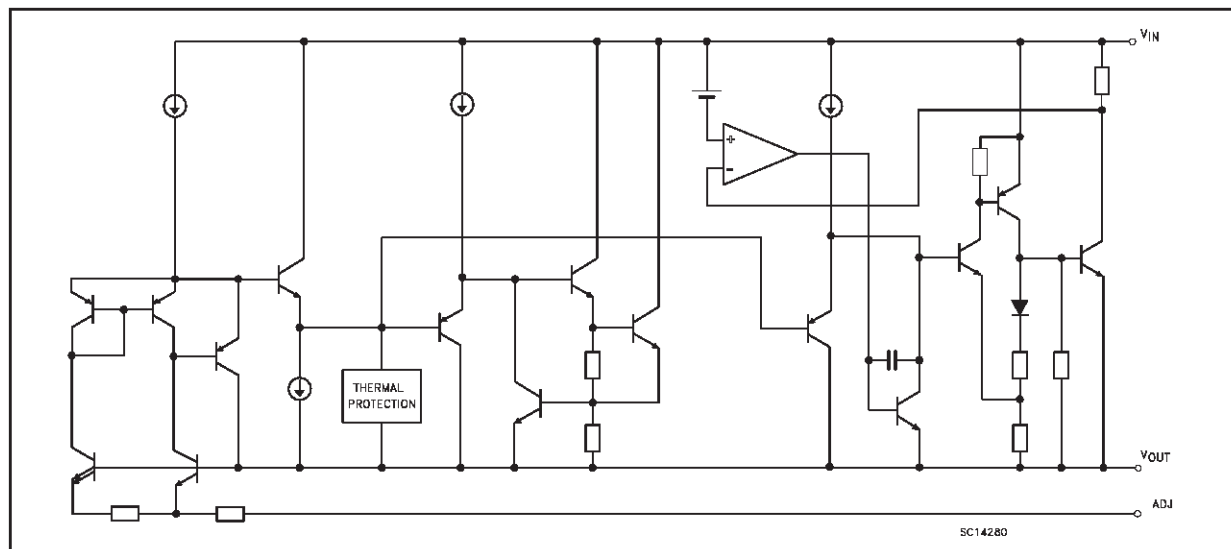

LD1086 SERIES

ABSOLUTE MAXIMUM RATINGS

Symbol	Parameter	Value	Unit
V_{IN}	DC Input Voltage	30	V
I_{OUT}	Output Current	Internally Limited	mA
P_{tot}	Power Dissipation	Internally Limited	mW
T_{stg}	Storage Temperature Range	-50 to 150	°C
T_{op}	Operating Junction Temperature Range	-40 to 125	°C

Absolute Maximum Ratings are those value beyond which damage to the device may occur. Functional operation under these condition is not implied. Over the above suggested Max Power Dissipation a Short Circuit could definitively damage the device.

THERMAL DATA

Symbol	Parameter	TO-220	D ² PAK	Unit
$R_{thj-case}$	Thermal Resistance Junction-case	3	3	°C/W
$R_{thj-amb}$	Thermal Resistance Junction-ambient	50	62.5	°C/W

APPLICATION CIRCUIT

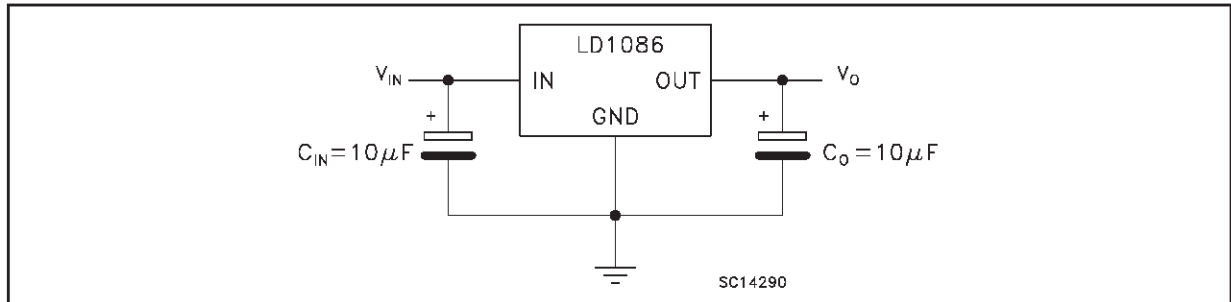

CONNECTION DIAGRAM AND ORDERING NUMBERS (top view)

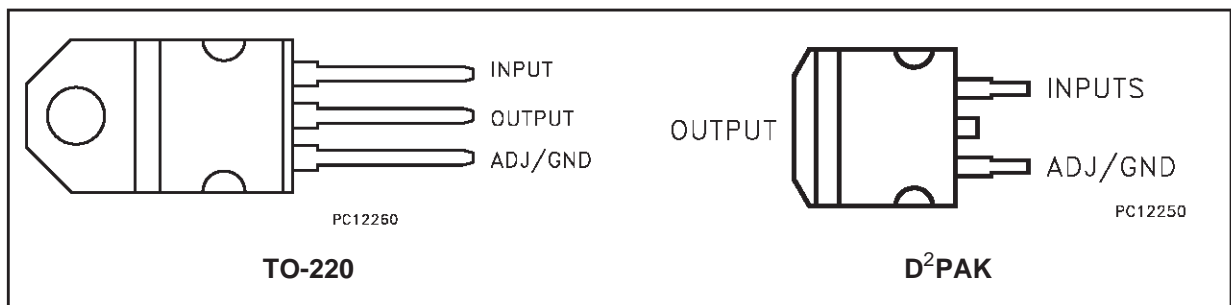

TO-220	D ² PAK (**)	Output Voltage
LD1086V18	LD1086D2T18	1.8V
LD1086V25	LD1086D2T25	2.5V
LD1086V28	LD1086D2T28	2.85V
LD1086V33	LD1086D2T33	3.3V
LD1086V36	LD1086D2T36	3.6V
LD1086V50	LD1086D2T50	5V
LD1086V80	LD1086D2T80	8V
LD1086V90	LD1086D2T90	9V
LD1086V120	LD1086D2T120	12V
LD1086V	LD1086D2T	ADJUSTABLE VERSION

(**) Available in Tape & Reel with the suffix "R" for fixed version and "-R" for adjustable version.

ELECTRICAL CHARACTERISTICS FOR LD1086#18 (refer to the test circuits,
 $T_j = -40$ to 125 °C, $V_{IN} = 4.8$ V, $C_{IN} = C_O = 10$ μ F unless otherwise specified)

Symbol	Parameter	Test Conditions	Min.	Typ.	Max.	Unit
V_O	Output Voltage	$I_O = 0$ mA $T_j = 25$ °C	1.782	1.8	1.818	V
V_O	Output Voltage (Note 1)	$I_O = 0$ to 1.5 A $V_{IN} = 3.4$ to 30 V	1.764	1.8	1.836	V
ΔV_O	Line Regulation	$V_{IN} = 3.4$ to 18 V $I_O = 0$ mA $T_j = 25$ °C		0.2	4	mV
ΔV_O	Line Regulation	$V_{IN} = 3.4$ to 18 V $I_O = 0$ mA		0.4	4	mV
ΔV_O	Load Regulation	$I_O = 0$ to 1.5 A $T_j = 25$ °C		0.5	8	mV
ΔV_O	Load Regulation	$I_O = 0$ to 1.5 A		1	16	mV
V_d	Dropout Voltage	$I_O = 1.5$ A		1.3	1.5	V
I_d	Quiescent Current	$V_{IN} \leq 30$ V		5	10	mA
I_{sc}	Short Circuit Current	$V_{IN} - V_O = 5$ V	1.5	2		A
		$V_{IN} - V_O = 25$ V	0.05	0.2		
	Thermal Regulation	$T_a = 25$ °C 30ms Pulse		0.01	0.04	%/W
SVR	Supply Voltage Rejection	$I_O = 1.5$ A $f = 120$ Hz $C_O = 25$ μ F $V_{IN} = 6.8 \pm 3$ V	60	82		dB
eN	Output Noise Voltage	$B = 10$ Hz to 10 KHz $T_a = 25$ °C		0.003		%
S	Temperature Stability			0.5		%
S	Long Term Stability	1000 hrs $T_a = 125$ °C		0.5		%

Note1: See short-circuit curve for available output current at fixed dropout.

ELECTRICAL CHARACTERISTICS FOR LD1086#25 (refer to the test circuits,
 $T_j = -40$ to 125 °C, $V_{IN} = 5.5$ V, $C_{IN} = C_O = 10$ μ F unless otherwise specified)

Symbol	Parameter	Test Conditions	Min.	Typ.	Max.	Unit
V_O	Output Voltage	$I_O = 0$ mA $T_j = 25$ °C	2.475	2.5	2.525	V
V_O	Output Voltage (Note 1)	$I_O = 0$ to 1.5 A $V_{IN} = 4.1$ to 30 V	2.45	2.5	2.55	V
ΔV_O	Line Regulation	$V_{IN} = 4.1$ to 18 V $I_O = 0$ mA $T_j = 25$ °C		0.2	5	mV
ΔV_O	Line Regulation	$V_{IN} = 4.1$ to 18 V $I_O = 0$ mA		0.4	5	mV
ΔV_O	Load Regulation	$I_O = 0$ to 1.5 A $T_j = 25$ °C		0.5	10	mV
ΔV_O	Load Regulation	$I_O = 0$ to 1.5 A		1	18	mV
V_d	Dropout Voltage	$I_O = 1.5$ A		1.3	1.5	V
I_d	Quiescent Current	$V_{IN} \leq 30$ V		5	10	mA
I_{sc}	Short Circuit Current	$V_{IN} - V_O = 5$ V	1.5	2		A
		$V_{IN} - V_O = 25$ V	0.05	0.2		
	Thermal Regulation	$T_a = 25$ °C 30ms Pulse		0.01	0.04	%/W
SVR	Supply Voltage Rejection	$I_O = 1.5$ A $f = 120$ Hz $C_O = 25$ μ F $V_{IN} = 7.5 \pm 3$ V	60	81		dB
eN	Output Noise Voltage	$B = 10$ Hz to 10 KHz $T_a = 25$ °C		0.003		%
S	Temperature Stability			0.5		%
S	Long Term Stability	1000 hrs $T_a = 125$ °C		0.5		%

Note1: See short-circuit curve for available output current at fixed dropout.

LD1086 SERIES

ELECTRICAL CHARACTERISTICS FOR LD1086#285 (refer to the test circuits,
 $T_j = -40$ to 125 °C, $V_{IN} = 5.85$ V, $C_{IN} = C_O = 10$ μ F unless otherwise specified)

Symbol	Parameter	Test Conditions	Min.	Typ.	Max.	Unit
V_O	Output Voltage	$I_O = 0$ mA $T_j = 25$ °C	2.821	2.85	2.879	V
V_O	Output Voltage (Note 1)	$I_O = 0$ to 1.5 A $V_{IN} = 4.5$ to 30 V	2.793	2.85	2.907	V
ΔV_O	Line Regulation	$V_{IN} = 4.5$ to 18 V $I_O = 0$ mA $T_j = 25$ °C		0.2	6	mV
ΔV_O	Line Regulation	$V_{IN} = 4.5$ to 18 V $I_O = 0$ mA		0.5	6	mV
ΔV_O	Load Regulation	$I_O = 0$ to 1.5 A $T_j = 25$ °C		1	12	mV
ΔV_O	Load Regulation	$I_O = 0$ to 1.5 A		2	20	mV
V_d	Dropout Voltage	$I_O = 1.5$ A		1.3	1.5	V
I_d	Quiescent Current	$V_{IN} \leq 30$ V		5	10	mA
I_{SC}	Short Circuit Current	$V_{IN} - V_O = 5$ V	1.5	2		A
		$V_{IN} - V_O = 25$ V	0.05	0.2		
	Thermal Regulation	$T_a = 25$ °C 30ms Pulse		0.01	0.04	%/W
SVR	Supply Voltage Rejection	$I_O = 1.5$ A $f = 120$ Hz $C_O = 25\mu$ F $V_{IN} = 7.85 \pm 3$ V	60	80		dB
eN	Output Noise Voltage	$B = 10$ Hz to 10 KHz $T_a = 25$ °C		0.003		%
S	Temperature Stability			0.5		%
S	Long Term Stability	1000 hrs $T_a = 125$ °C		0.5		%

Note1: See short-circuit curve for available output current at fixed dropout.

ELECTRICAL CHARACTERISTICS FOR LD1086#33 (refer to the test circuits,
 $T_j = -40$ to 125 °C, $V_{IN} = 6.3$ V, $C_{IN} = C_O = 10$ μ F unless otherwise specified)

Symbol	Parameter	Test Conditions	Min.	Typ.	Max.	Unit
V_O	Output Voltage	$I_O = 0$ mA $T_j = 25$ °C	3.267	3.3	3.333	V
V_O	Output Voltage (Note 1)	$I_O = 0$ to 1.5 A $V_{IN} = 4.9$ to 30 V	3.234	3.3	3.366	V
ΔV_O	Line Regulation	$V_{IN} = 4.9$ to 18 V $I_O = 0$ mA $T_j = 25$ °C		0.5	10	mV
ΔV_O	Line Regulation	$V_{IN} = 4.9$ to 18 V $I_O = 0$ mA		1	10	mV
ΔV_O	Load Regulation	$I_O = 0$ to 1.5 A $T_j = 25$ °C		3	15	mV
ΔV_O	Load Regulation	$I_O = 0$ to 1.5 A		7	25	mV
V_d	Dropout Voltage	$I_O = 1.5$ A		1.3	1.5	V
I_d	Quiescent Current	$V_{IN} \leq 30$ V		5	10	mA
I_{SC}	Short Circuit Current	$V_{IN} - V_O = 5$ V	1.5	2		A
		$V_{IN} - V_O = 25$ V	0.05	0.2		
	Thermal Regulation	$T_a = 25$ °C 30ms Pulse		0.01	0.04	%/W
SVR	Supply Voltage Rejection	$I_O = 1.5$ A $f = 120$ Hz $C_O = 25\mu$ F $V_{IN} = 8.3 \pm 3$ V	60	79		dB
eN	Output Noise Voltage	$B = 10$ Hz to 10 KHz $T_a = 25$ °C		0.003		%
S	Temperature Stability			0.5		%
S	Long Term Stability	1000 hrs $T_a = 125$ °C		0.5		%

Note1: See short-circuit curve for available output current at fixed dropout.

ELECTRICAL CHARACTERISTICS FOR LD1086#36 (refer to the test circuits,
 $T_j = -40$ to 125 °C, $V_{IN} = 6.6$ V, $C_{IN} = C_O = 10$ μ F unless otherwise specified)

Symbol	Parameter	Test Conditions	Min.	Typ.	Max.	Unit
V_O	Output Voltage	$I_O = 0$ mA $T_j = 25$ °C	3.564	3.6	3.636	V
V_O	Output Voltage (Note 1)	$I_O = 0$ to 1.5 A $V_{IN} = 5.2$ to 30 V	3.528	3.6	3.672	V
ΔV_O	Line Regulation	$V_{IN} = 5.2$ to 18 V $I_O = 0$ mA $T_j = 25$ °C		0.5	10	mV
ΔV_O	Line Regulation	$V_{IN} = 5.2$ to 18 V $I_O = 0$ mA		1	10	mV
ΔV_O	Load Regulation	$I_O = 0$ to 1.5 A $T_j = 25$ °C		3	15	mV
ΔV_O	Load Regulation	$I_O = 0$ to 1.5 A		7	25	mV
V_d	Dropout Voltage	$I_O = 1.5$ A		1.3	1.5	V
I_d	Quiescent Current	$V_{IN} \leq 30$ V		5	10	mA
I_{SC}	Short Circuit Current	$V_{IN} - V_O = 5$ V $V_{IN} - V_O = 25$ V	1.5 0.05	2 0.2		A
	Thermal Regulation	$T_a = 25$ °C 30ms Pulse		0.01	0.04	%/W
SVR	Supply Voltage Rejection	$I_O = 1.5$ A $f = 120$ Hz $C_O = 25$ μ F $V_{IN} = 8.6 \pm 3$ V	60	78		dB
eN	Output Noise Voltage	$B = 10$ Hz to 10 KHz $T_a = 25$ °C		0.003		%
S	Temperature Stability			0.5		%
S	Long Term Stability	1000 hrs $T_a = 125$ °C		0.5		%

Note1: See short-circuit curve for available output current at fixed dropout.

ELECTRICAL CHARACTERISTICS FOR LD1086#50 (refer to the test circuits,
 $T_j = -40$ to 125 °C, $V_{IN} = 8$ V, $C_{IN} = C_O = 10$ μ F unless otherwise specified)

Symbol	Parameter	Test Conditions	Min.	Typ.	Max.	Unit
V_O	Output Voltage	$I_O = 0$ mA $T_j = 25$ °C	4.95	5	5.05	V
V_O	Output Voltage (Note 1)	$I_O = 0$ to 1.5 A $V_{IN} = 6.6$ to 30 V	4.9	5	5.1	V
ΔV_O	Line Regulation	$V_{IN} = 6.6$ to 20 V $I_O = 0$ mA $T_j = 25$ °C		0.5	10	mV
ΔV_O	Line Regulation	$V_{IN} = 6.6$ to 20 V $I_O = 0$ mA		1	10	mV
ΔV_O	Load Regulation	$I_O = 0$ to 1.5 A $T_j = 25$ °C		5	20	mV
ΔV_O	Load Regulation	$I_O = 0$ to 1.5 A		10	35	mV
V_d	Dropout Voltage	$I_O = 1.5$ A		1.3	1.5	V
I_d	Quiescent Current	$V_{IN} \leq 30$ V		5	10	mA
I_{SC}	Short Circuit Current	$V_{IN} - V_O = 5$ V $V_{IN} - V_O = 25$ V	1.5 0.05	2 0.2		A
	Thermal Regulation	$T_a = 25$ °C 30ms Pulse		0.01	0.04	%/W
SVR	Supply Voltage Rejection	$I_O = 1.5$ A $f = 120$ Hz $C_O = 25$ μ F $V_{IN} = 10 \pm 3$ V	60	75		dB
eN	Output Noise Voltage	$B = 10$ Hz to 10 KHz $T_a = 25$ °C		0.003		%
S	Temperature Stability			0.5		%
S	Long Term Stability	1000 hrs $T_a = 125$ °C		0.5		%

Note1: See short-circuit curve for available output current at fixed dropout.

LD1086 SERIES

ELECTRICAL CHARACTERISTICS FOR LD1086#80 (refer to the test circuits,
 $T_j = -40$ to 125 °C, $V_{IN} = 11$ V, $C_{IN} = C_O = 10$ μ F unless otherwise specified)

Symbol	Parameter	Test Conditions	Min.	Typ.	Max.	Unit
V_O	Output Voltage	$I_O = 0$ mA $T_j = 25$ °C	7.92	8	8.08	V
V_O	Output Voltage (Note 1)	$I_O = 0$ to 1.5 A $V_{IN} = 9.8$ to 30 V	7.84	8	8.16	V
ΔV_O	Line Regulation	$V_{IN} = 9.8$ to 20 V $I_O = 0$ mA $T_j = 25$ °C		1	18	mV
ΔV_O	Line Regulation	$V_{IN} = 9.8$ to 20 V $I_O = 0$ mA		2	18	mV
ΔV_O	Load Regulation	$I_O = 0$ to 1.5 A $T_j = 25$ °C		8	30	mV
ΔV_O	Load Regulation	$I_O = 0$ to 1.5 A		12	60	mV
V_d	Dropout Voltage	$I_O = 1.5$ A		1.3	1.5	V
I_d	Quiescent Current	$V_{IN} \leq 30$ V		5	10	mA
I_{sc}	Short Circuit Current	$V_{IN} - V_O = 5$ V	1.5	2		A
		$V_{IN} - V_O = 25$ V	0.05	0.2		
	Thermal Regulation	$T_a = 25$ °C 30ms Pulse		0.01	0.04	%/W
SVR	Supply Voltage Rejection	$I_O = 1.5$ A $f = 120$ Hz $C_O = 25$ μ F $V_{IN} = 13 \pm 3$ V	54	71		dB
eN	Output Noise Voltage	$B = 10$ Hz to 10 KHz $T_a = 25$ °C		0.003		%
S	Temperature Stability			0.5		%
S	Long Term Stability	1000 hrs $T_a = 125$ °C		0.5		%

Note1: See short-circuit curve for available output current at fixed dropout.

ELECTRICAL CHARACTERISTICS FOR LD1086#90 (refer to the test circuits,
 $T_j = -40$ to 125 °C, $V_{IN} = 12$ V, $C_{IN} = C_O = 10$ μ F unless otherwise specified)

Symbol	Parameter	Test Conditions	Min.	Typ.	Max.	Unit
V_O	Output Voltage	$I_O = 0$ mA $T_j = 25$ °C	8.91	9	9.09	V
V_O	Output Voltage (Note 1)	$I_O = 0$ to 1.5 A $V_{IN} = 11$ to 30 V	8.82	9	9.18	V
ΔV_O	Line Regulation	$V_{IN} = 11$ to 20 V $I_O = 0$ mA $T_j = 25$ °C		1	20	mV
ΔV_O	Line Regulation	$V_{IN} = 11$ to 20 V $I_O = 0$ mA		2	20	mV
ΔV_O	Load Regulation	$I_O = 0$ to 1.5 A $T_j = 25$ °C		8	30	mV
ΔV_O	Load Regulation	$I_O = 0$ to 1.5 A		12	60	mV
V_d	Dropout Voltage	$I_O = 1.5$ A		1.3	1.5	V
I_d	Quiescent Current	$V_{IN} \leq 30$ V		5	10	mA
I_{sc}	Short Circuit Current	$V_{IN} - V_O = 5$ V	1.5	2		A
		$V_{IN} - V_O = 25$ V	0.05	0.2		
	Thermal Regulation	$T_a = 25$ °C 30ms Pulse		0.01	0.04	%/W
SVR	Supply Voltage Rejection	$I_O = 1.5$ A $f = 120$ Hz $C_O = 25$ μ F $V_{IN} = 14 \pm 3$ V	54	70		dB
eN	Output Noise Voltage	$B = 10$ Hz to 10 KHz $T_a = 25$ °C		0.003		%
S	Temperature Stability			0.5		%
S	Long Term Stability	1000 hrs $T_a = 125$ °C		0.5		%

Note1: See short-circuit curve for available output current at fixed dropout.

ELECTRICAL CHARACTERISTICS FOR LD1086#120 (refer to the test circuits,
 $T_j = -40$ to 125 °C, $V_{IN} = 15$ V, $C_{IN} = C_O = 10$ μ F unless otherwise specified)

Symbol	Parameter	Test Conditions	Min.	Typ.	Max.	Unit
V_O	Output Voltage	$I_O = 0$ mA $T_j = 25$ °C	11.88	12	12.12	V
V_O	Output Voltage (Note 1)	$I_O = 0$ to 1.5 A $V_{IN} = 13.8$ to 30 V	11.76	12	12.24	V
ΔV_O	Line Regulation	$V_{IN} = 13.8$ to 25 V $I_O = 0$ mA $T_j = 25$ °C		1	25	mV
ΔV_O	Line Regulation	$V_{IN} = 13.8$ to 25 V $I_O = 0$ mA		2	25	mV
ΔV_O	Load Regulation	$I_O = 0$ to 1.5 A $T_j = 25$ °C		12	36	mV
ΔV_O	Load Regulation	$I_O = 0$ to 1.5 A		24	72	mV
V_d	Dropout Voltage	$I_O = 1.5$ A		1.3	1.5	V
I_d	Quiescent Current	$V_{IN} \leq 30$ V		5	10	mA
I_{SC}	Short Circuit Current	$V_{IN} - V_O = 5$ V	1.5	2		A
		$V_{IN} - V_O = 25$ V	0.05	0.2		
	Thermal Regulation	$T_a = 25$ °C 30ms Pulse		0.01	0.04	%/W
SVR	Supply Voltage Rejection	$I_O = 1.5$ A $f = 120$ Hz $C_{OUT} = 25$ μ F $V_{IN} = 17 \pm 3$ V	54	66		dB
eN	Output Noise Voltage	$B = 10$ Hz to 10 KHz $T_a = 25$ °C		0.003		%
S	Temperature Stability			0.5		%
S	Long Term Stability	1000 hrs $T_a = 125$ °C		0.5		%

Note1: See short-circuit curve for available output current at fixed dropout.

ELECTRICAL CHARACTERISTICS FOR LD1086 (refer to the test circuits,
 $T_j = -40$ to 125 °C, $V_{IN} = 4.75$ V, $C_I = C_O = 10$ μ F unless otherwise specified)

Symbol	Parameter	Test Conditions	Min.	Typ.	Max.	Unit
V_O	Output Voltage	$I_O = 10$ mA $T_j = 25$ °C	1.237	1.25	1.263	V
V_O	Output Voltage (Note 1)	$I_O = 0.01$ to 1.5 A $V_{IN} = 2.8$ to 30 V	1.225	1.25	1.275	V
ΔV_O	Line Regulation	$V_{IN} = 2.8$ to 16.5 V $I_O = 10$ mA $T_j = 25$ °C		0.015	0.2	%
ΔV_O	Line Regulation	$V_{IN} = 2.8$ to 16.5 V $I_O = 10$ mA		0.035	0.2	%
ΔV_O	Load Regulation	$I_O = 0.01$ to 1.5 A $T_j = 25$ °C		0.1	0.3	%
ΔV_O	Load Regulation	$I_O = 0.01$ to 1.5 A		0.2	0.4	%
V_d	Dropout Voltage	$I_O = 1.5$ A		1.3	1.5	V
$I_{O(min)}$	Minimum Load Current	$V_{IN} = 30$ V		3	10	mA
I_{SC}	Short Circuit Current	$V_{IN} - V_O = 5$ V	1.5	2		A
		$V_{IN} - V_O = 25$ V	0.05	0.2		
	Thermal Regulation	$T_a = 25$ °C 30ms Pulse		0.01	0.04	%/W
SVR	Supply Voltage Rejection	$I_O = 1.5$ A $f = 120$ Hz $C_{OUT} = 25$ μ F $C_{ADJ} = 25$ μ F $V_{IN} = 6.25 \pm 3$ V	60	88		dB
I_{ADJ}	Adjust pin Current	$I_O = 10$ mA $V_{IN} = 4.25$ V		40	120	μ A
ΔI_{ADJ}	Adjust pin Current Change	$V_{IN} = 2.8$ to 16.5 V $I_O = 0.01$ to 1.5 A		0.2	5	μ A
eN	Output Noise Voltage	$B = 10$ Hz to 10 KHz $T_a = 25$ °C		0.003		%
S	Temperature Stability			0.5		%
S	Long Term Stability	1000 hrs $T_a = 125$ °C		0.5		%

Note1: See short-circuit curve for available output current at fixed dropout.

LD1086 SERIES

TYPICAL CHARACTERISTICS (unless otherwise specified $T_J=125^\circ\text{C}$, $C_{IN}=C_O=10\mu\text{F}$)

Output Voltage vs Temperature

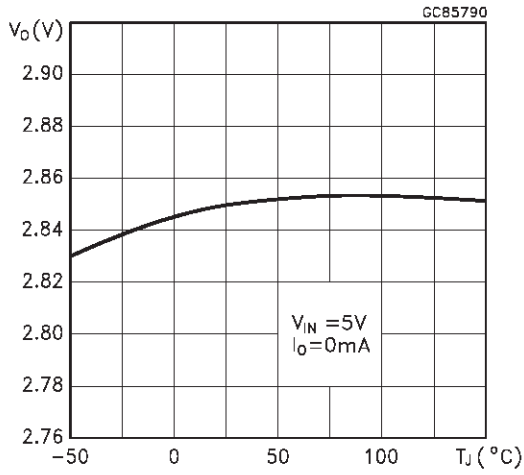

Output Voltage vs Temperature

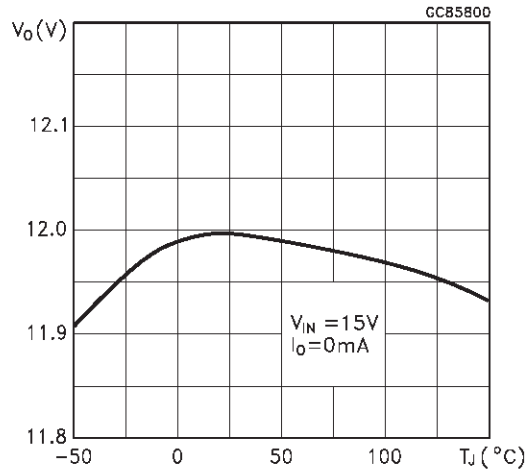

Output Voltage vs Temperature

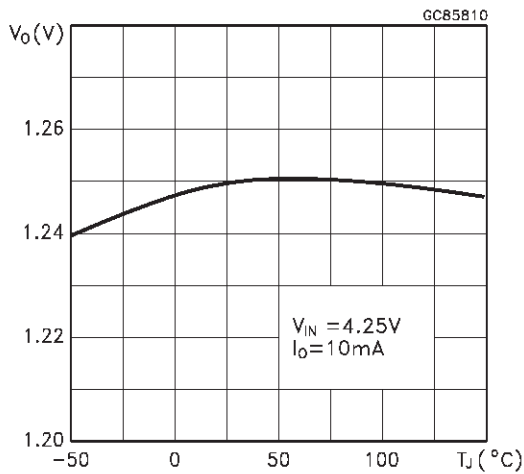

Short Circuit Current vs Dropout Voltage

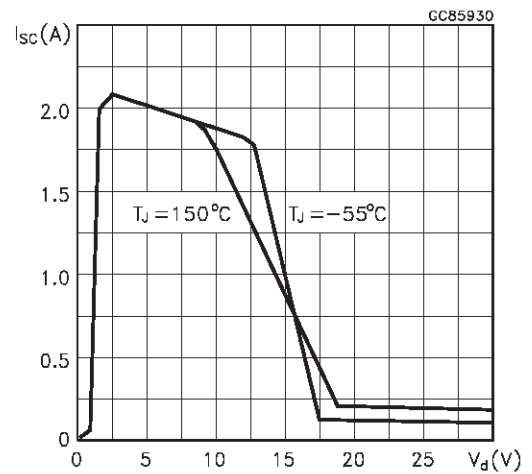

Line Regulation vs Temperature

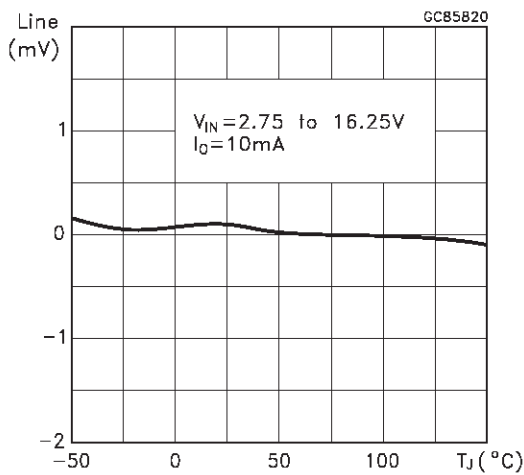

Load Regulation vs Temperature

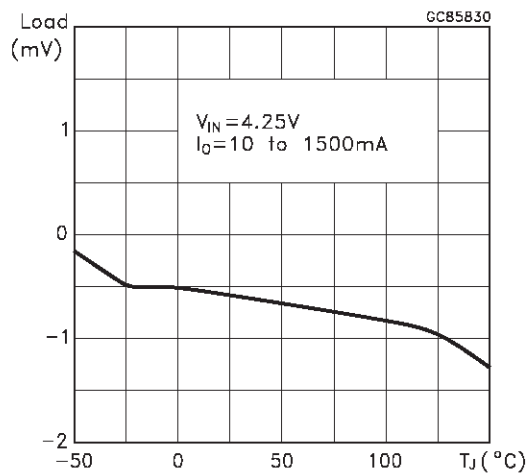

TYPICAL CHARACTERISTICS (Continued)

Dropout Voltage vs Temperature

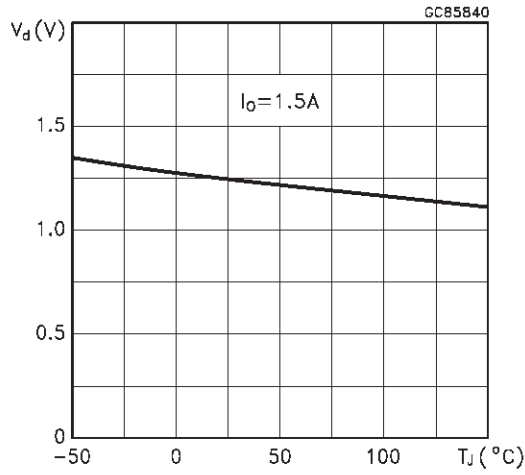

Dropout Voltage vs Output Current

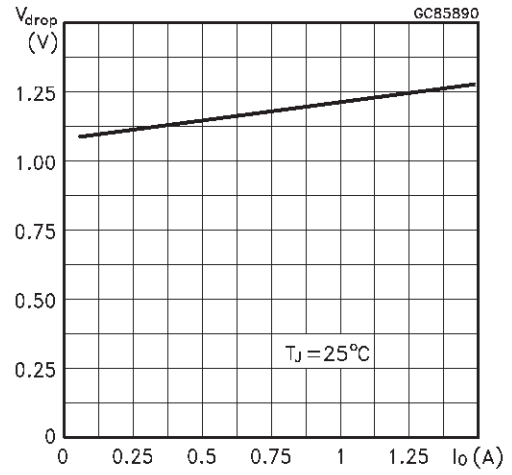

Adjust Pin Current vs Input Voltage

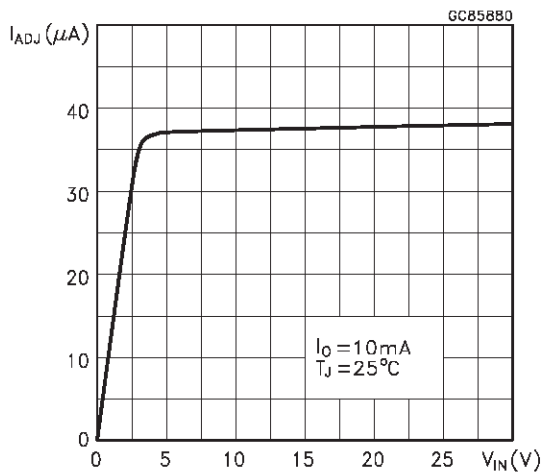

Adjust Pin Current vs Temperature

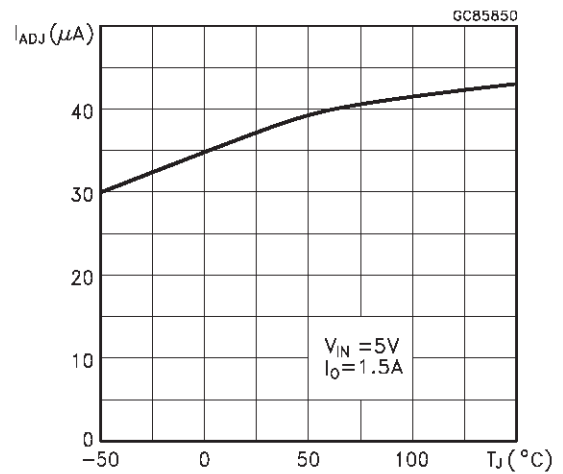

Adjust Pin Current vs Output Current

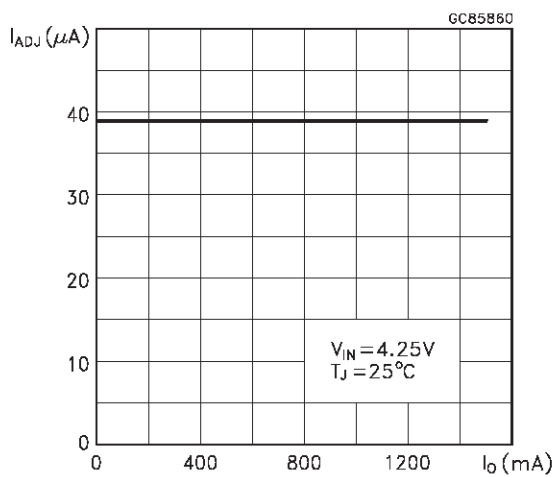

Quiescent Current vs Output Current

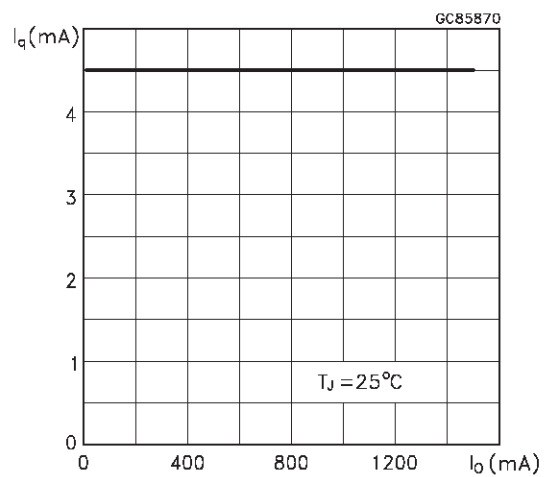

LD1086 SERIES

TYPICAL CHARACTERISTICS (Continued)

Quiescent Current vs Input Voltage

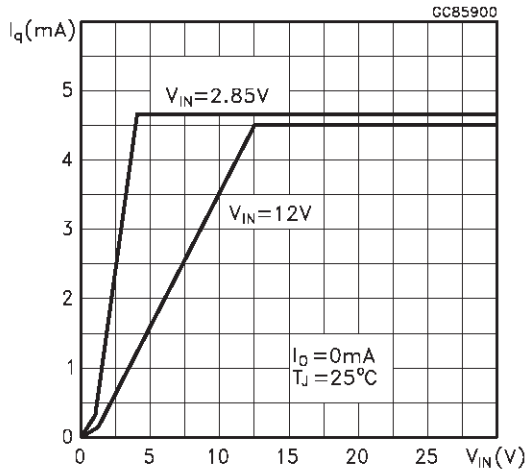

Supply Voltage Rejection vs Frequency

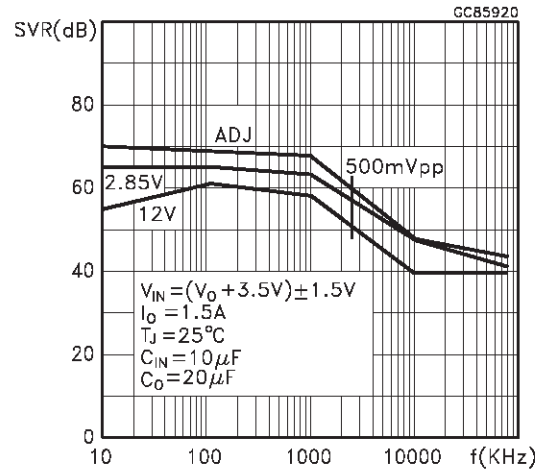

Supply Voltage Rejection vs Temperature

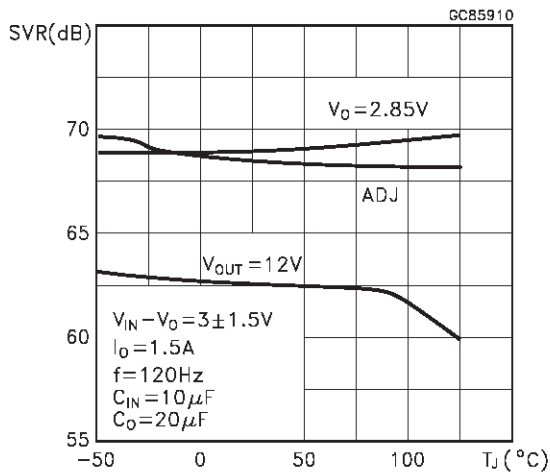

Supply Voltage Rejection vs Output Current

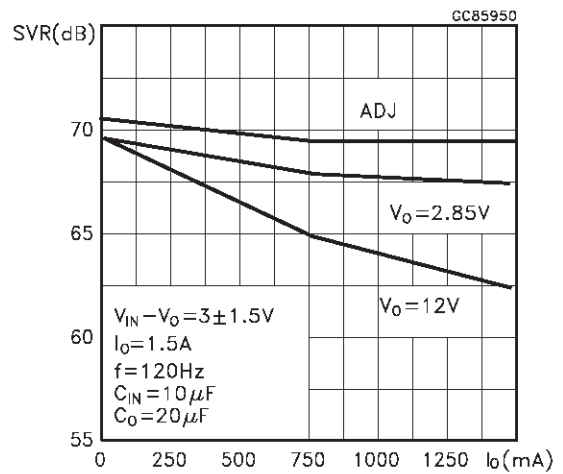

Minimum Load Current vs Temperature

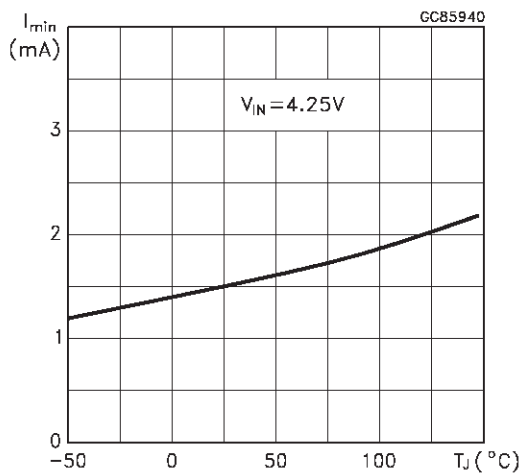

Stability for Adjustable

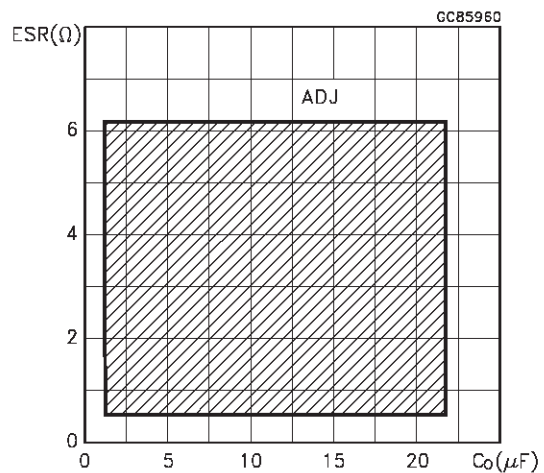

TYPICAL CHARACTERISTICS (Continued)

Stability for 2.85V

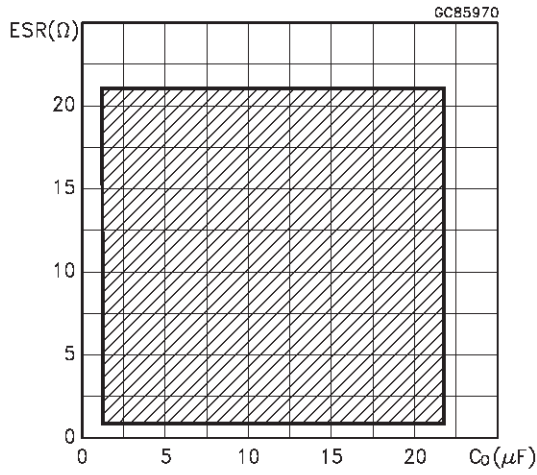

Stability for 12V

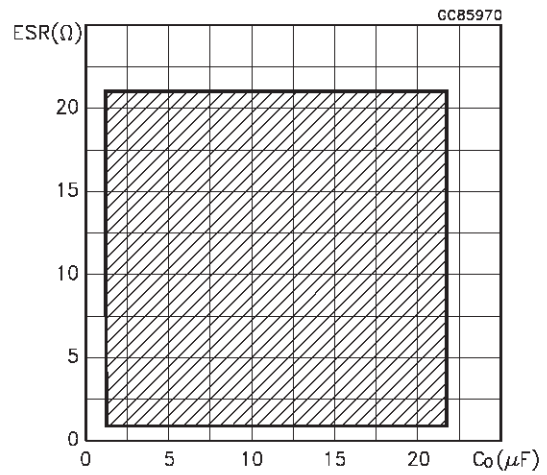

Line Transient

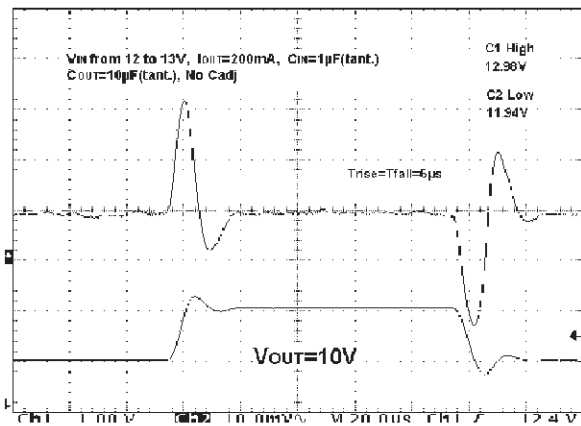

Line Transient

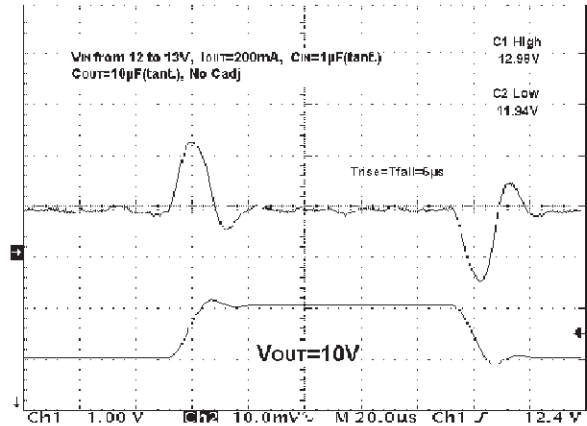

Line Transient

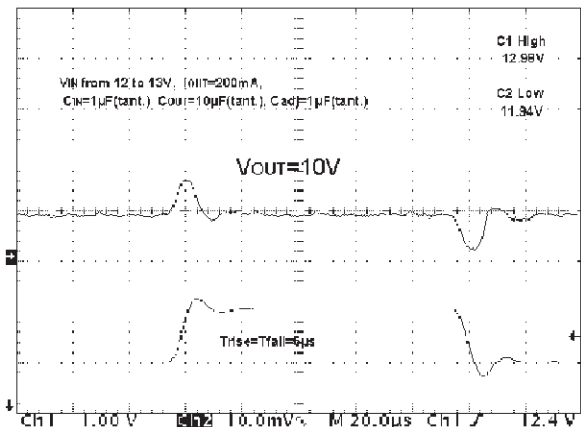

Load Transient

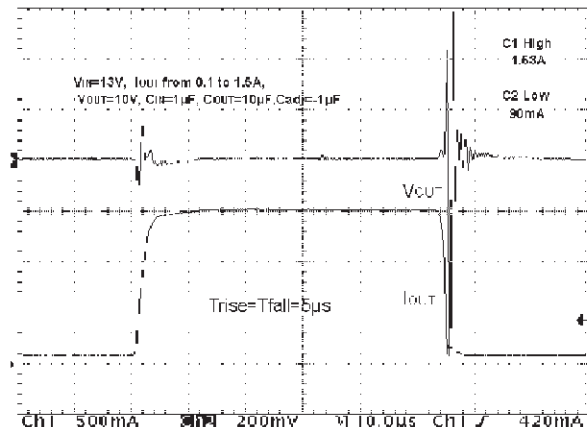

LD1086 SERIES

TYPICAL CHARACTERISTICS (Continued)

Load Transient

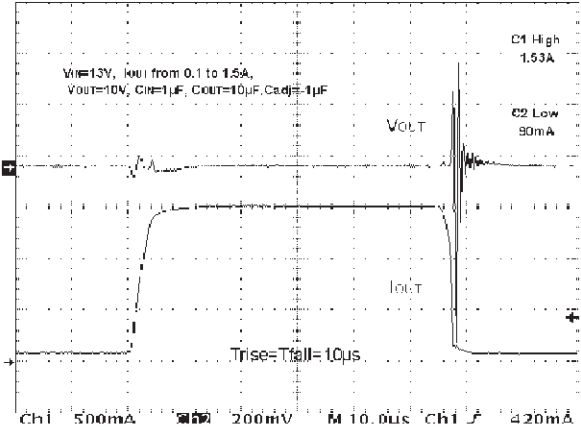

Thermal Protection

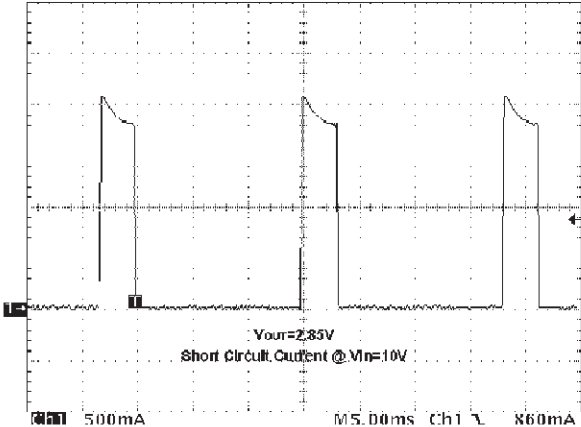

TO-220 MECHANICAL DATA

DIM.	mm			inch		
	MIN.	TYP.	MAX.	MIN.	TYP.	MAX.
A	4.40		4.60	0.173		0.181
C	1.23		1.32	0.048		0.051
D	2.40		2.72	0.094		0.107
D1		1.27			0.050	
E	0.49		0.70	0.019		0.027
F	0.61		0.88	0.024		0.034
F1	1.14		1.70	0.044		0.067
F2	1.14		1.70	0.044		0.067
G	4.95		5.15	0.194		0.203
G1	2.4		2.7	0.094		0.106
H2	10.0		10.40	0.393		0.409
L2		16.4			0.645	
L4	13.0		14.0	0.511		0.551
L5	2.65		2.95	0.104		0.116
L6	15.25		15.75	0.600		0.620
L7	6.2		6.6	0.244		0.260
L9	3.5		3.93	0.137		0.154
DIA.	3.75		3.85	0.147		0.151

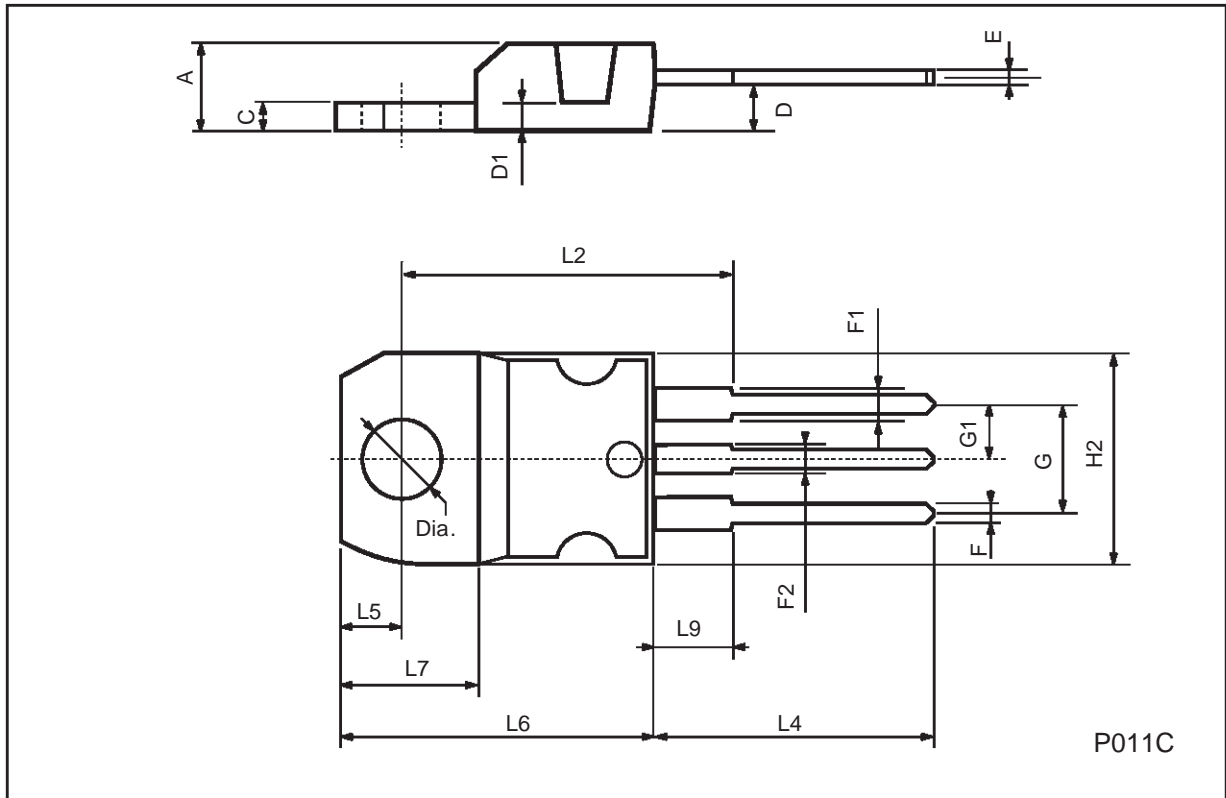

TO-263 (D²PAK) MECHANICAL DATA

DIM.	mm			inch		
	MIN.	TYP.	MAX.	MIN.	TYP.	MAX.
A	4.4		4.6	0.173		0.181
A1	2.49		2.69	0.098		0.106
B	0.7		0.93	0.027		0.036
B2	1.14		1.7	0.044		0.067
C	0.45		0.6	0.017		0.023
C2	1.21		1.36	0.047		0.053
D	8.95		9.35	0.352		0.368
E	10		10.4	0.393		0.409
G	4.88		5.28	0.192		0.208
L	15		15.85	0.590		0.624
L2	1.27		1.4	0.050		0.055
L3	1.4		1.75	0.055		0.068

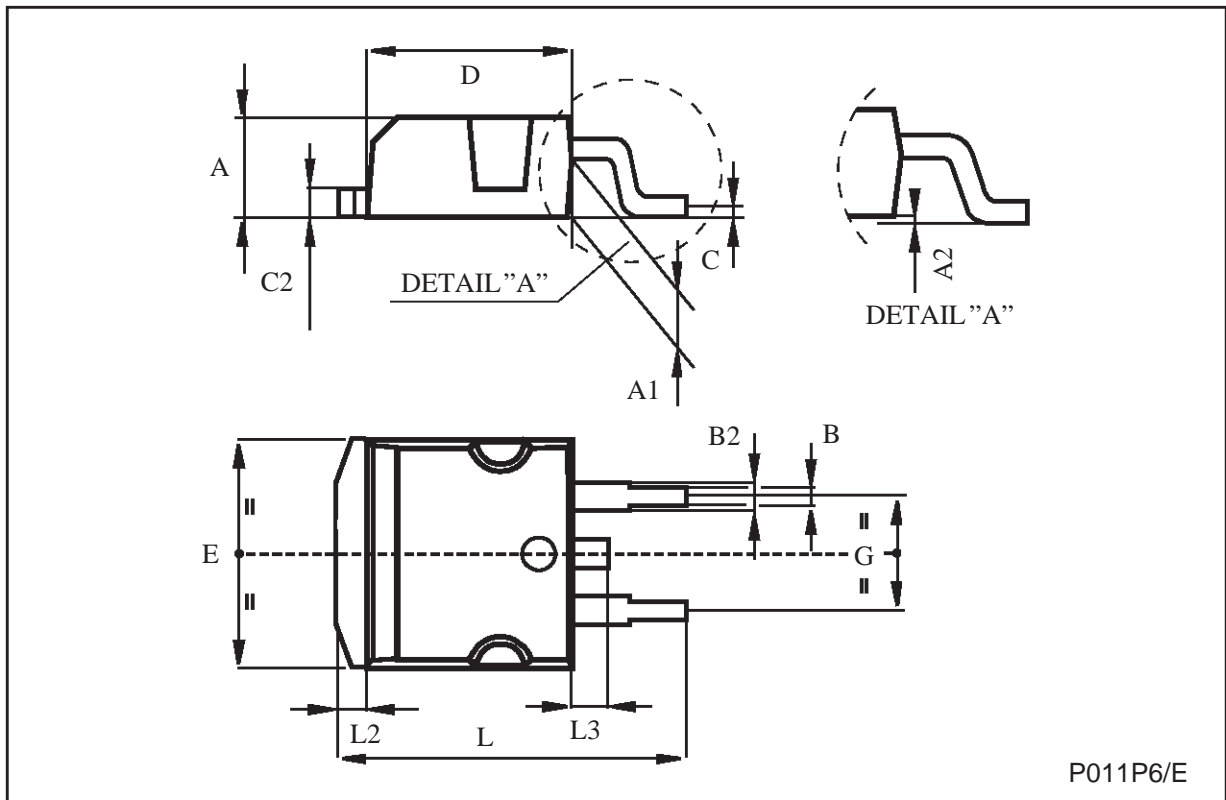

P011P6/E

Information furnished is believed to be accurate and reliable. However, STMicroelectronics assumes no responsibility for the consequences of use of such information nor for any infringement of patents or other rights of third parties which may result from its use. No license is granted by implication or otherwise under any patent or patent rights of STMicroelectronics. Specification mentioned in this publication are subject to change without notice. This publication supersedes and replaces all information previously supplied. STMicroelectronics products are not authorized for use as critical components in life support devices or systems without express written approval of STMicroelectronics.

The ST logo is a registered trademark of STMicroelectronics

© 1999 STMicroelectronics – Printed in Italy – All Rights Reserved

STMicroelectronics GROUP OF COMPANIES

Australia - Brazil - China - Finland - France - Germany - Hong Kong - India - Italy - Japan - Malaysia - Malta - Morocco
Singapore - Spain - Sweden - Switzerland - United Kingdom - U.S.A.

<http://www.st.com>