

# Low Noise Amplifier

## 1.7 - 2.0 GHz

# MAAM12032

### Features

- Low Noise Figure: 1.80 dB
- High Gain: 13 dB
- Low Power Consumption: 3 to 5 V, 5 mA
- High Dynamic Range
- DC Decoupled RF Input and Output
- No External RF Tuning Elements Necessary
- Low Cost SOIC 8 Plastic Package

### Description

M/A-COM's MAAM12032 is a high performance GaAs MMIC low noise amplifier in a low cost SOIC 8-lead surface mount plastic package. The MAAM12032 employs a fully monolithic design which eliminates the need for external tuning networks. It can be biased using 3- or 5-volt supplies and has an option for biasing at higher currents for increased dynamic range.

The MAAM12032 is ideally suited for use where low noise figure, high gain, high dynamic range and low power consumption are required. Typical applications include receiver front ends in the Japanese Personal Handy Phone Service (PHS), Private Branch Exchange (PBX) and Personal Communications Systems and Networks (PCS, PCN) markets, as well as standard gain blocks, buffer amps, driver amps and IF amps in both fixed and portable systems.

M/A-COM's MAAM12032 is fabricated using a mature 0.5-micron gate length GaAs process. The process features full passivation for increased performance reliability.

### SO-8

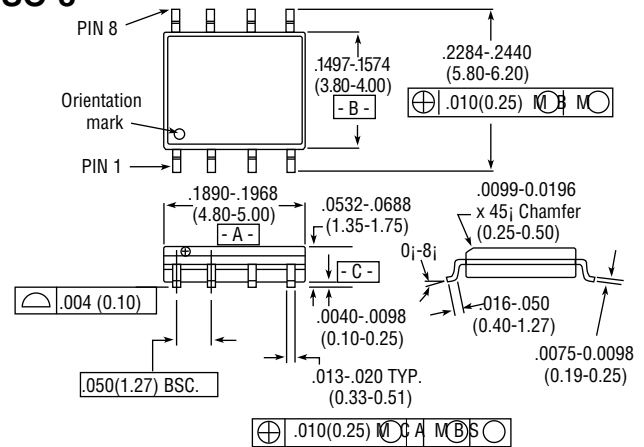

8-Lead SOP outline dimensions  
Narrow body .150  
(All dimensions per JEDEC No. MS-012-AA, Issue C)  
Dimensions in ( ) are in mm.  
Unless Otherwise Noted: .xxx = -0.010 (.xx = -0.25)  
.xx = -0.02 (.x = -0.5)

### Ordering Information

Part Number	Package
MAAM12032	SOIC 8-Lead Plastic
MAAM12032TR	Forward Tape and Reel*
MAAM12032RTR	Reverse Tape and Reel*
MAAM12032SMB	Designer's Kit

\* If specific reel size is required, consult factory for part number assignment.

### Electrical Specifications<sup>1</sup>, T<sub>A</sub> = +25°C, Z<sub>0</sub> = 50Ω, V<sub>DD</sub> = +5 V, P<sub>IN</sub> = -30 dBm, f = 1.7 - 2.0 GHz

Parameter	Units	Min.	Typ.	Max.
Gain	dB	10	13	16
Noise Figure	dB		1.8	2.1
Input VSWR			1.5:1	
Output VSWR			1.5:1	
Output 1 dB Compression	dBm		2	
Input IP <sub>3</sub>	dBm		0	
Reverse Isolation	dB		30	
Bias Current	mA	3	5	7

1. See following pages for 3-volt data.

**Absolute Maximum Ratings<sup>1</sup>**

Parameter	Absolute Maximum
V <sub>DD</sub>	+10 VDC
Input Power	+17 dBm
Current <sup>2</sup>	30 mA
Channel Temperature <sup>3</sup>	+150°C
Operating Temperature	-40°C to +85°C
Storage Temperature	-65°C to +150°C

1. Operation of this device outside these limits may cause permanent damage.
2. Only if pin #2 is used to increase current. (See note 6.)
3. Typical thermal resistance ( $\theta_{jc}$ ) = +165°C/W.

**Functional Diagram**

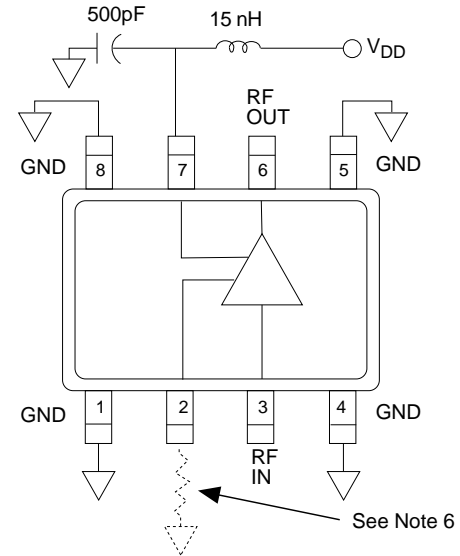

**Recommended PCB Configuration**

0.020 (0.51) FR-4 Circuit Board  
Dimensions in inches (mm)

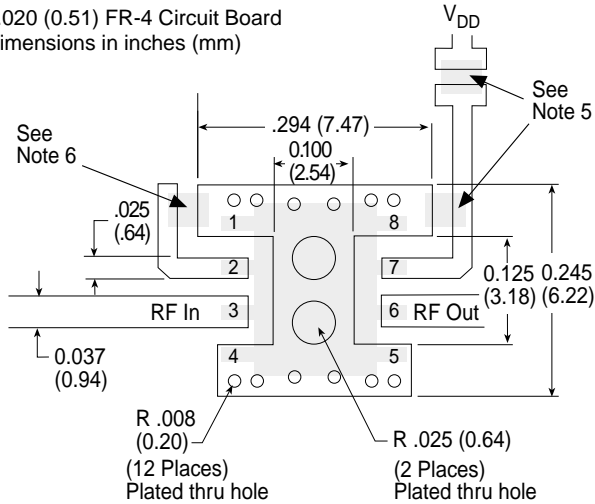

**Notes:**

4. Pins 1, 4, 5 and 8 must be RF and DC grounded as shown.
5. Pin 3 is the RF input; pin 6 is the RF output. V<sub>DD</sub> is applied on pin 7. This pin must be bypassed with a 500-pF surface mount MLC capacitor, mounted as close as possible to pin 7, and RF decoupled with a chip inductor having a minimum value of 15 nH (as shown in the Recommended PCB Configuration).
6. Pin 2 allows use of an external resistor to ground for optional, higher current bias. For nominal current operation no resistor is used. For optional 20-mA current operation, connect a 30- to 35-ohm chip resistor (as shown in the Recommended PCB Configuration).

**Typical Performance**

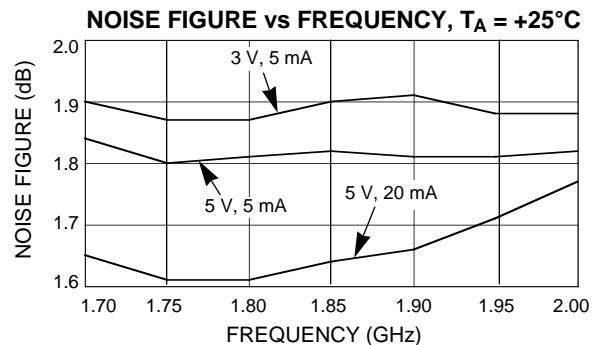
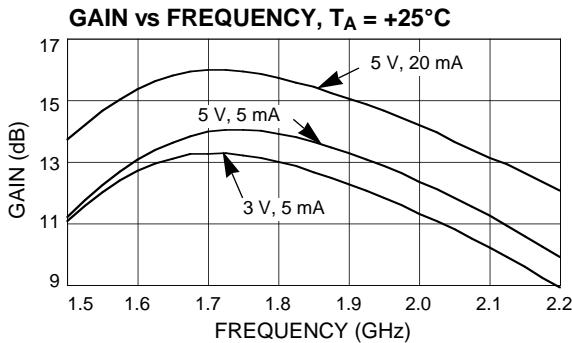

**VSWR vs FREQUENCY @ 5 V, 5 mA,  $T_A = +25^\circ\text{C}$**

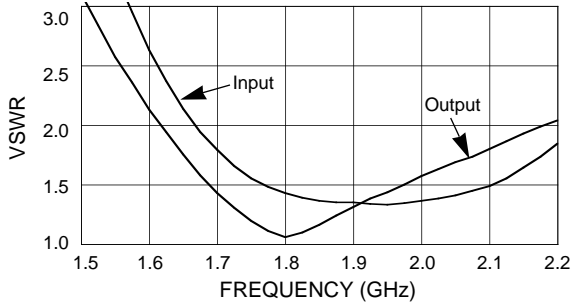

**INPUT  $IP_3$  vs FREQUENCY,  $T_A = +25^\circ\text{C}$**

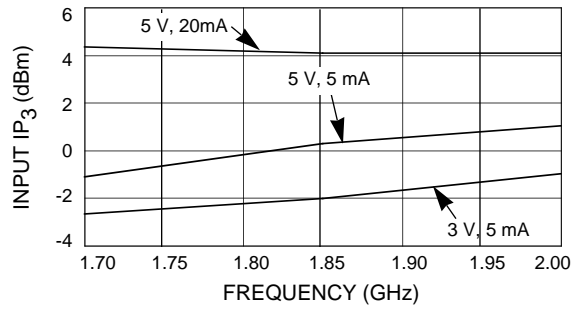

**GAIN vs FREQUENCY @ 5 V, 5 mA**

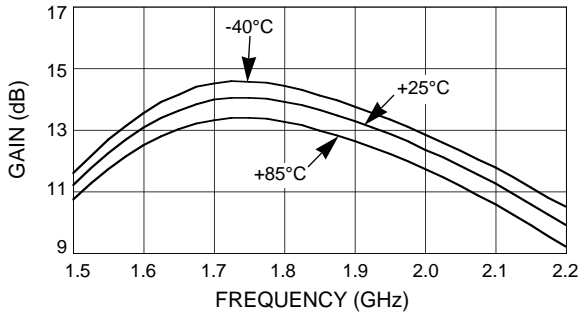

**NOISE FIGURE vs FREQUENCY @ 5 V, 5 mA**

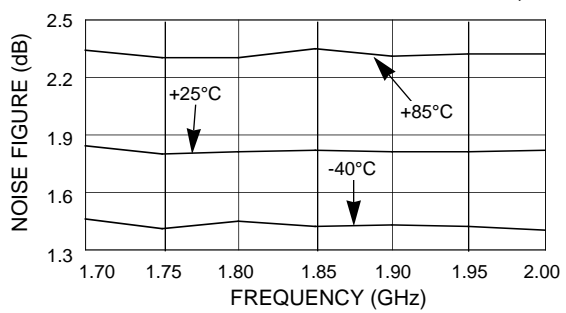

Additional information is available in Application Note M540, "M/A-COM GaAs MMIC LNA SOIC-8 Platform."