

## Product Description

Stanford Microdevices' SPA-2318 is a high efficiency GaAs Heterojunction Bipolar Transistor (HBT) amplifier housed in a low-cost surface-mountable plastic package. These HBT amplifiers are fabricated using molecular beam epitaxial growth technology which produces reliable and consistent performance from wafer to wafer and lot to lot.

This product is specifically designed for use as a driver amplifier for infrastructure equipment in the 2150 MHz PCS band. Its high linearity makes it an ideal choice for multi-carrier and digital applications.

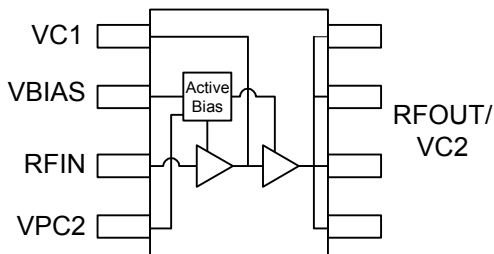

## SPA-2318

### 2150 MHz 1 Watt Power Amplifier with Active Bias

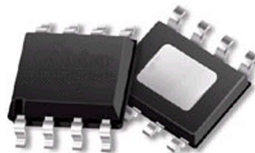

### Product Features

- **High Linearity Performance:**
  - +47 dBm Typ. OIP3 at 2140 MHz
  - +21.7 dBm W-CDMA Channel Power
  - at -45 dBc ACP
- **On-chip Active Bias Control**
- **High Gain: 23 dB Typ.**
- **Patented High Reliability GaAsHBT Technology**
- **Surface-Mountable Plastic Package**

### Applications

- **W-CDMA Systems**
- **Multi-Carrier Applications**

Symbol	Parameters: Test Conditions: $Z_0 = 50$ Ohms Temp = 25°C, $V_{cc}=5.0V$	Units	Min.	Typ.	Max.
$f_0$	Frequency of Operation	MHz	2110	2140	2170
$P_{1dB}$	Output Power at 1dB Compression	dBm		28	
$S_{21}$	Small Signal Gain	dB		23	
VSWR	Input VSWR	-		1.5:1	
$OIP_3$	Output Third Order Intercept Point Power out per tone = +14dBm	dBm		47	
NF	Noise Figure	dB		5.0	
$I_{cc}$	Device Current $I_{bias} = 10mA$ , $I_{c1} = 70mA$ , $I_{c2} = 320 mA$	mA		400	
$R_{thj-l}$	Thermal Resistance (junction - lead)	°C/W		32	

The information provided herein is believed to be reliable at press time. Stanford Microdevices assumes no responsibility for inaccuracies or omissions. Stanford Microdevices assumes no responsibility for the use of this information, and all such information shall be entirely at the user's own risk. Prices and specifications are subject to change without notice. No patent rights or licenses to any of the circuits described herein are implied or granted to any third party. Stanford Microdevices does not authorize or warrant any Stanford Microdevices product for use in life-support devices and/or systems. Copyright 2001 Stanford Microdevices, Inc. All worldwide rights reserved.

### 2140 MHz Application Circuit Data, Icc=400mA, T=+25C, Vcc=5V

Note: Tuned for Output IP3

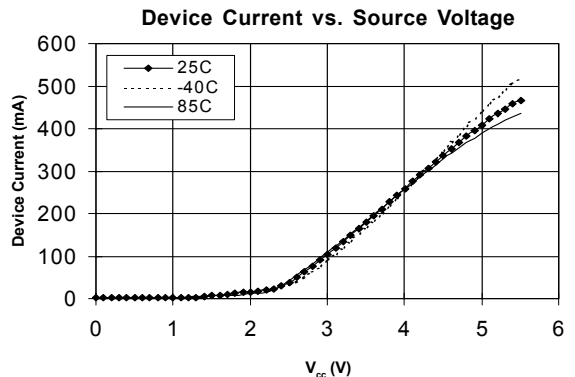
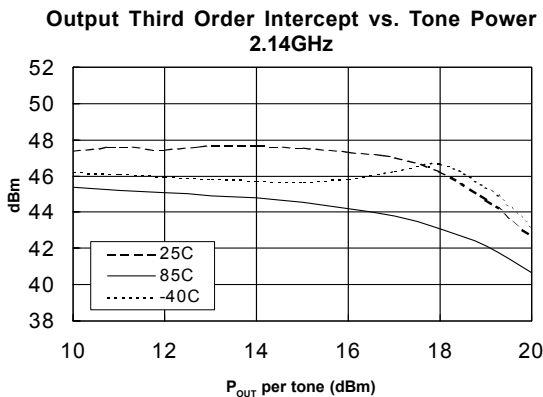
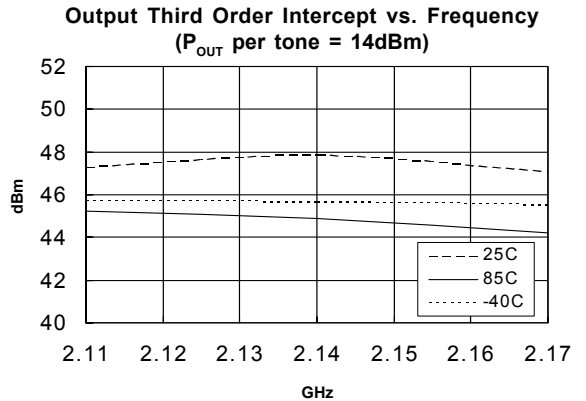
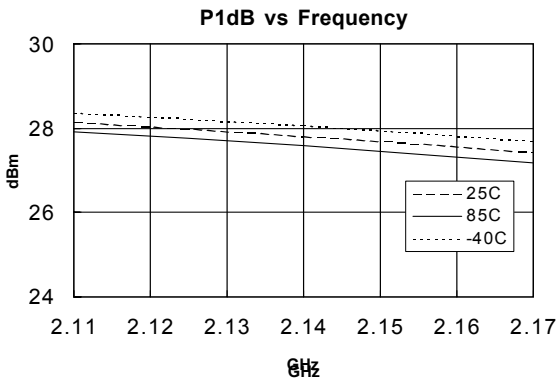
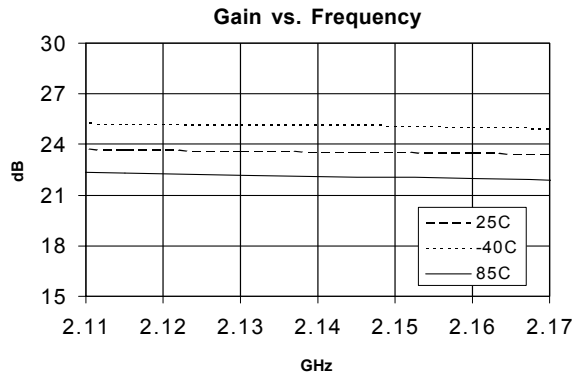
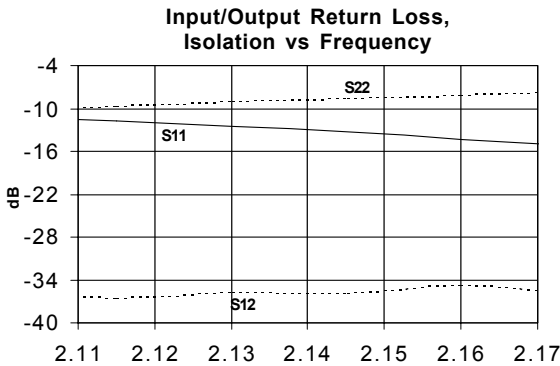

**2140 MHz Application Circuit Data, I<sub>cc</sub>=400mA, T=+25C, V<sub>cc</sub>=5V**  
 The W-CDMA setup is PCCPCH+PSCH+SSCH+CPICH+PICH+64 DPCH

**W-CDMA at 2.14 GHz Adjacent Channel Power vs. Channel Output Power**

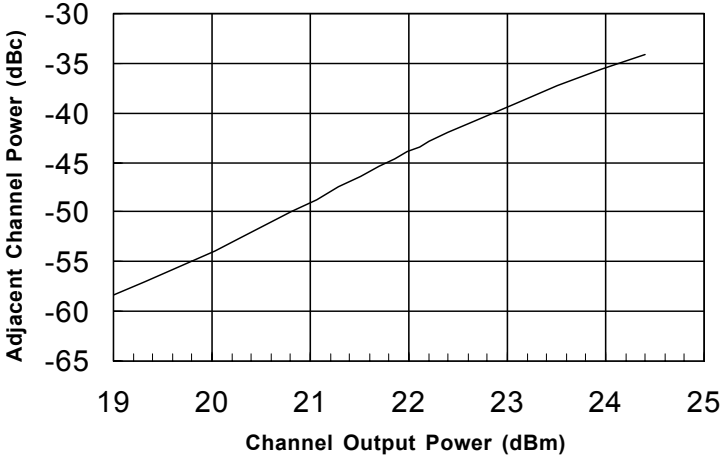

Frequency	2140 MHz
Small Signal Gain (dB)	23.4
Ch. Pwr. (dBm) @ -45 dBc ACP	21.7
Output IP3 (dBm)	45.4*
P1dB (dBm)	29.9

\*Note: IP3 performance degraded due to Device being tuned for optimal ACP performance

**W-CDMA at 2.14 GHz**

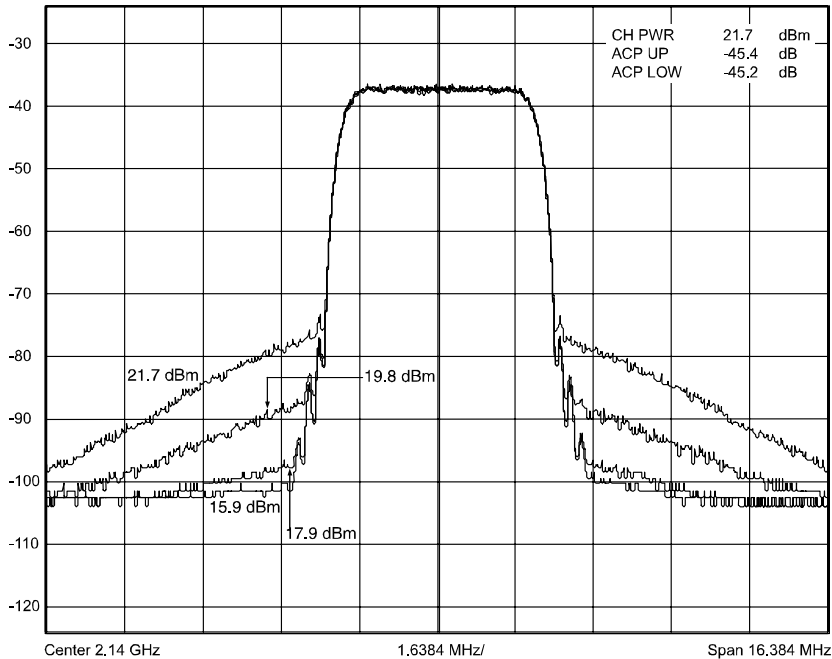

### 2110 - 2170 MHz Schematic

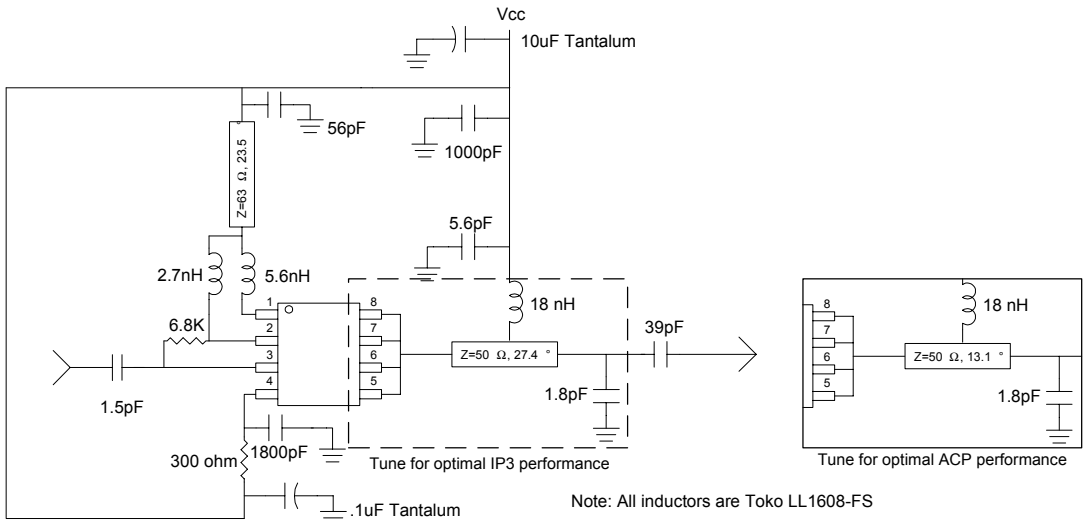

### 2110 - 2170 MHz Evaluation Board Layout

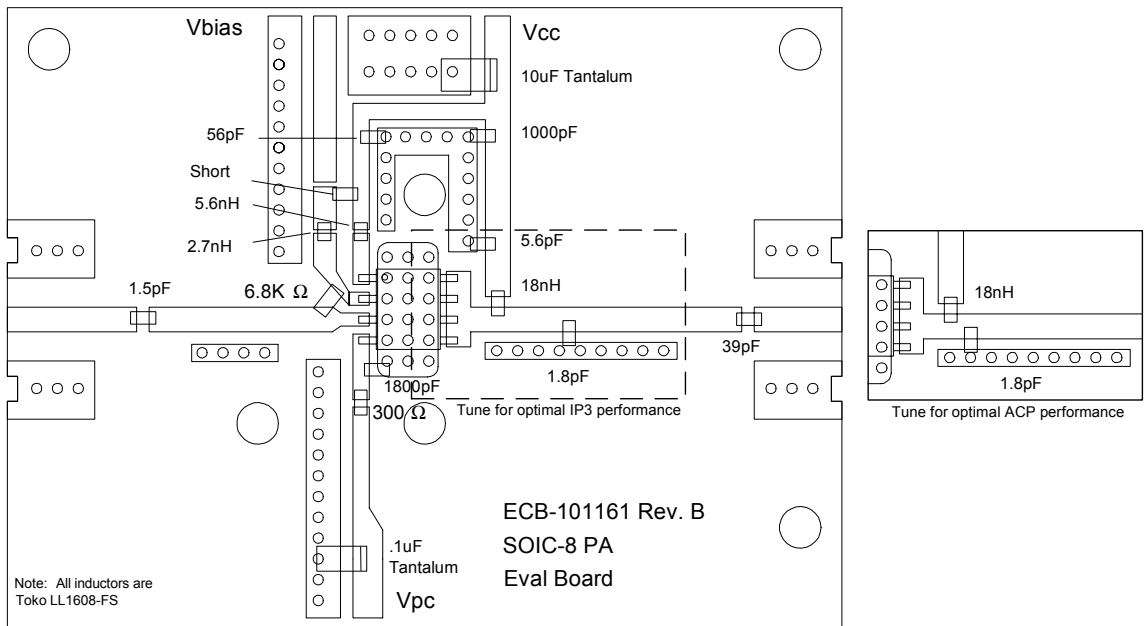

Pin #	Function	Description
1	VC1	VC1 is the supply voltage for the first stage transistor. The configuration as shown on application schematic is required for optimum RF performance.
2	Vbias	Vbias is the bias control pin for the active bias network. Recommended configuration is shown in the Application Schematic.
3	RF In	RF input pin. This pin requires the use of an external DC blocking capacitor as shown in the Application Schematic.
4	VPC2	VPC2 is the bias control pin for the active bias network for the second stage. The recommended configuration is shown in the Application Schematic.
5, 6, 7, 8	RF Out/VC2	RF output and bias pin. Bias should be supplied to this pin through an external RF choke. Because DC biasing is present on this pin, a DC blocking capacitor should be used in most applications (see application schematic). The supply side of the bias network should be well bypassed. An output matching network is necessary for optimum performance.
EPAD	Gnd	Exposed area on the bottom side of the package needs to be soldered to the ground plane of the board for optimum thermal and RF performance. Several vias should be located under the EPAD as shown in the recommended land pattern (page 6).

### Simplified Device Schematic

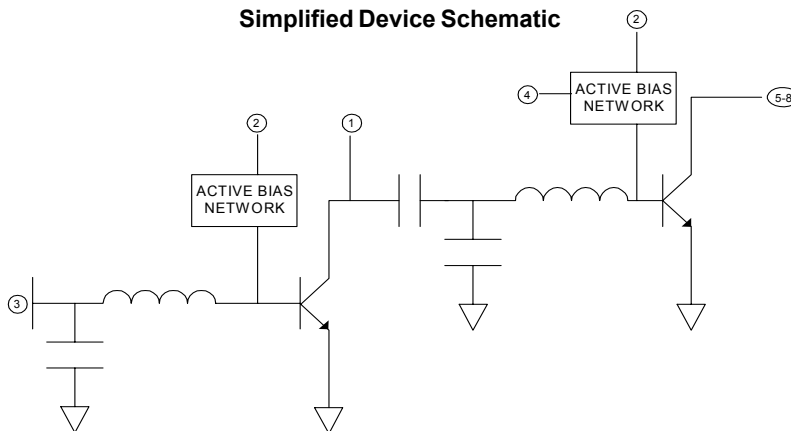

### Absolute Maximum Ratings

Operation of this device above any one of these parameters may cause permanent damage.

Bias Conditions should also satisfy the following expression:  $I_D V_D (\text{max}) < (T_J - T_L) / R_{th,j-l}$

Parameter	Value	Unit
Supply Current ( $V_{c1}$ )	150	mA
Supply Current ( $V_{c2}$ )	750	mA
Device Voltage ( $V_D$ )	6.0	V
Power Dissipation	4.0	W
Operating Lead Temperature ( $T_L$ )	-40 to +85	°C
RF Input Power	+40	mW
Storage Temperature Range	-40 to +150	°C
Operating Junction Temperature ( $T_J$ )	+150	°C



**Caution: ESD sensitive**

Appropriate precautions in handling, packaging and testing devices must be observed.

**Preliminary**  
**SPA-2318 2150 MHz 1 Watt Power Amp**

**Part Number Ordering Information**

Part Number	Devices Per Reel	Reel Size
SPA-2318	500	7"

**Package Outline Drawing**

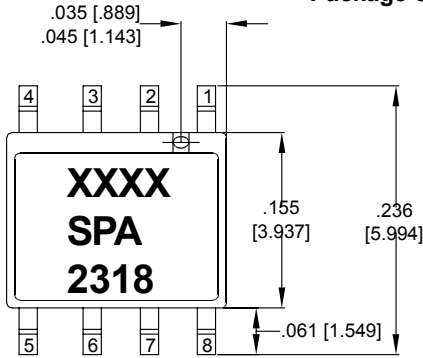

TOP VIEW

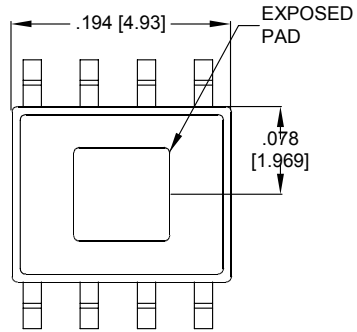

BOTTOM VIEW

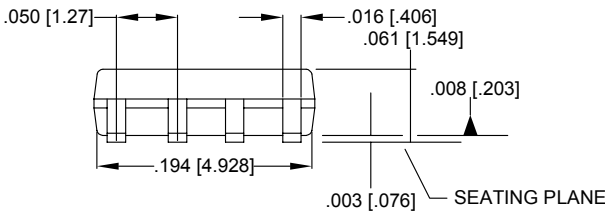

SIDE VIEW

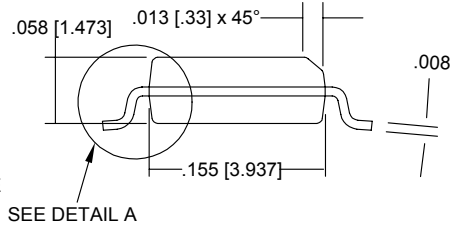

END VIEW

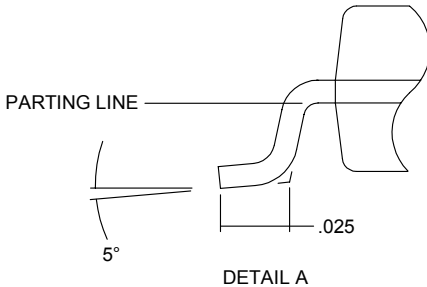

DETAIL A

**Recommended Land Pattern**

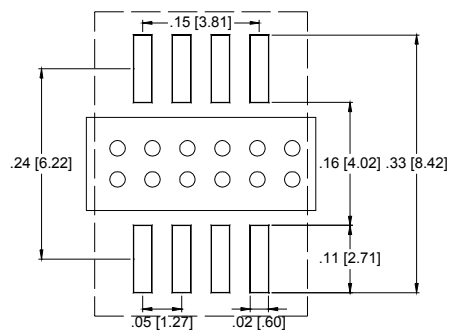

**Note:** XXXX represents the lot code



**Note:** Parts need to be baked prior to use as discussed in application note AN-029 (Special handling information for Exposed Pad™ SOIC-8 products) to ensure no moisture is trapped in the encapsulated package. In production, this baking procedure is not necessary if parts are used within 48 hours of opening the sealed shipping materials.