

## 0.5-11.5 GHz Divide by 4 Static Prescaler

### GaAs Monolithic Microwave IC

*preliminary*

#### Description

The CND2050 is a low power consumption and very high speed divider by 4 manufactured with a 0.6 $\mu$ m GaAs self aligned implanted MESFET process. The design is full differential input/output that allows direct drive into 50 $\Omega$  load.

The CND2050 is available in SOIC8 package form .

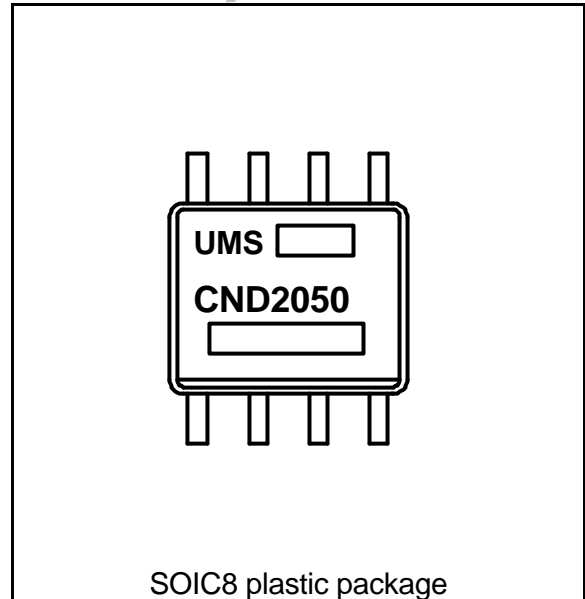

#### Main Features

- Very broad operating frequency range
- Low power dissipation: 250mW
- Single supply operation: +5V or -5V
- High input sensitivity:  
-10dBm@10 GHz at 25°C
- Low phase noise: -139dBc/Hz at 1KHz

#### Main Characteristics

at Tamb= +25°C

Symbol	Parameter	Min	Typ	Max	Unit
Vdd	Bias supply (with Vss = 0)	3.3	5	6	V
Vss	Bias supply (with Vdd = 0)	-6	-5	-3.3	V
Pdiss	Power dissipation	90	250	350	mW
Fmin	Minimum input frequency			0.5	GHz
Fmax	Maximum input frequency (Vdd=5V)	10	12		GHz

ESD Protections: Electrostatic discharge sensitive device. Observe handling precautions!

**Electrical Characteristics (1)**

Guaranteed electrical specifications at +25°C  
 Tested under configuration described in Fig.1 and Fig.2  
 Vdd = 5V , Vss = 0 ; Pin = 0 dBm ; Zo = 50 Ω

Symbol	Parameter	Min	Typ	Max	Unit
Fmin	Minimum input frequency (Differential or single input)			0.5	GHz
Fmax	Maximum input frequency differential input	10	12		GHz
	single input	9	11		GHz
Pout	Minimum output power (Differential or single input)	-5	-2		dBm

Guaranteed electrical specifications at +25°C  
 Tested under configuration described in Fig.1  
 Differential inputs ; Vss = 0 ; Pin = 0 dBm ; Zo = 50 Ω

Symbol	Parameter	Min	Typ	Max	Unit
Fmin	Minimum input frequency Vdd = 3.3 to 5 V			0.5	GHz
Fmax	Maximum input frequency Vdd = 5V	10	12		GHz
	Vdd = 3.3V	9	11		GHz
Pout	Minimum output power Vdd = 5V	-5	-2		dBm
	Vdd = 3.3V	-10	-7		dBm

**Electrical Characteristics (2)**

Guaranteed electrical specifications over the temperature range of -40°C to +85°C

Tested under configuration described in Fig.1

Differential inputs ; Vss = 0 ; Pin = 0 dBm ; Zo = 50 Ω

Symbol	Parameter	Min	Typ	Max	Unit
Fmin	Minimum input frequency Vdd = 3.3 to 5 V			0.5	GHz
Fmax	Maximum input frequency Vdd = 5V	9	11		GHz
	Vdd = 3.3V	8	10		GHz
Pout	Minimum output power Vdd = 5V	-6	-3		dBm
	Vdd = 3.3V	-11	-8		dBm

Guaranteed electrical specifications over the temperature range of -40°C to +85°C

Single or differential inputs ; Vss = 0 ; Zo = 50 Ω

Symbol	Parameter	Min	Typ	Max	Unit
Pin max	Maximum operational input power Vdd = 3.3 to 5 V			10	dBm
Idd	Supply current Vdd= 5V	35	45	70	mA
	Vdd=3.3V	20	25	40	mA
Hr	Harmonic rejection (ouput signal)	10			dBc

## Absolute Maximum Ratings (1)

Tamb= 25°C

Symbol	Parameter	Values	Units
Vdd	Drain voltage	7	V
Pin	Maximum input power (2)	15	dBm
Top	Operating temperature range	-40 to +85	°C
Tstg	Storage temperature range	-65 to +175	°C

- (1) Operation of this device above anyone of these parameters may cause permanent damage
- (2) Duration <1s.

## Typical Characteristics (1)

Typical input power versus frequency

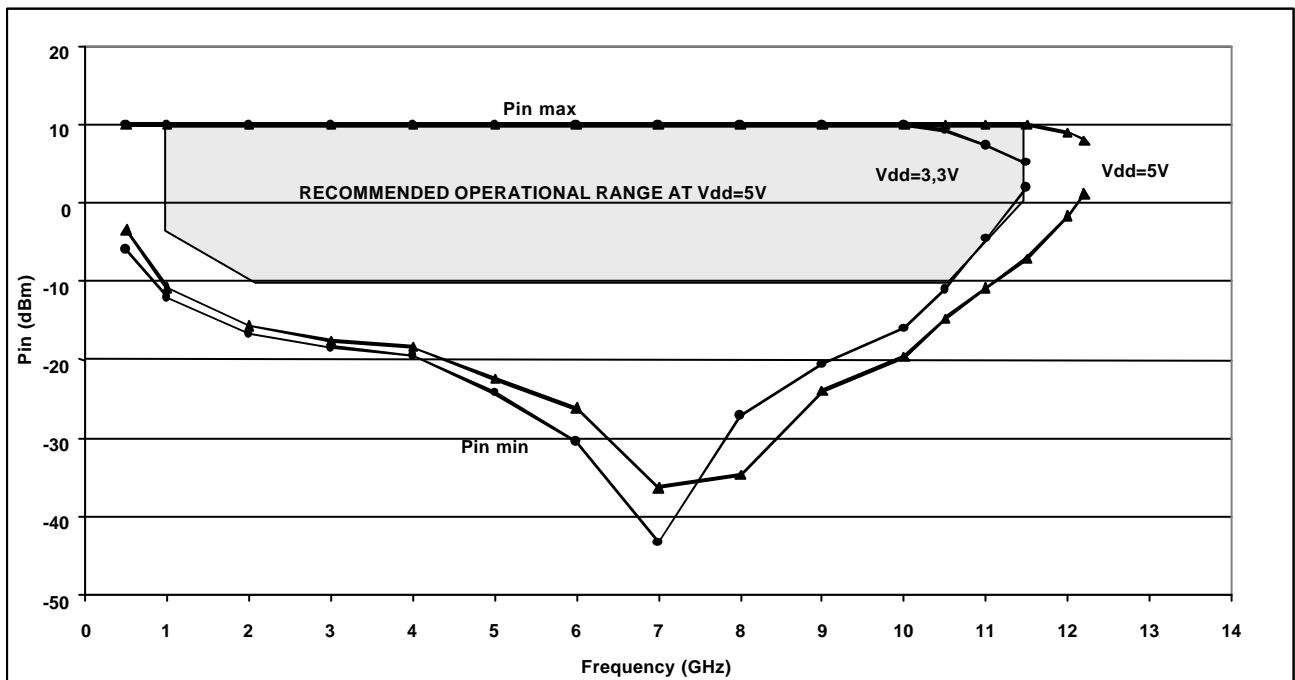

Tamb= 25°C, Zo=50Ω, Vdd=5V or 3.3V ; Vss = 0 ; differential inputs

Typical Characteristics (2)

Typical input power versus frequency

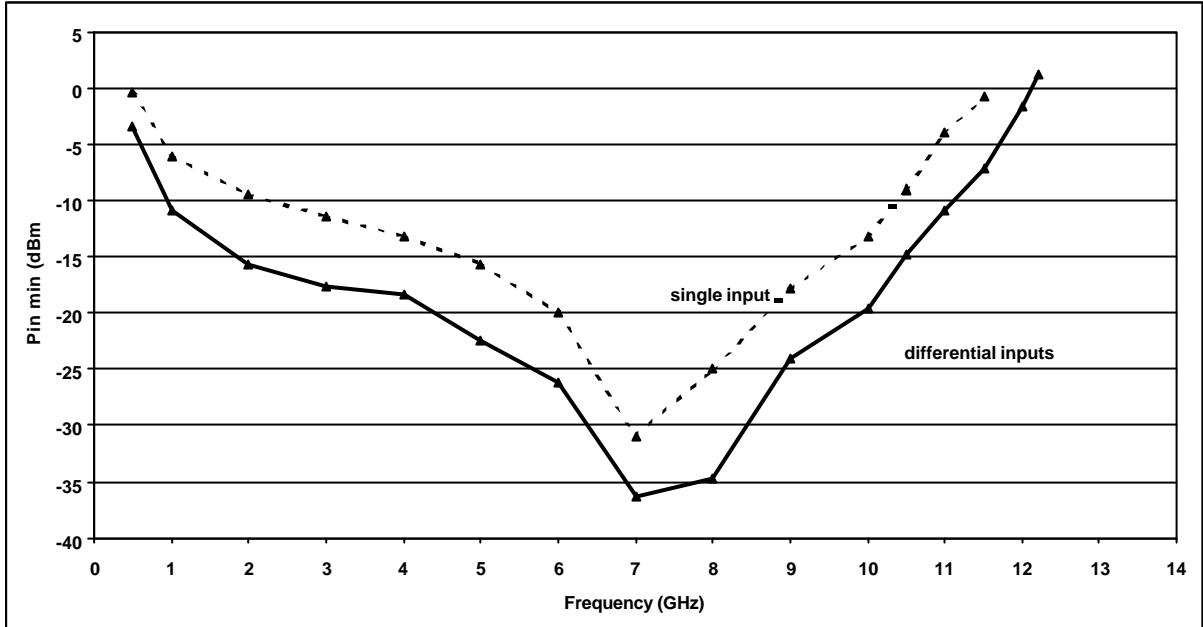

Tamb= 25°C, Zo=50Ω, Vdd=5V ; Vss = 0 ; differential inputs or single input

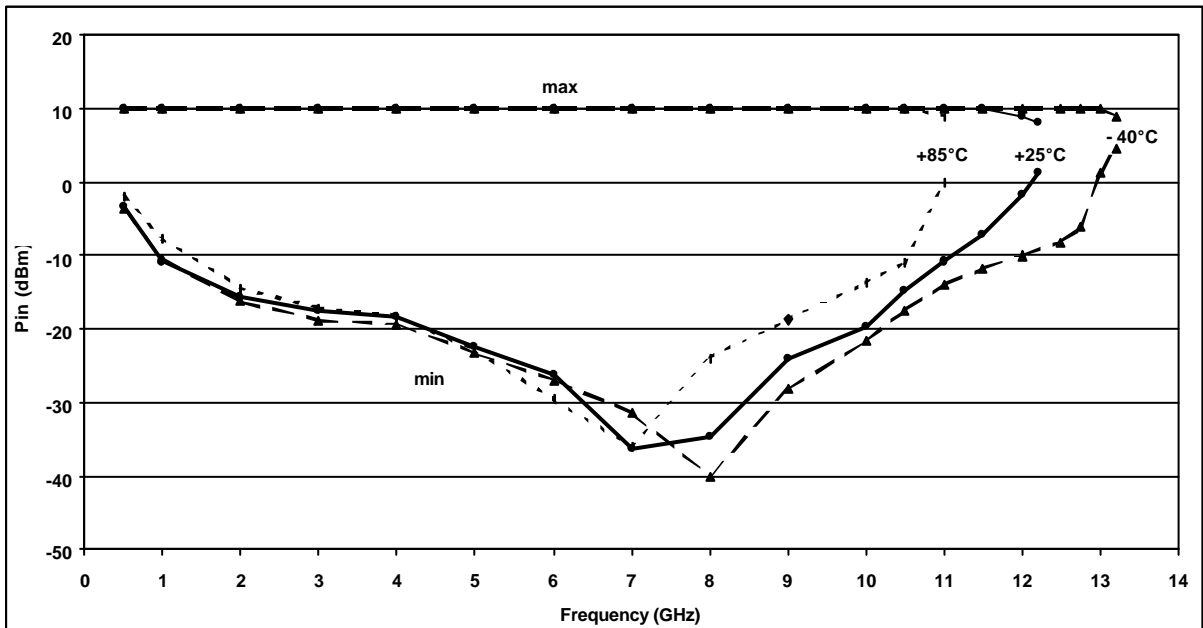

Tamb= -40 to +85°C, Zo=50Ω, Vdd=5V ; Vss = 0 ; differential inputs

**Typical Characteristics (3)**

**Output power versus frequency**

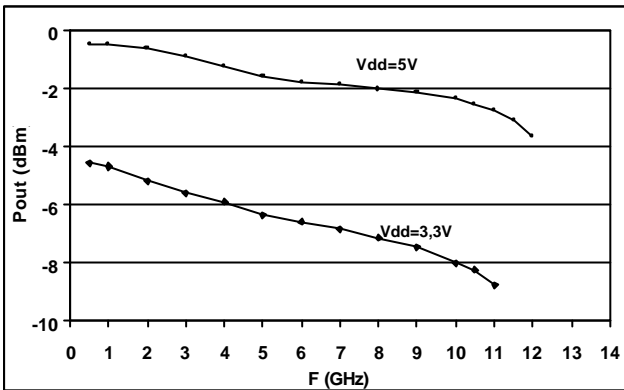

**Bias current versus Vdd**

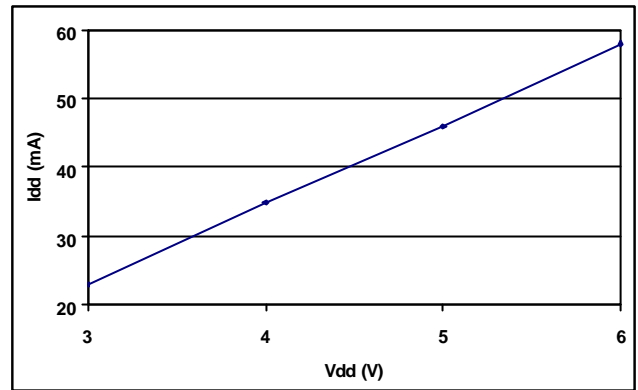

Tamb= 25°C, Zo=50Ω, Vdd=5V or 3.3V ; Vss = 0 ; differential inputs or single input

**SSB Phase noise versus Offset Frequency (Fin=4GHz)**

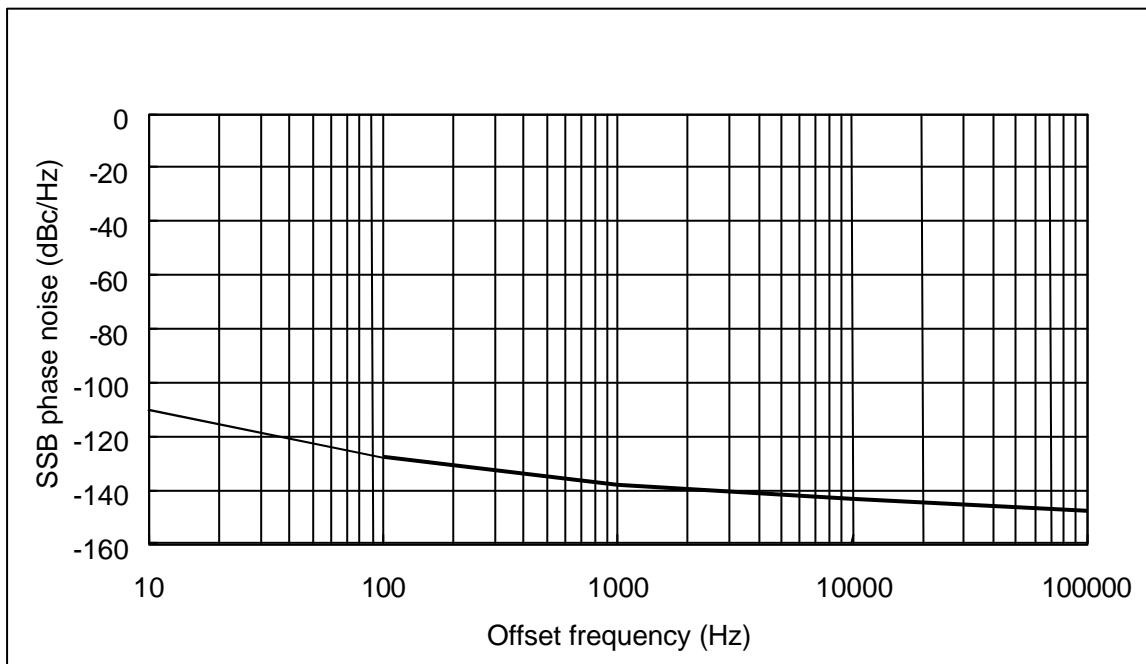

Typical bias tuning

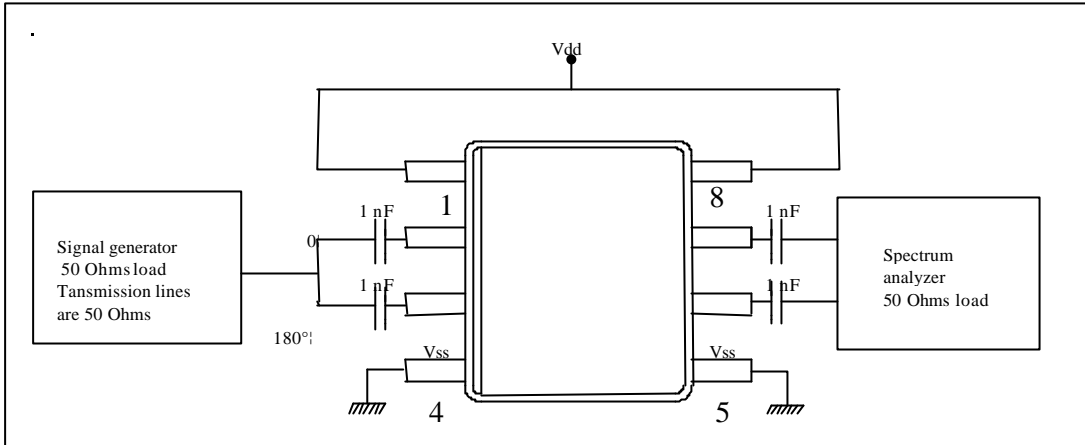

Fig.1 : Typical measurement and RF biasing configuration with differential inputs

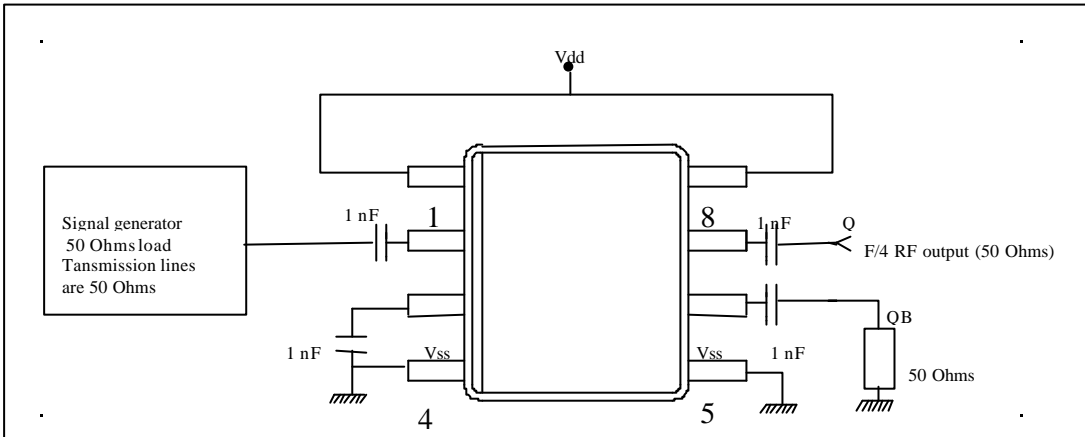

Fig.2 : RF biasing configuration with single input and output

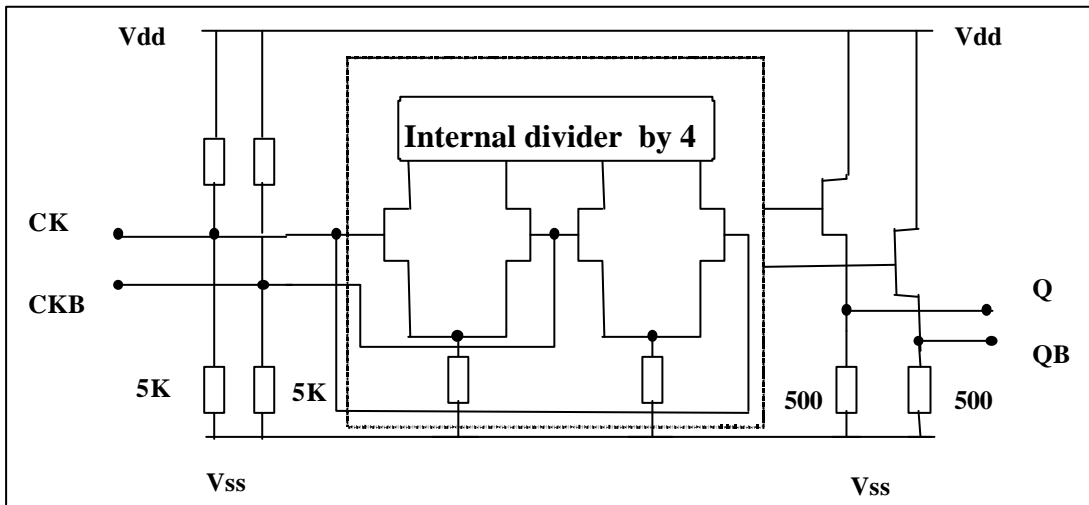
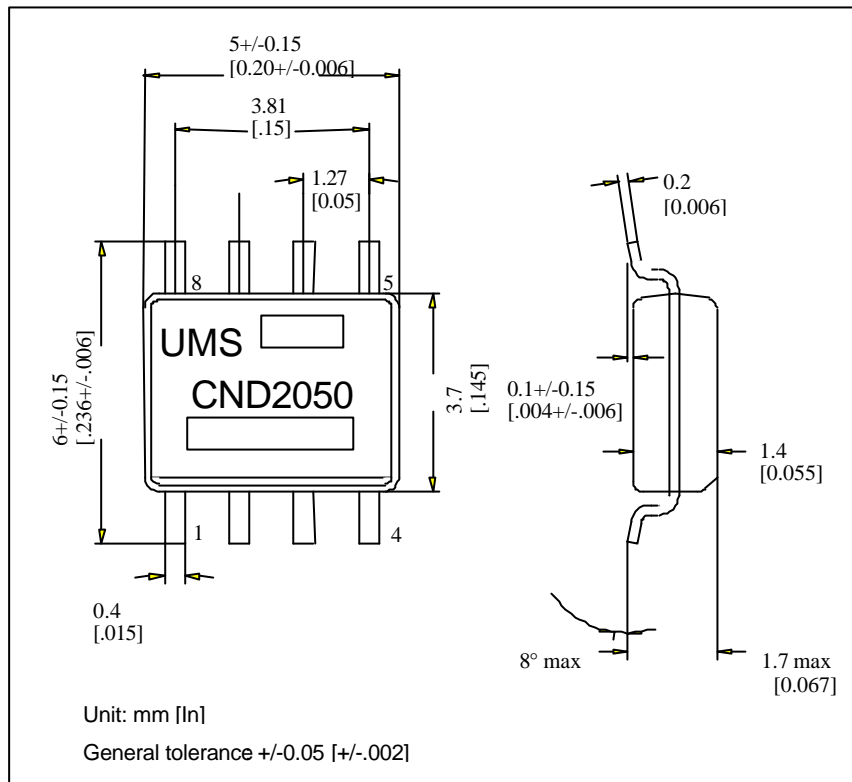

Fig.3 : Chip block diagram

## SOIC8 Mechanical Data



Pin out	Signal
1	Vdd
2	CK
3	CKB
4	Vss
5	Vss
6	QB
7	Q
8	Vdd

## Ordering Information

SOIC8 Package : CND2050-DAF/20

Information furnished is believed to be accurate and reliable. However **United Monolithic Semiconductors S.A.S.** assumes no responsibility for the consequences of use of such information nor for any infringement of patents or other rights of third parties which may result from its use. No license is granted by implication or otherwise under any patent or patent rights of **United Monolithic Semiconductors S.A.S.** Specifications mentioned in this publication are subject to change without notice. This publication supersedes and replaces all information previously supplied. **United Monolithic Semiconductors S.A.S.** products are not authorised for use as critical components in life support devices or systems without express written approval from **United**



Monolithic Semiconductors S.A.S.