

SHINDENGEN

Schottky Rectifiers (SBD)

Dual

DE5SC4M

40V 5A

FEATURES

- SMT
- Tj150
- P_{RRSM} avalanche guaranteed
- High current capacity with Small Package

APPLICATION

- Switching power supply
- DC/DC converter
- Home Appliances, Office Equipment
- Telecommunication

OUTLINE DIMENSIONS

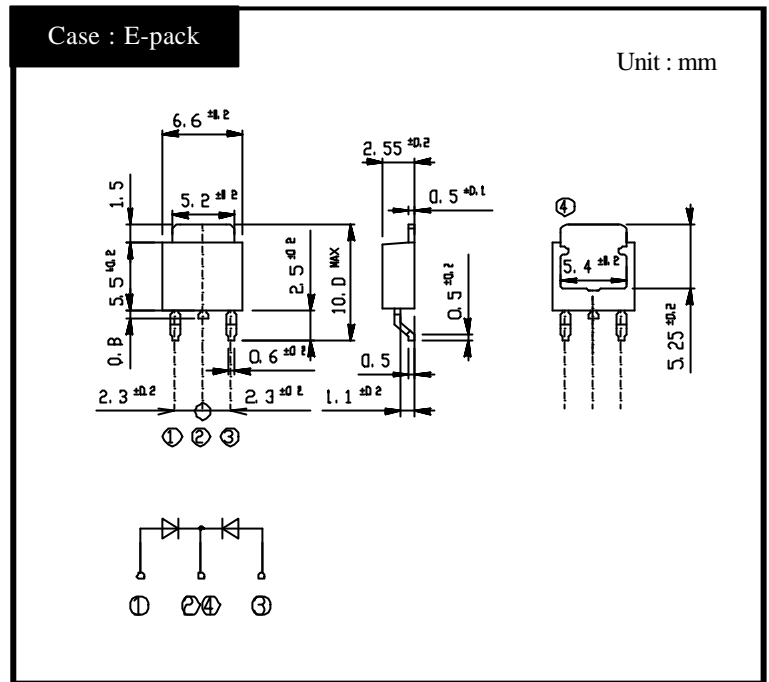

RATINGS

Absolute Maximum Ratings (If not specified Tc=25)

Item	Symbol	Conditions	Ratings	Unit
Storage Temperature	T _{stg}		-40 ~ 150	
Operating Junction Temperature	T _j		150	
Maximum Reverse Voltage	V _{RM}		40	V
Repetitive Peak Surge Reverse Voltage	V _{RRSM}	Pulse width 0.5ms, duty 1/40	45	V
Average Rectified Forward Current	I _o	50Hz sine wave, R-load, Rating for each diode I _o /2, Ta=25, On alumina substrate	3	A
		50Hz sine wave, R-load, Rating for each diode I _o /2, Tc=101	5	
Peak Surge Forward Current	I _{FSM}	50Hz sine wave, Non-repetitive 1 cycle peak value, Tj=125	80	A
Repetitive Peak Surge Reverse Power	P _{RRSM}	Pulse width 10 μs, Rating of per diode, Tj=25	330	W

Electrical Characteristics (If not specified Tc=25)

Item	Symbol	Conditions	Ratings	Unit
Forward Voltage	V _F	I _F =2.5A, Pulse measurement, Rating of per diode	Max.0.55	V
Reverse Current	I _R	V _R =V _{RM} , Pulse measurement, Rating of per diode	Max.3.5	mA
Junction Capacitance	C _j	f=1MHz, V _R =10V, Rating of per diode	Typ.150	pF
Thermal Resistance	j-c	junction to case	Max.12	/W
	ja	junction to ambient, On alumina substrate	Max.55	

DE5SC4M Forward Voltage

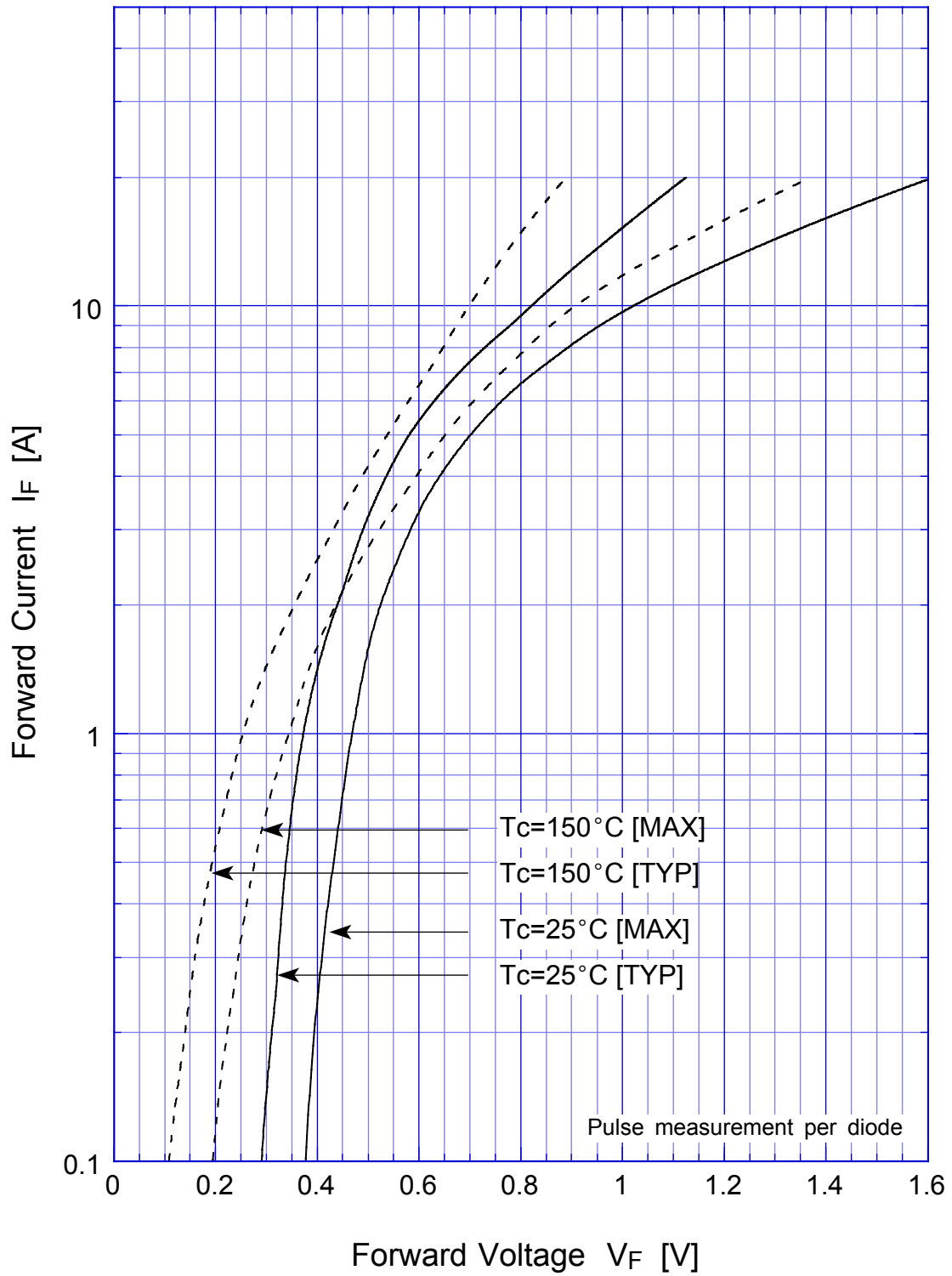

DE5SC4M Junction Capacitance

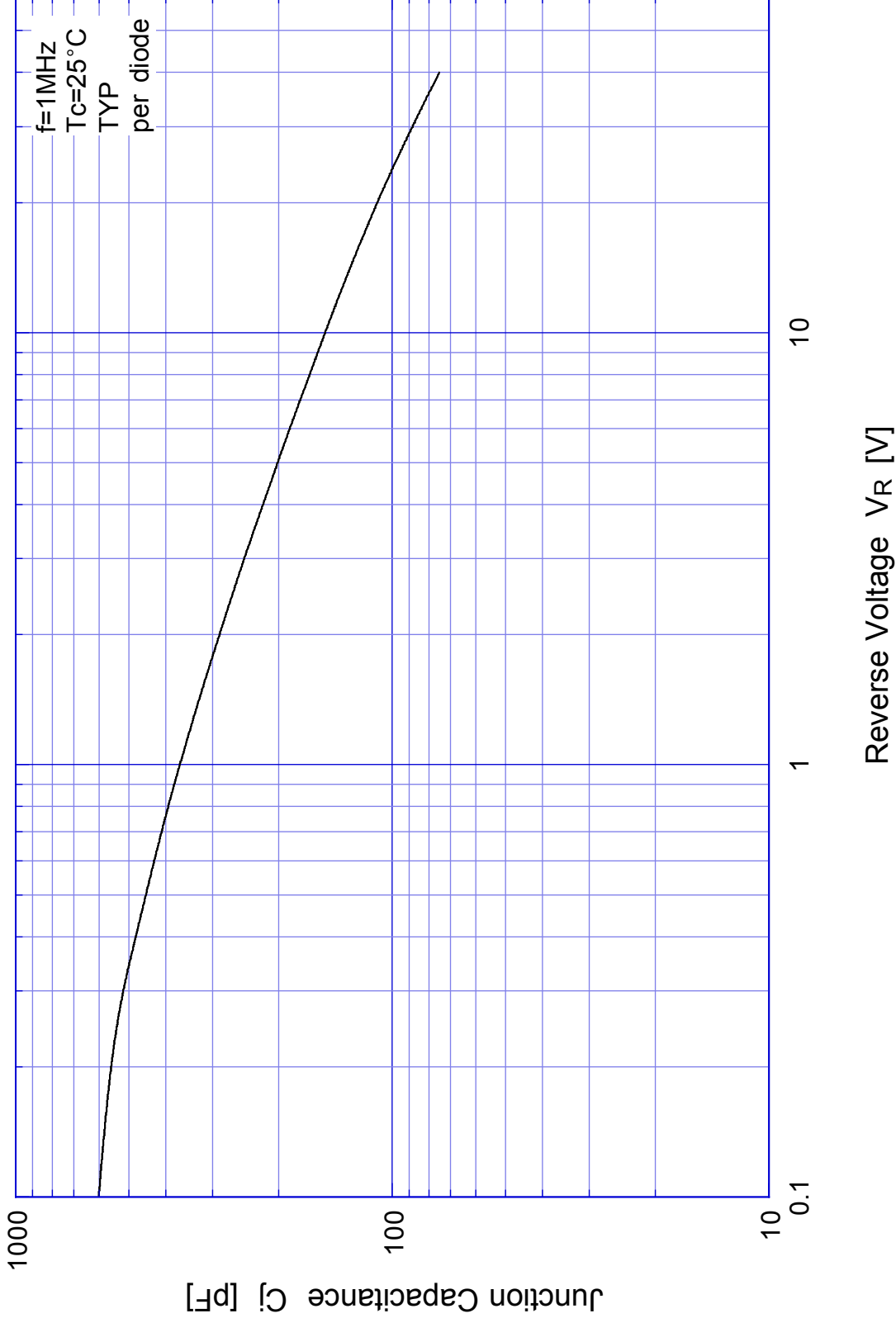

DE5SC4M Reverse Current

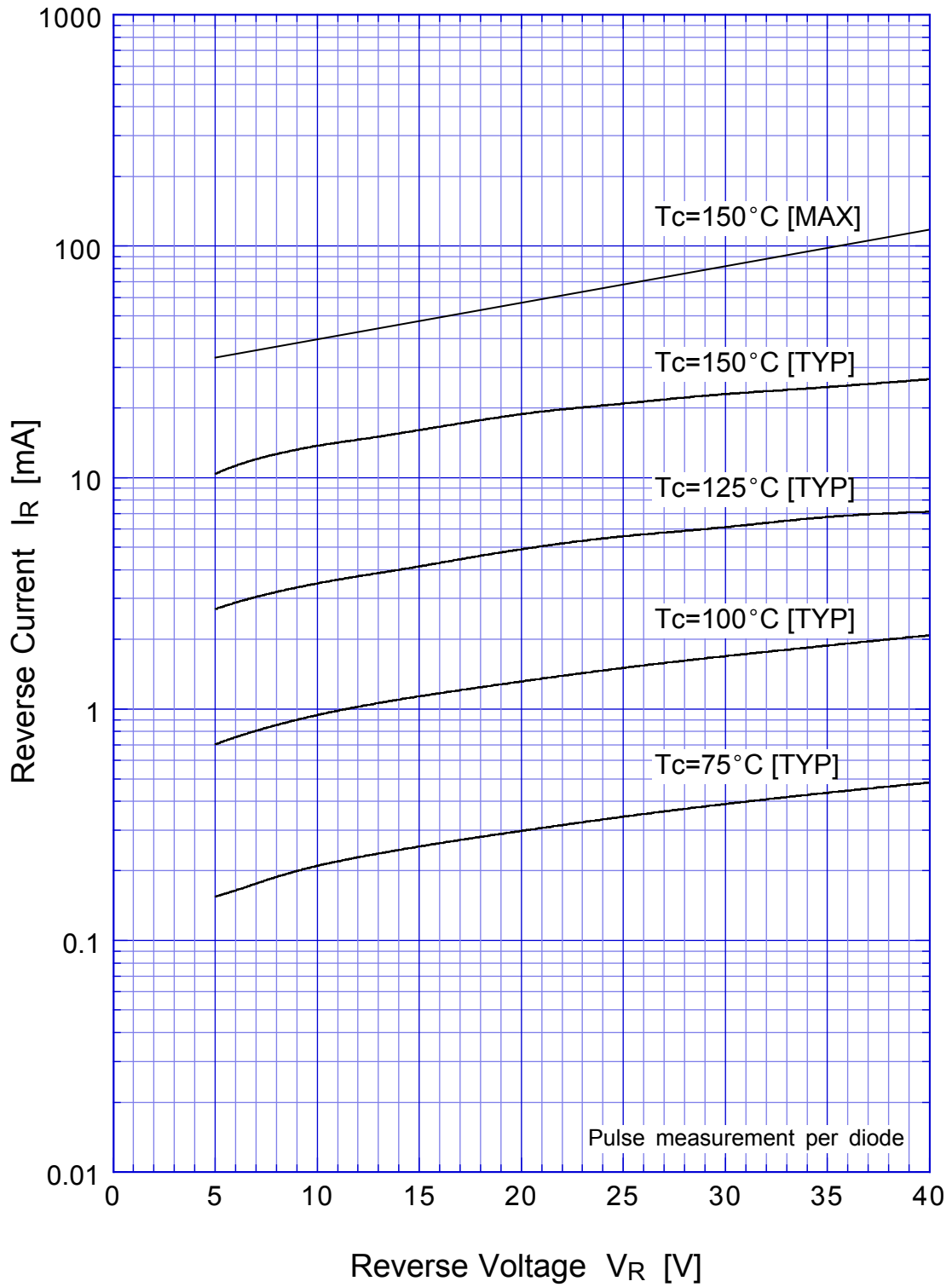

DE5SC4M Reverse Power Dissipation

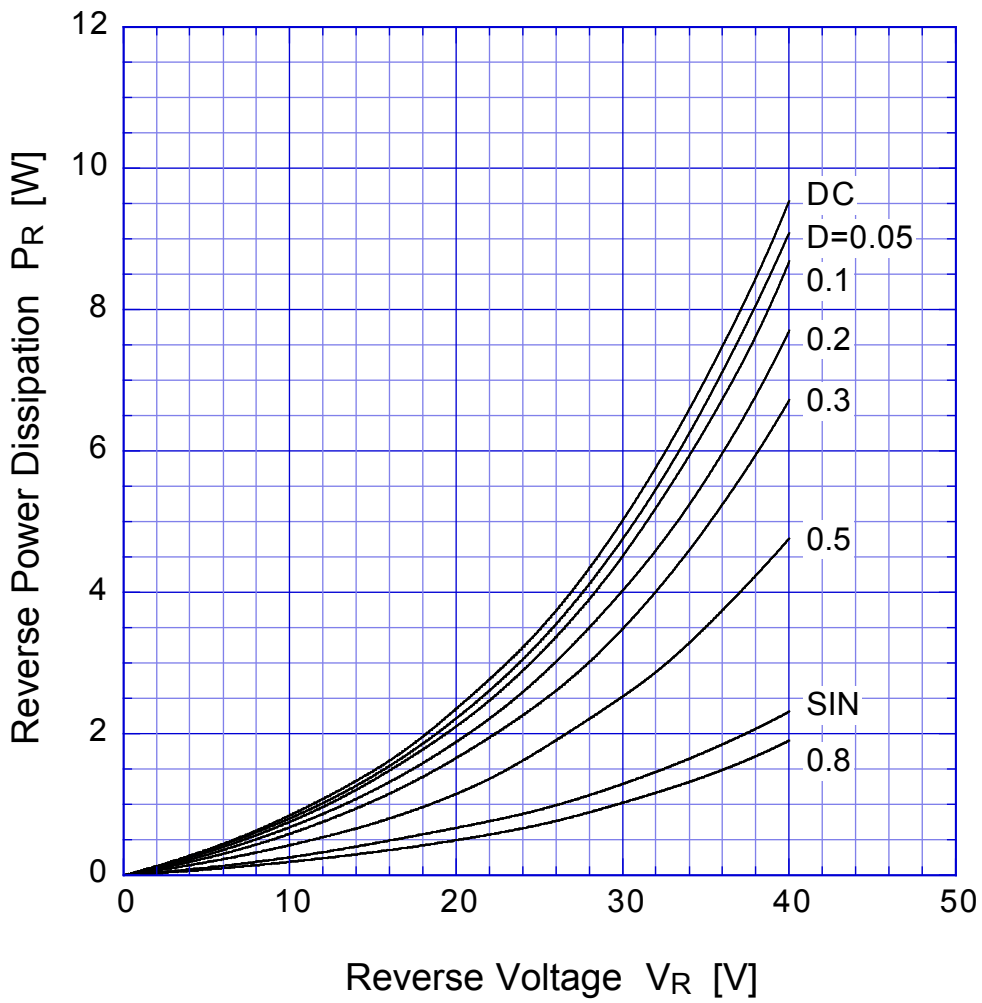

$T_j = 150^\circ\text{C}$

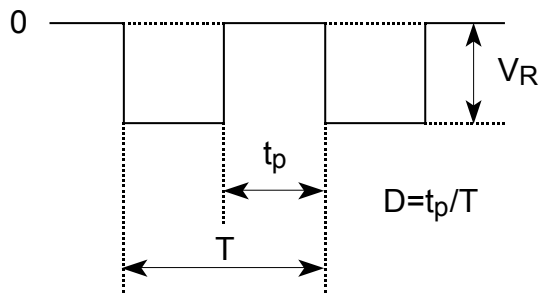

DE5SC4M Forward Power Dissipation

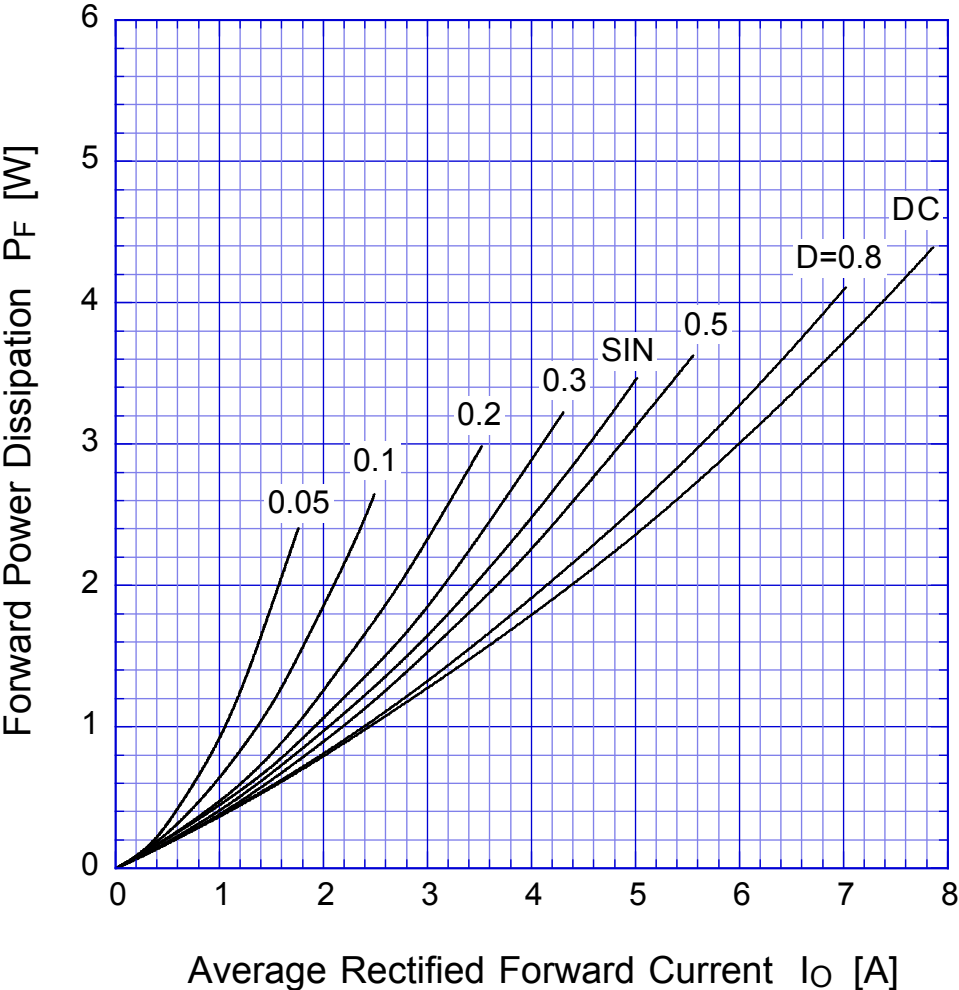

$T_j = 150^\circ\text{C}$

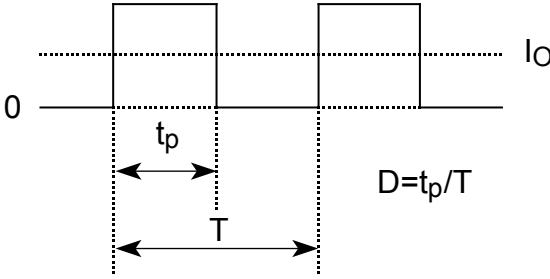

DE5SC4M

Derating Curve

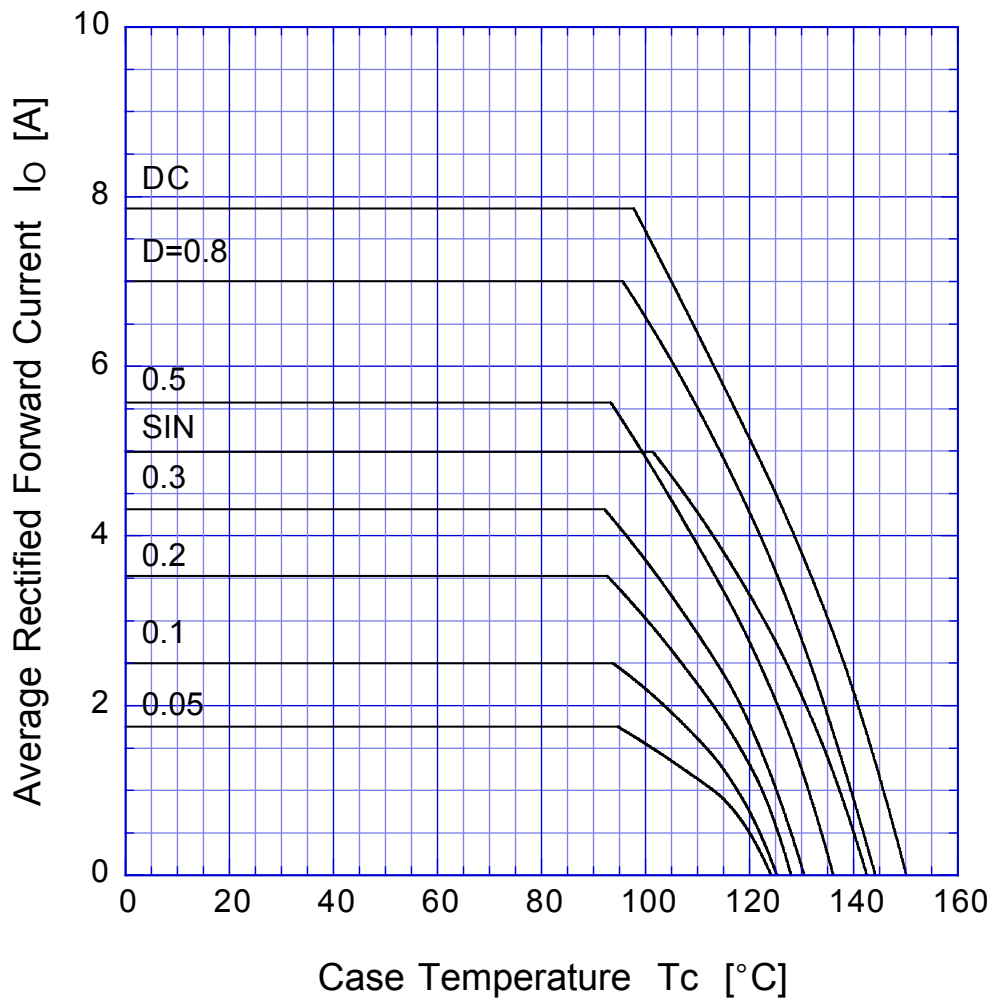

$V_R = 20V$



DE5SC4M

Derating Curve

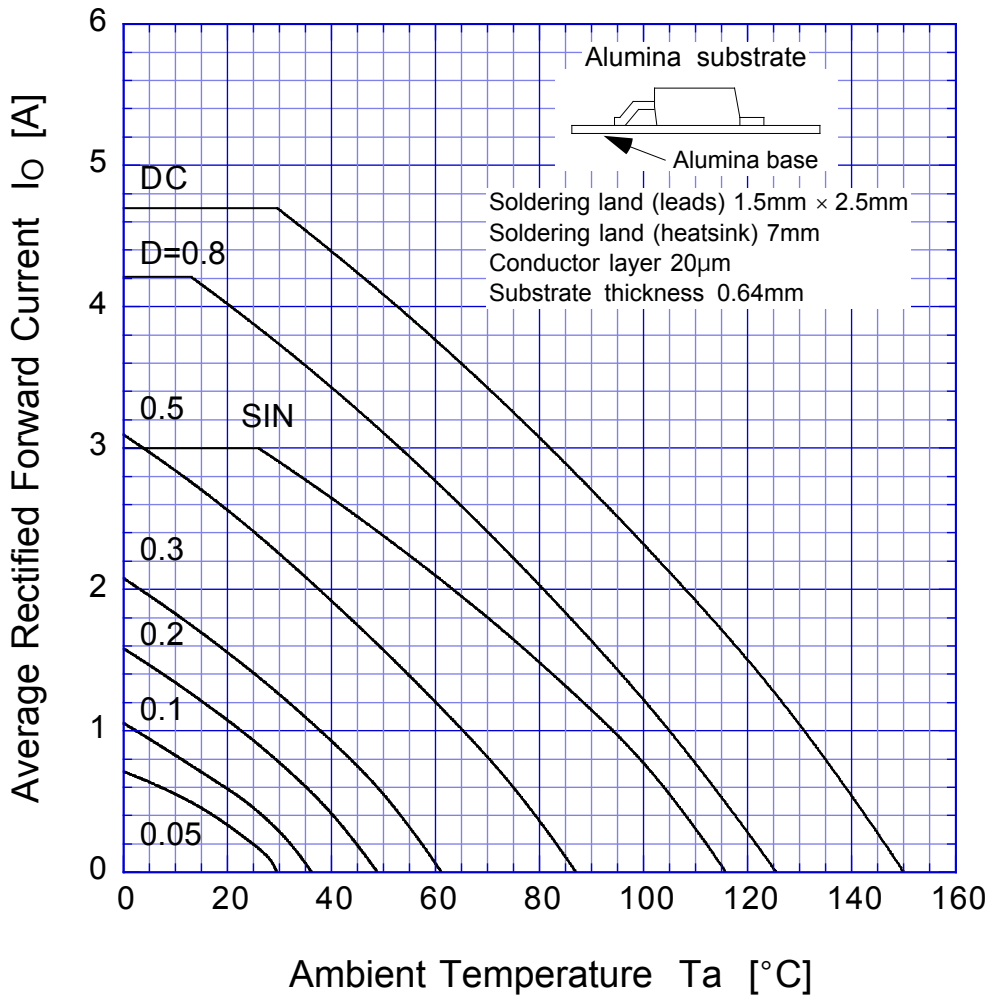

$V_R = 20V$

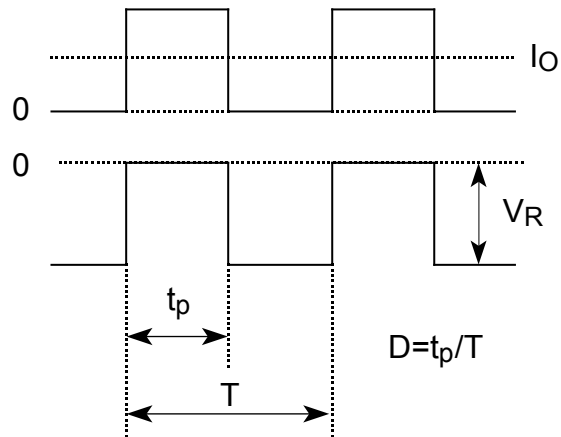

DE5SC4M Peak Surge Forward Capability

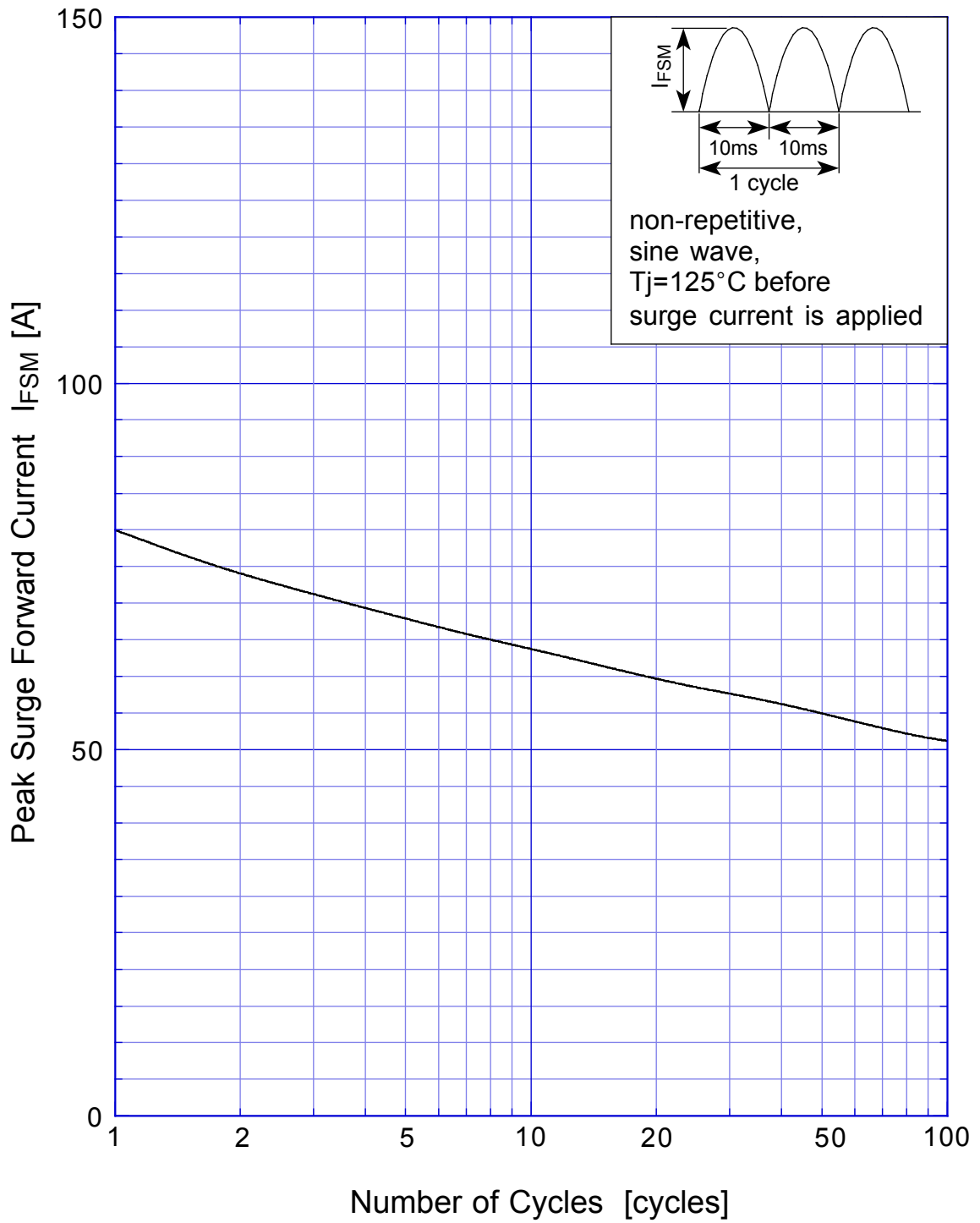

SBD Repetitive Surge Reverse Power Derating Curve

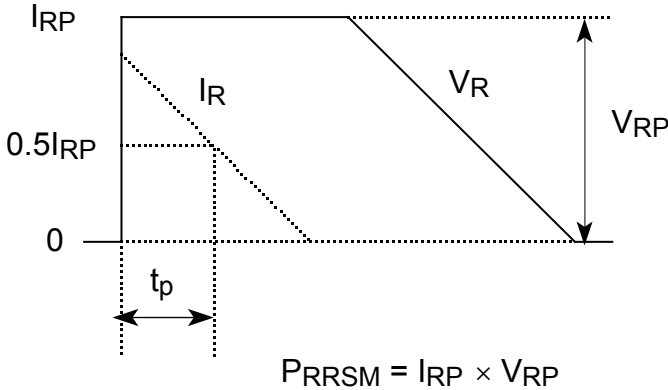
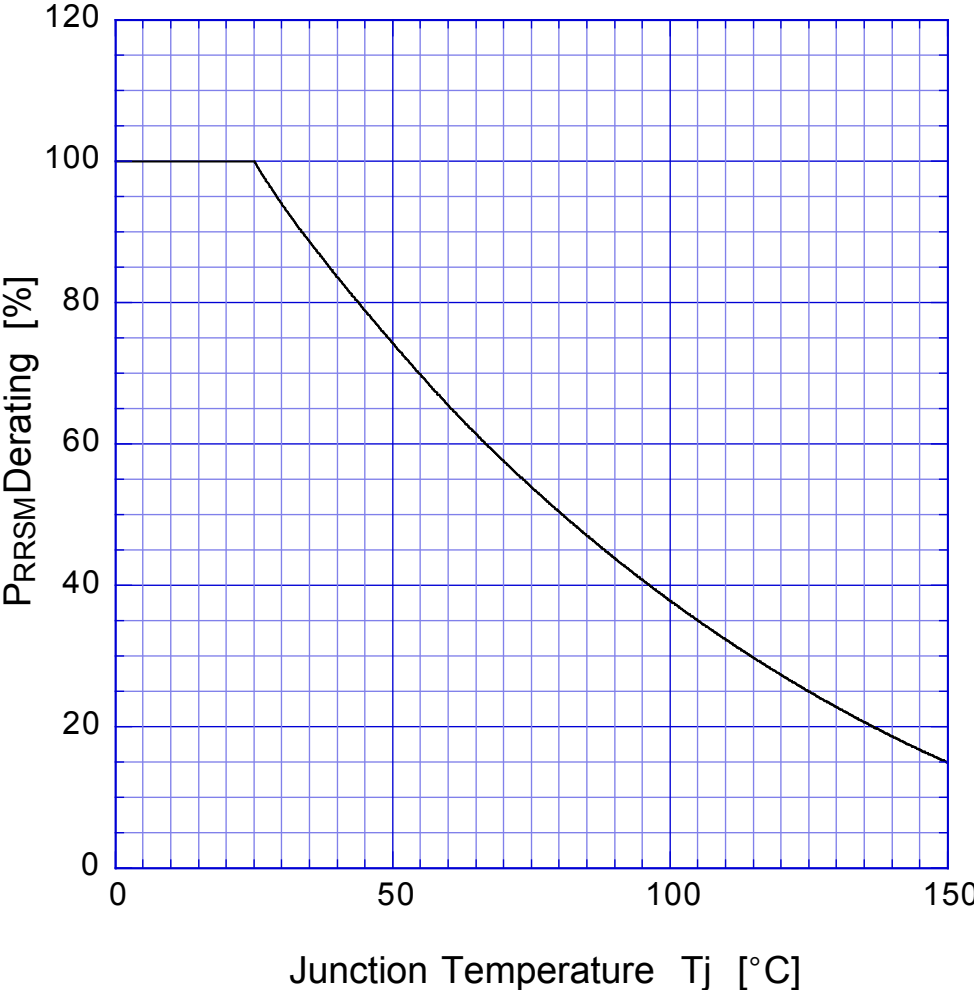

SBD

Repetitive Surge Reverse Power Capability

