

SiGe HBT DUAL CHANNEL GAIN BLOCK MMIC AMPLIFIER, DC - 5.0 GHz

Typical Applications

The HMC471MS8G is a dual RF/IF gain block & LO or PA driver:

- Cellular / PCS / 3G
- Fixed Wireless & WLAN
- CATV, Cable Modem & DBS
- Microwave Radio & Test Equipment

Functional Diagram

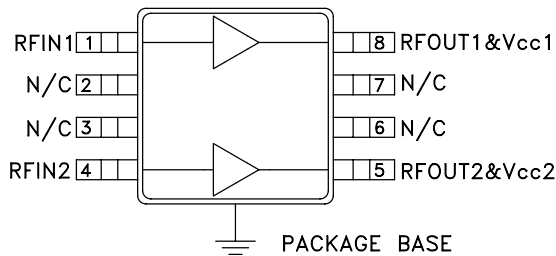

Features

- +20 dBm P1dB Output Power
- 20 dB Gain
- Output IP3: +34 dBm
- Supply (Vs): +6V to +12V
- 14.9 mm² Ultra Small 8 Lead MSOP

General Description

The HMC471MS8G is a SiGe HBT Dual Channel Gain Block MMIC SMT amplifier covering DC to 5 GHz. This versatile product contains two gain blocks, packaged in a single 8 lead plastic MSOP, for use as either separate cascadable 50 Ohm RF/IF gain stages, LO or PA drivers or with both amplifiers combined utilizing external 90° hybrids to create a high linearity driver amplifier. Each amplifier in the HMC471MS8G offers 20 dB of gain, +20dBm P1dB with a +34 dBm output IP3 at 850 MHz while requiring only 80 mA from a single positive supply. The combined dual amplifier circuit delivers up to +21 dBm P1dB with +36dBm OIP3 for specific application bands through 4 GHz.

Electrical Specifications, Vs= 8.0 V, Rbias= 39 Ohm, TA = +25° C

Parameter		Min.	Typ.	Max.	Units
Gain	DC - 1.0 GHz	18.5	21		dB
	1.0 - 2.0 GHz	15.5	17.5		dB
	2.0 - 3.0 GHz	13	15		dB
	3.0 - 4.0 GHz	10.5	12.5		dB
	4.0 - 5.0 GHz	8	10		dB
Gain Variation Over Temperature	DC - 5.0 GHz		0.008	0.012	dB/ °C
Input Return Loss	DC - 2.0 GHz		12		dB
	2.0 - 4.0 GHz		14		dB
	4.0 - 5.0 GHz		8		dB
Output Return Loss	DC - 1.0 GHz		13		dB
	1.0 - 2.0 GHz		9		dB
	2.0 - 4.0 GHz		7		dB
	4.0 - 5.0 GHz		5		dB
Reverse Isolation	DC - 5.0 GHz		20		dB
Output Power for 1 dB Compression (P1dB)	0.5 - 1.0 GHz	16	19		dBm
	1.0 - 2.0 GHz	14	17		dBm
	2.0 - 3.0 GHz	11	14		dBm
	3.0 - 4.0 GHz	9	12		dBm
	4.0 - 5.0 GHz	7	10		dBm
Output Third Order Intercept (IP3) (Pout= 0 dBm per tone, 1 MHz spacing)	0.5 - 1.0 GHz		34		dBm
	1.0 - 2.0 GHz		32		dBm
	2.0 - 3.0 GHz		27		dBm
	3.0 - 4.0 GHz		25		dBm
Noise Figure	DC - 4.0 GHz		3.25		dB
	4.0 - 5.0 GHz		4.0		dB
Supply Current (Icq)			80		mA

Note: Data taken with broadband bias tee on device output. All specifications refer to a single amplifier.

For price, delivery, and to place orders, please contact Hittite Microwave Corporation:
12 Elizabeth Drive, Chelmsford, MA 01824 Phone: 978-250-3343 Fax: 978-250-3373
Order Online at www.hittite.com

SiGe HBT DUAL CHANNEL GAIN BLOCK MMIC AMPLIFIER, DC - 5.0 GHz

Broadband Gain & Return Loss

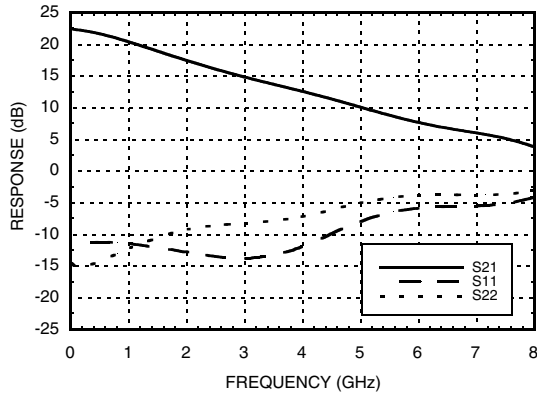

Gain vs. Temperature

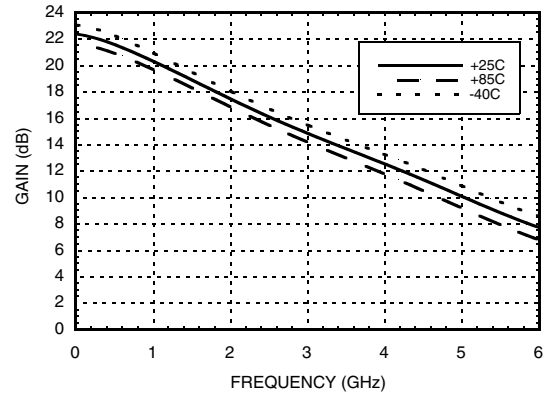

Input Return Loss vs. Temperature

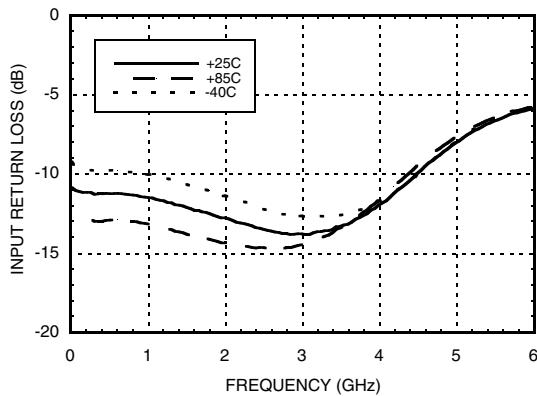

Output Return Loss vs. Temperature

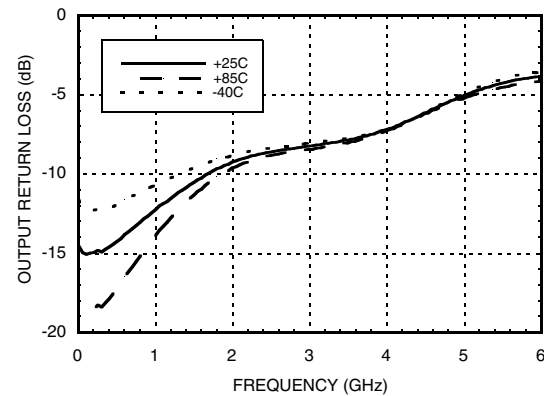

Reverse Isolation vs. Temperature

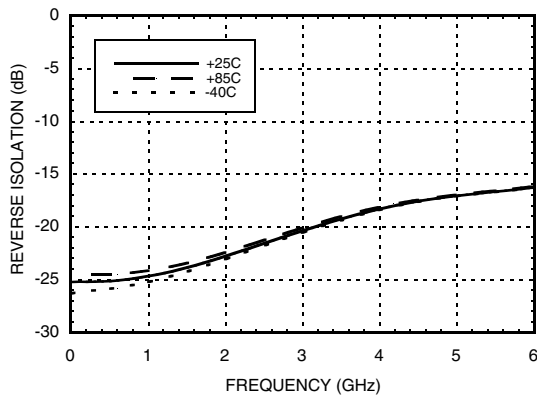

Noise Figure vs. Temperature

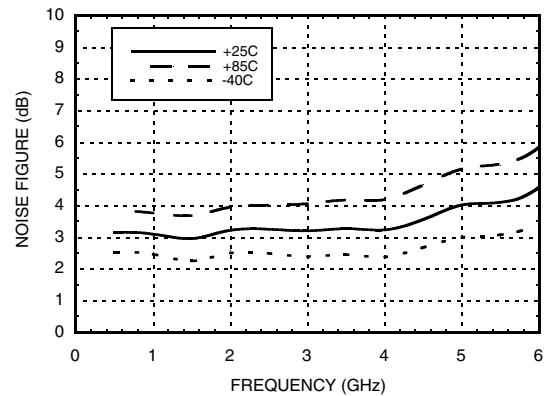

Data shown is of a single amplifier.

SiGe HBT DUAL CHANNEL GAIN BLOCK MMIC AMPLIFIER, DC - 5.0 GHz

P1dB vs. Temperature

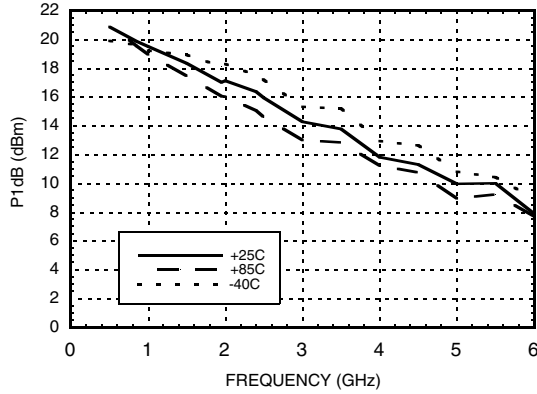

Psat vs. Temperature

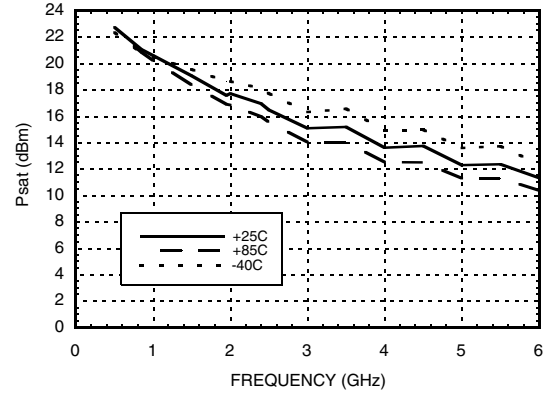

Output IP3 vs. Temperature

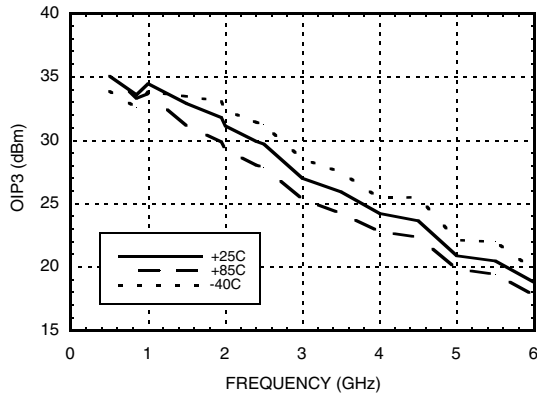

Gain, Power & OIP3 vs. Supply Voltage for Constant Icc= 80 mA @ 850 MHz

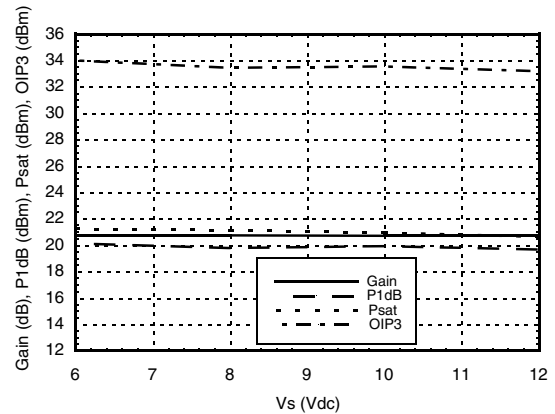

Vcc vs. Icc Over Temperature for Fixed Vs= 8V, RBIAS= 51 Ohms

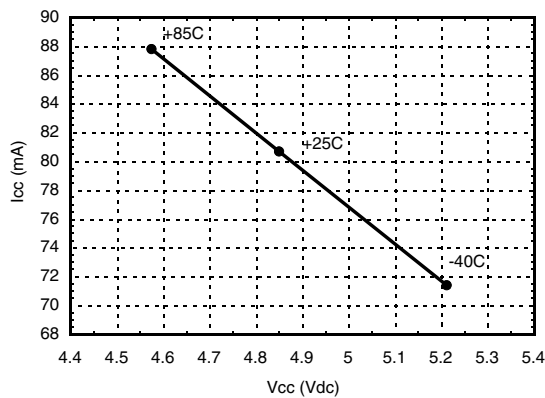

Cross Channel Isolation

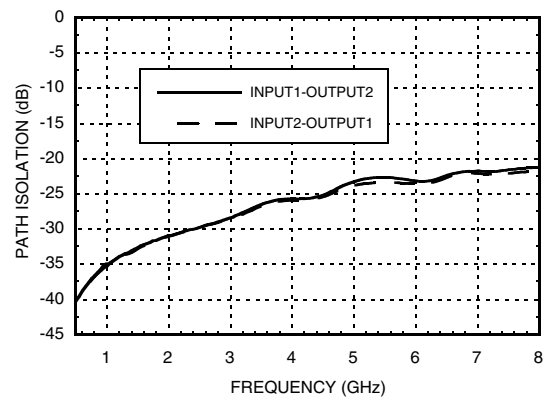

Data shown is of a single amplifier.

SiGe HBT DUAL CHANNEL GAIN BLOCK MMIC AMPLIFIER, DC - 5.0 GHz

Gain*

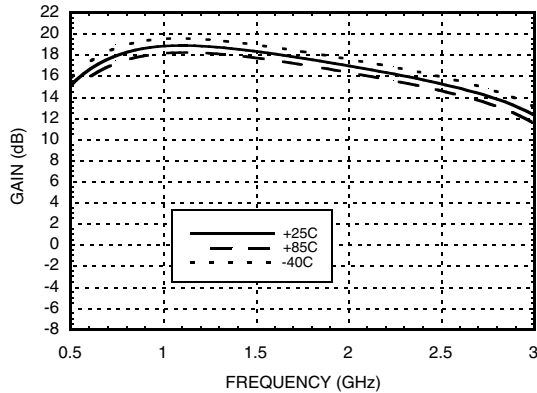

Input & Output Return Loss *

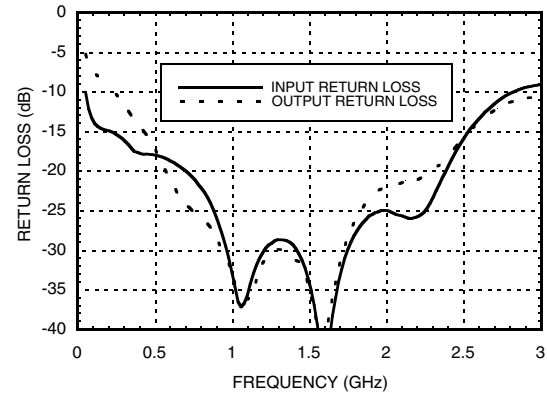

Reverse Isolation*

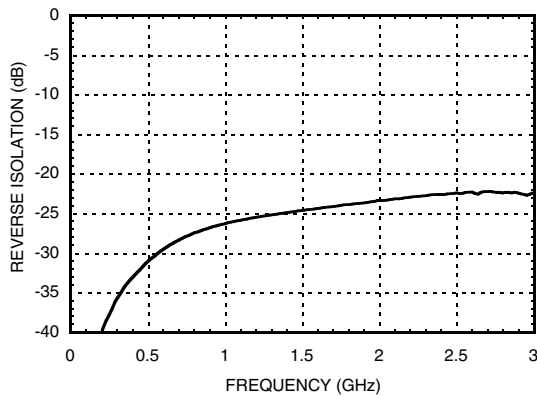

Output IP3*

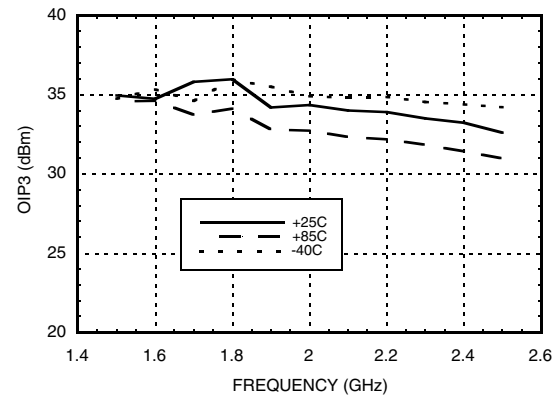

Output P1dB*

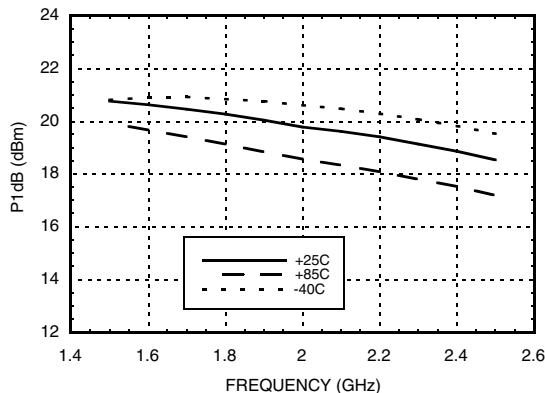

Output Psat*

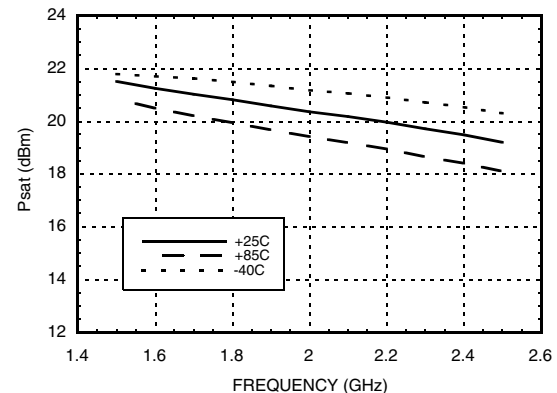

* Measurements shown are of both channels with 1.5 - 2.5 GHz 90° splitter/combiners on input & output (see application circuit for balanced operation).

SiGe HBT DUAL CHANNEL GAIN BLOCK MMIC AMPLIFIER, DC - 5.0 GHz

Absolute Maximum Ratings

Collector Bias Voltage (Vcc)	+6.0 Vdc
Collector Bias Current (Icc)	100 mA
RF Input Power (RFIn)(Vcc = +4.2 Vdc)	+17 dBm
Junction Temperature	150 °C
Continuous Pdiss (T = 85 °C) (derate 32.6 mW/°C above 85 °C)	2.12 W
Thermal Resistance (junction to ground paddle)	30.7 °C/W
Storage Temperature	-65 to +150 °C
Operating Temperature	-40 to +85 °C

Outline Drawing

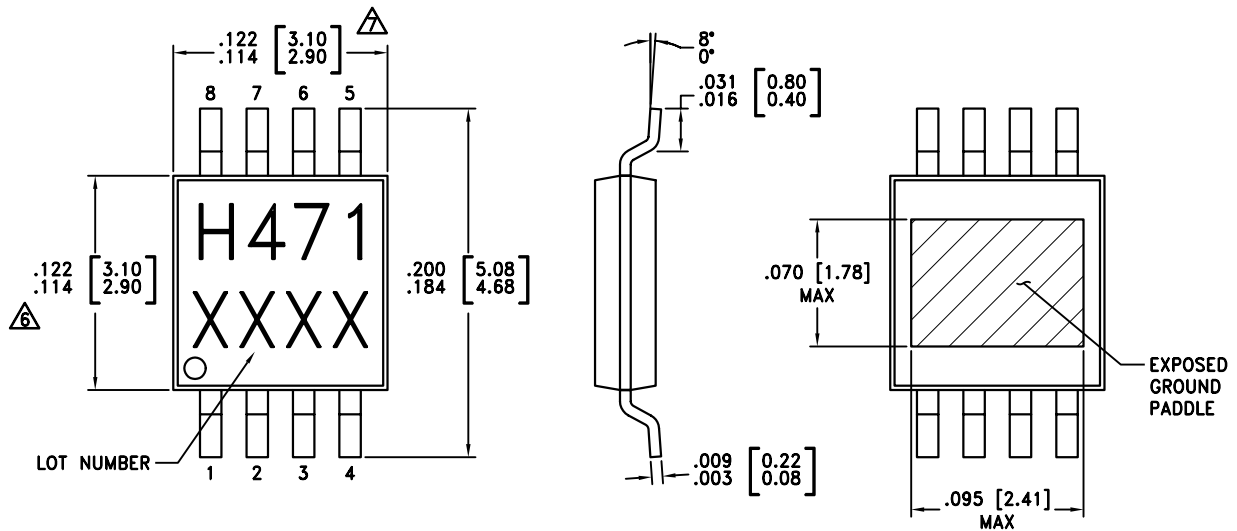



NOTES:

1. PACKAGE BODY MATERIAL: LOW STRESS INJECTION MOLDED PLASTIC SILICA AND SILICON IMPREGNATED.
2. LEAD AND GROUND PADDLE MATERIAL: COPPER ALLOY
3. LEAD AND GROUND PADDLE PLATING: Sn/Pb SOLDER
4. DIMENSIONS ARE IN INCHES [MILLIMETERS].
- △ DIMENSION DOES NOT INCLUDE MOLDFLASH OF 0.15mm PER SIDE.
- △ DIMENSION DOES NOT INCLUDE MOLDFLASH OF 0.25mm PER SIDE.
7. ALL GROUND LEADS AND GROUND PADDLE MUST BE SOLDERED TO PCB RF GROUND.

SiGe HBT DUAL CHANNEL GAIN BLOCK MMIC AMPLIFIER, DC - 5.0 GHz

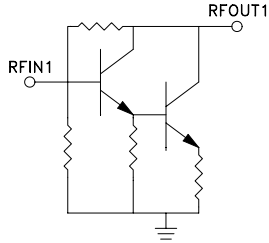
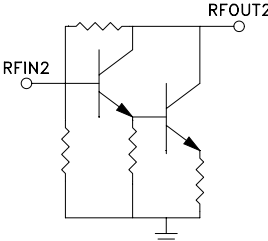
Pin Descriptions

Pin Number	Function	Description	Interface Schematic
1	RFIN1	This pin is DC coupled. An off chip DC blocking capacitor is required.	
8	RFOUT1	RF output and DC Bias (Vcc1) for the output stage.	
2, 3, 6, 7	N/C	No connection. These pins may be connected to RF ground. Performance will not be affected.	
4	RFIN2	This pin is DC coupled. An off chip DC blocking capacitor is required.	
5	RFOUT2	RF output and DC Bias (Vcc2) for the output stage.	
Ground Paddle	GND	Ground paddle must be connected to RF/DC ground.	

SiGe HBT DUAL CHANNEL GAIN BLOCK MMIC AMPLIFIER, DC - 5.0 GHz

Application Circuit for Balanced Operation

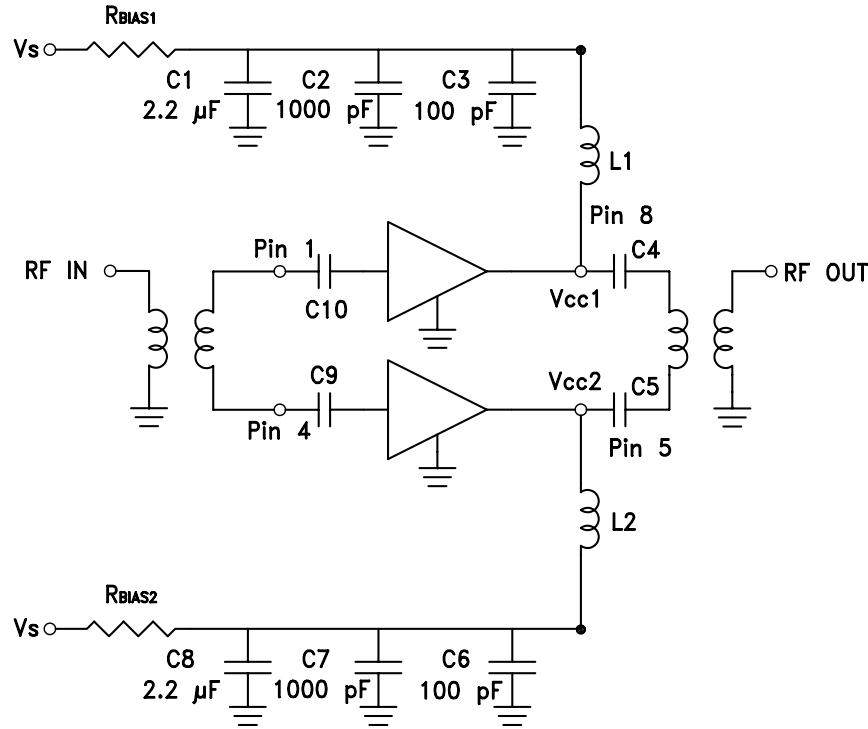

Note:

1. External blocking capacitors are required on RFIN and RFOUT.
2. RBIAS provides DC bias stability over temperature.

Recommended Bias Resistor Values for $I_{cc} = 75 \text{ mA}$, $R_{bias} = (V_s - V_{cc}) / I_{cc}$

Supply Voltage (Vs)	6V	8V	10V	12V
RBIAS VALUE	11 Ω	39 Ω	62 Ω	91 Ω
RBIAS POWER RATING	1/4 W	1/2 W	1/2 W	1 W

Recommended Component Values for Key Application Frequencies

Component	Frequency (MHz)						
	50	900	1900	2200	2400	3500	5000
L1, L2	270 nH	56 nH	18 nH	18 nH	15 nH	8.2 nH	6.8 nH
C4, C5, C9, C10	0.01 μF	100 pF	100 pF	100 pF	100 pF	100 pF	100 pF

SiGe HBT DUAL CHANNEL GAIN BLOCK MMIC AMPLIFIER, DC - 5.0 GHz

Evaluation PCB

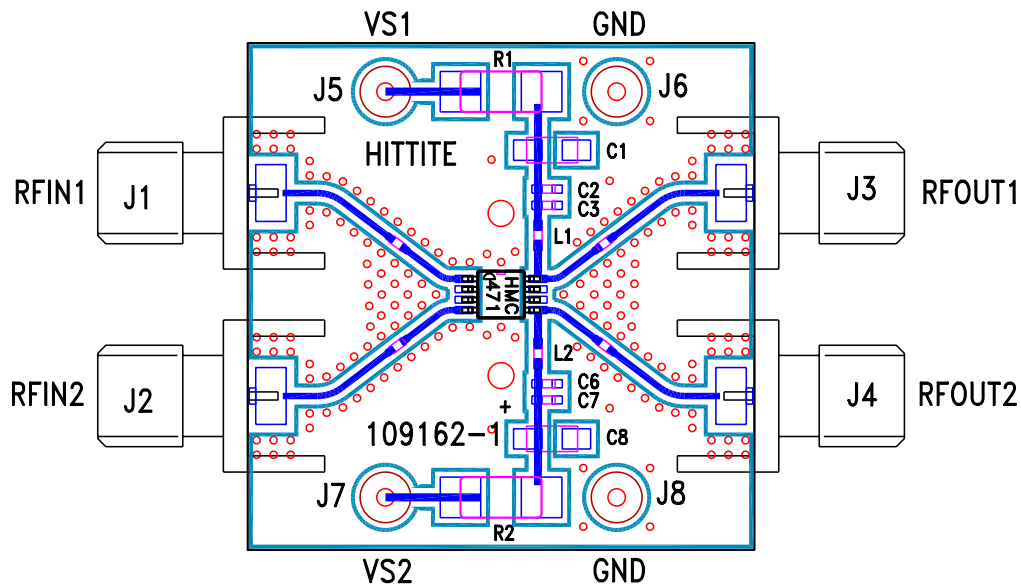

List of Materials for Evaluation PCB 109185*

Item	Description
J1 - J4	PC Mount SMA Connector
J5 - J8	DC Pins
L1, L2	Inductor, 0402 Pkg.
C1, C8	2.2 μ F Capacitor, Tantalum
C2, C7	1000 pF Capacitor, 0402 Pkg.
C3, C6	100 pF Capacitor, 0402 Pkg.
C4, C5, C9, C10	Capacitor, 0402 Pkg.
R1, R2	Resistor, 2010 Pkg.
U1	HMC471MS8G
PCB**	109162 Evaluation PCB
** Circuit Board Material: Rogers 4350	

The circuit board used in the final application should use RF circuit design techniques. Signal lines should have 50 ohm impedance while the package ground leads and package bottom should be connected directly to the ground plane similar to that shown. A sufficient number of VIA holes should be used to connect the top and bottom ground planes. The evaluation board should be mounted to an appropriate heat sink. The evaluation circuit board shown is available from Hittite upon request.

* Reference this number when ordering complete evaluation PCB.