

**Major Ratings and Characteristics**

Characteristics	MBR350 MBR360	Units
$I_{F(AV)}$ Rectangular waveform	3.0	A
$V_{RRM}$	50/60	V
$I_{FSM}$ @ $t_p = 5 \mu s$ sine	460	A
$V_F$ @3Apk, $T_J = 25^\circ C$	0.73	V
$T_J$	-40 to 150	$^\circ C$

**Description/Features**

The MBR350, MBR360 axial leaded Schottky rectifier has been optimized for very low forward voltage drop, with moderate leakage. Typical applications are in switching power supplies, converters, free-wheeling diodes, and reverse battery protection.

- Low profile, axial leaded outline
- High purity, high temperature epoxy encapsulation for enhanced mechanical strength and moisture resistance
- Very low forward voltage drop
- High frequency operation
- Guard ring for enhanced ruggedness and long term reliability

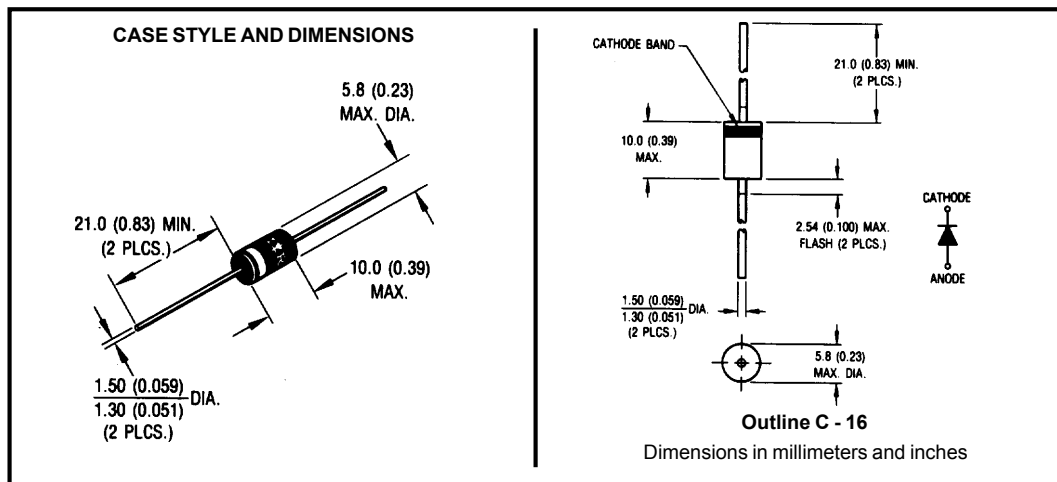

Voltage Ratings

Part number	MBR350	MBR360
V <sub>R</sub> Max. DC Reverse Voltage (V)	50	60
V <sub>RWM</sub> Max. Working Peak Reverse Voltage (V)		

Absolute Maximum Ratings

Parameters	Value	Units	Conditions
I <sub>F(AV)</sub> Max. Average Forward Current * See Fig. 4	3.0	A	50% duty cycle @ T <sub>L</sub> = 50°C, rectangular waveform
I <sub>FSM</sub> Max. Peak One Cycle Non-Repetitive Surge Current * See Fig. 6	460	A	5µs Sine or 3µs Rect. pulse
	80		10ms Sine or 6ms Rect. pulse
E <sub>AS</sub> Non-Repetitive Avalanche Energy	6.0	mJ	T <sub>J</sub> = 25 °C, I <sub>AS</sub> = 1 Amps, L = 10 mH
I <sub>AR</sub> Repetitive Avalanche Current	0.4	A	Current decaying linearly to zero in 1µsec Frequency limited by T <sub>J</sub> max. V <sub>A</sub> = 1.5 x V <sub>R</sub> typical

Electrical Specifications

Parameters	Value	Units	Conditions
V <sub>FM</sub> Max. Forward Voltage Drop * See Fig. 1 (1)	0.58	V	@ 1.0A
	0.73	V	@ 3.0A
	1.06	V	@ 9.4A
	0.49	V	@ 1.0A
	0.64	V	@ 3.0A
	0.89	V	@ 9.4A
I <sub>RM</sub> Max. Reverse Leakage Current * See Fig. 2 (1)	0.6	mA	T <sub>J</sub> = 25 °C
	8	mA	T <sub>J</sub> = 100 °C
	15	mA	T <sub>J</sub> = 125 °C
C <sub>T</sub> Typical Junction Capacitance	190	pF	V <sub>R</sub> = 5V <sub>DC</sub> (test signal range 100Khz to 1Mhz) 25°C
L <sub>S</sub> Typical Series Inductance	9.0	nH	Measured lead to lead 5mm from package body
dv/dt Max. Voltage Rate of Change	10000	V/µs	(Rated V <sub>R</sub> )

(1) Pulse Width < 300µs, Duty Cycle <2%

Thermal-Mechanical Specifications

Parameters	Value	Units	Conditions
T <sub>J</sub> Max. Junction Temperature Range (*)	-40 to 150	°C	
T <sub>stg</sub> Max. Storage Temperature Range	-40 to 150	°C	
R <sub>thJL</sub> Typical Thermal Resistance Junction to Lead (**)	30	°C/W	DC operation (* See Fig. 4)
wt Approximate Weight	1.2(0.042)	g(oz.)	
Case Style	C-16		

(\*)  $\frac{dP_{tot}}{dT_J} < \frac{1}{R_{th(j-a)}}$  thermal runaway condition for a diode on its own heatsink

(\*\*) Mounted 1 inch square PCB, thermal probe connected to lead 2mm from package

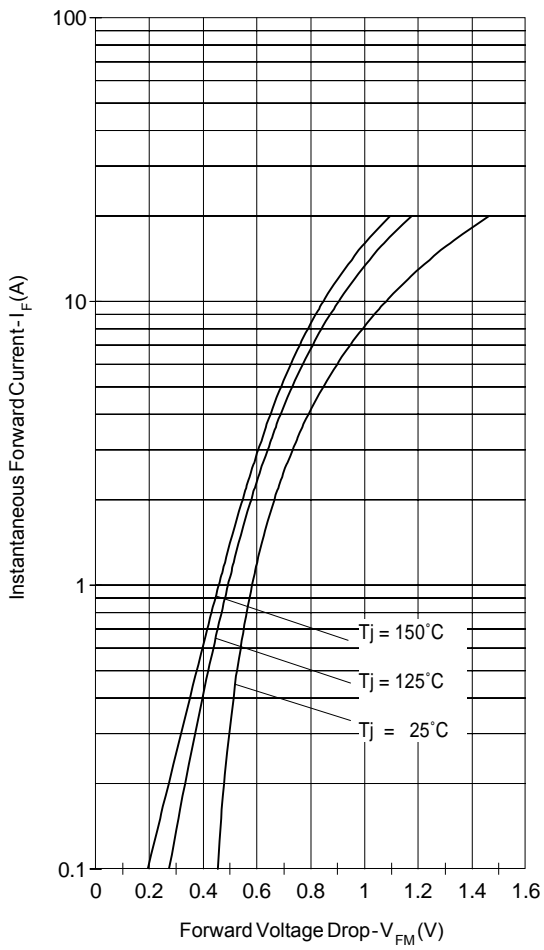

**Fig. 1 - Max. Forward Voltage Drop Characteristics**

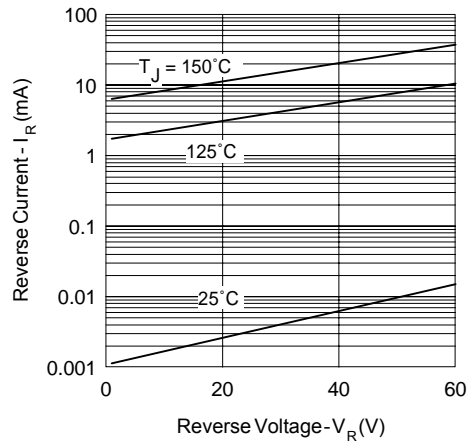

**Fig. 2 - Typical Values Of Reverse Current Vs. Reverse Voltage**

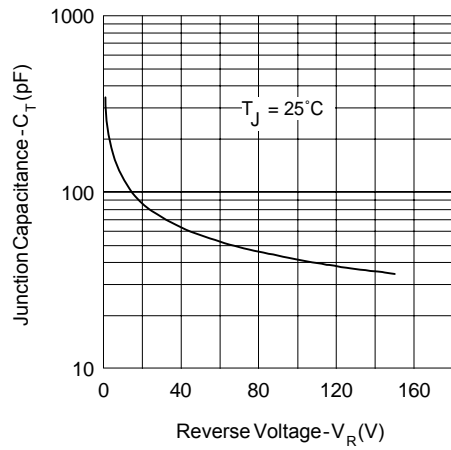

**Fig. 3 - Typical Junction Capacitance Vs. Reverse Voltage**

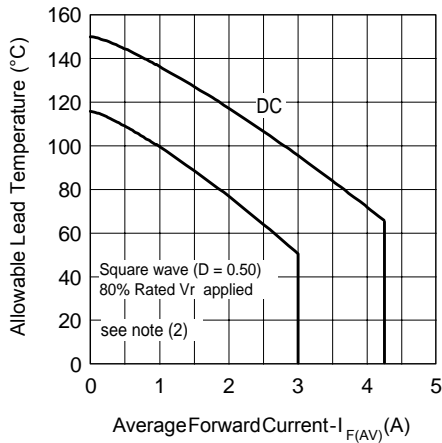

**Fig. 4 - Max. Allowable Lead Temperature Vs. Average Forward Current**

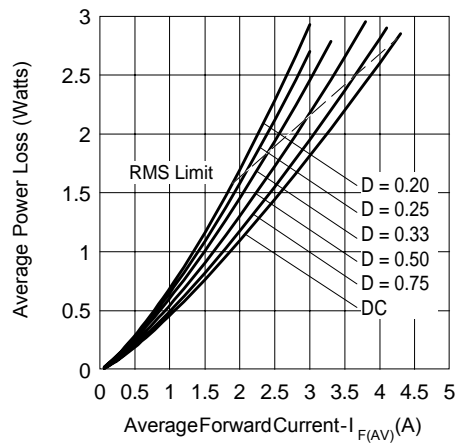

**Fig. 5 - Forward Power Loss Characteristics**

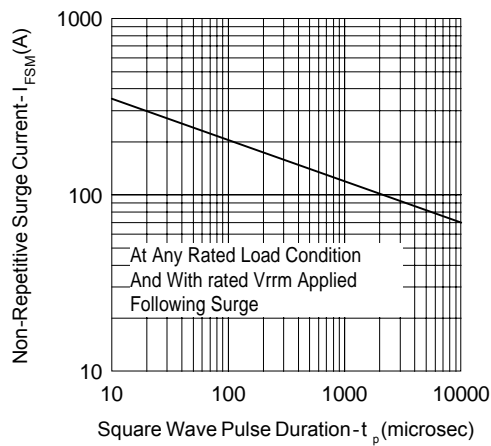

**Fig. 6 - Max. Non-Repetitive Surge Current**

(2) Formula used:  $T_c = T_j - (Pd + Pd_{REV}) \times R_{thJC}$ ;

$Pd$  = Forward Power Loss =  $I_{F(AV)} \times V_{FM} @ (I_{F(AV)} / D)$  (see Fig. 6);

$Pd_{REV}$  = Inverse Power Loss =  $V_{R1} \times I_R (1 - D)$ ;  $I_R @ V_{R1} = 80\%$  rated  $V_R$

Ordering Information Table

Device Code			
<b>MBR</b>	<b>3</b>	<b>60</b>	<b>TR</b>
①	②	③	④
<b>1</b>	- Schottky MBR Series		
<b>2</b>	- Current Rating: 3 = 3A		
<b>3</b>	- Voltage Rating		
<b>4</b>	- TR = Tape & Reel package (1200 pcs)		
	- = Box package (500 pcs)		

40 = 40V  
 60 = 60V

Data and specifications subject to change without notice.  
 This product has been designed and qualified for Industrial Level.  
 Qualification Standards can be found on IR's Web site.