

Control of Lithium Ion Batteries (switching regulator secondary) (two cells) Monolithic IC MM1357

Outline

This IC is used to control two-cell chargers and the secondary side of switching regulators; it features enhanced functions for current switching and for overcharge detection and other kinds of protection. The control output is capable of driving a photocoupler LED. The charging current can be switched between high and low currents, and each can also be varied externally.

Features

- | | |
|-----------------------------------------------------|-----------------------------------------------------------------------------------------|
| 1. Charging voltage | : Can be set externally |
| 2. switchable between high and low levels, variable | Charging current limit 1 High : 320mV typ.
Charging current limit 2 Low : 145mV typ. |
| 3. Reference voltage | : 1.207V typ. |

Package

SOP-14B

Applications

1. Switching regulator
2. AC adapter
3. Lithium ion battery charger

Block Diagram

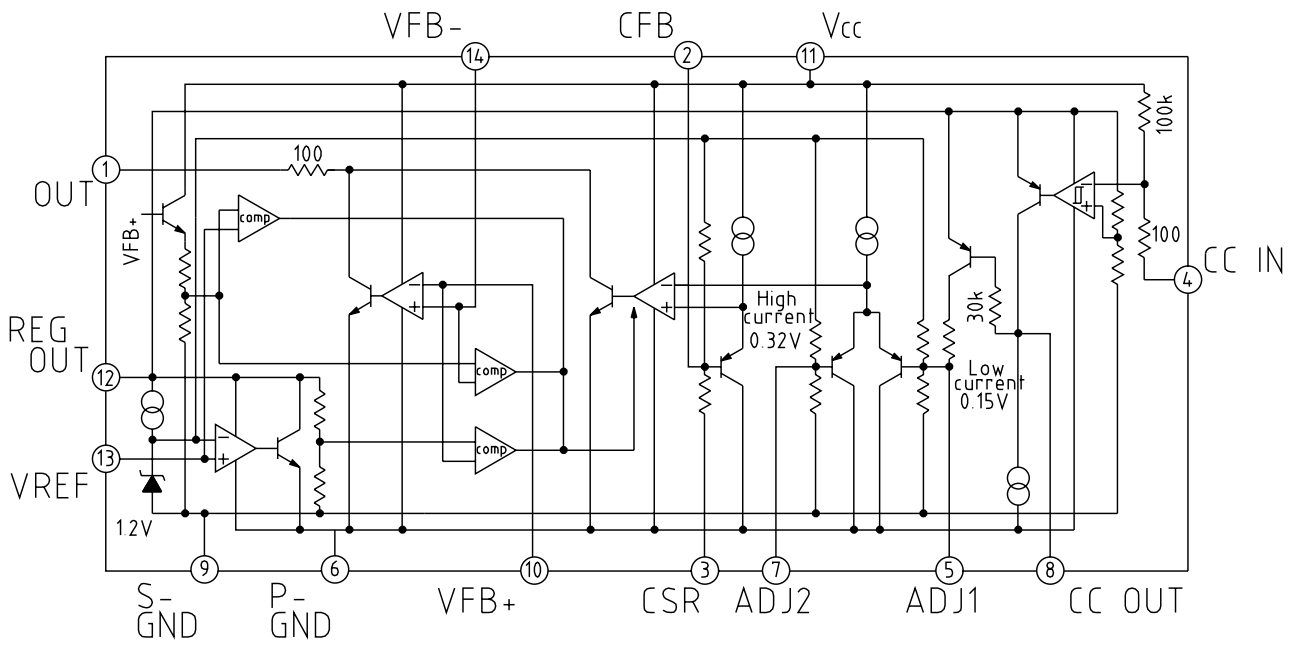

Pin Assignment

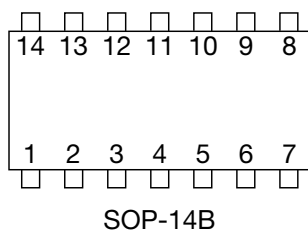

1	OUT	8	CC OUT
2	CFB	9	S-GND
3	CSR	10	VFB+
4	CC IN	11	Vcc
5	ADJ1	12	REG OUT
6	P-GND	13	VREF
7	ADJ2	14	VFB-

Pin Description

Pin no.	Pin name	Input/output	Function
1	OUT	Output	Output pin for charging control An external photocoupler is controlled for constant-current, constant-voltage charging control.
2	CFB	Input	Amp inverting input pin for current control An external capacitor (approx. 0.1 μ F) is connected between CFB and OUT, and phase compensation used to improve oscillation.
3	CSR	Input	Current detection pin Current is detected via the voltage drop across an external resistance between CSR and GND (R1), to control the charging current.
4	CC IN	Input	Charging current switching signal input pin H (Vcc) is the charging current 0.15V/R1, and L (GND) is the charging current 0.32V/R1. If for instance R1 is 0.1 Ω , then switching is between 1.5A and 3.2A (typ.). The switching voltage VTH is as follows. When REG OUT is 2.5V, VTH is 2.05V typ. When REG OUT is 4V, VTH is 3.0V typ. When REG OUT is 5V, VTH is 3.7V typ.
5	ADJ1	Input	Amp non-inverting input pin 1 for current control The pin voltage is set at 0.15V typ. With CC-IN at H or open, the non-inverting input pin of the current control amp is at 0.15 V. By adjusting the pin voltage using an external resistance or by other means, the charging current can be varied.
6	P-GND	Input	Power ground pin
7	ADJ2	Input	Amp non-inverting input pin 2 for current control The pin voltage is set at 0.32V typ. With CC-IN at L, the non-inverting input pin of the current control amp is at 0.32V. By adjusting the pin voltage using an external resistance or by other means, the charging current can be varied.
8	CC OUT	Output	Charging current switching signal output pin Output is in phase with CC IN. By connecting an external capacitor between CC OUT and REG OUT, a delay can be added only when the current switching CC IN goes from H to L. For instance, when REG OUT is 4V, on connecting an 0.1 μ F capacitor CC OUT becomes about 50mS (an example is shown in the Timing Chart section).
9	S-GND	Input	Signal ground pin
10	VFB+	Input	Amp non-inverting input pin for voltage control The charging voltage is set through the resistances at the VFB + pin and the VFB - pin.
11	Vcc	Input	Power supply input pin
12	REG OUT	Output	Reference voltage circuit output pin The reference voltage can be set between 2 and 6V. The input current to start the reference voltage should be set to 1mA or greater.
13	VREF	Input	Reference voltage circuit input pin The VREF pin voltage is set at 1.2V typ. The REG OUT voltage can be set through the resistances between REG OUT and VREF, and between VREF and GND. Amp inverter input pin for voltage control
14	VFB-	Input	Amp inverting input pin for voltage control The charging voltage can be set through the resistances at the VFB + pin and VFB - pin. By connecting an external capacitor (approx. 0.1 μ F) between VFB and OUT for phase compensation, oscillation can be improved.

Absolute Maximun Ratings

Item	Symbol	Ratings	Units
Storage temperature	T _{STG}	-40~+125	°C
Operating temperature	T _{OPR}	-20~+85	°C
Power supply voltage	V _{CC} max.	-0.3~+24	V
Allowable loss	P _D	350	mW

Recommended Operating Conditions

Item	Symbol	Ratings	Units
Operating temperature	T _{OPR}	-15~+80	°C
Operating voltage	V _{OPR}	+2~+20 *	V

*The minimum operating voltage is under constant-current control

Electrical Characteristics (Except where noted otherwise, Ta=25°C, REG OUT=4V, V_{CC}=8.4V)

Item	Symbol	Measurement conditions	Min.	Typ.	Max.	Units
V _{CC} minimum input current	I _{CC}	Excluding REG OUT input current		0.25	0.40	mA
Amp input for voltage control						
Input offset voltage	V _{IO}			1	5	mV
Input bias current VFB+	I _{B+}			20	250	nA
Input bias current VFB-	I _{B-}			20	250	nA
Common-mode input voltage range	V _I	*	0.7		REG OUT -0.7	V
Amp input for current control						
ADJ1 pin input impedance	R _{ADJ1}			13		kΩ
ADJ2 pin input impedance	R _{ADJ2}			13		kΩ
CFB pin input impedance	R _{CFB}			2		kΩ
Current limit 1	V _{CL1}	High-current mode	310	320	330	mV
Current limit 2	V _{CL2}	Low-current mode	137	145	153	mV
OUT pin input current 1	I _{S1}	OUT=8.4V (voltage-control amp)	20			mA
OUT pin input current 2	I _{S2}	OUT=4 V (voltage-control amp)	20			mA
OUT pin leakage current	I _L	OUT=24V		2		μA
CC IN input impedance	R _{CI}			100		kΩ
CC switching voltage L (High current mode)	V _{CL}				2.6	V
CC switching voltage H (Low current mode)	V _{CH}		3.4			V
CC OUT output intake current	I _{CO1}	On switching from low to high current mode		6		μA
CC OUT output current	I _{CO2}	On switching from high to low current mode		0.5		mA
CC OUT output voltage range	V _{CO}		0.4		3.6	V
Reference voltage	V _{REF}		1.195	1.207	1.219	V
REG OUT output voltage variable range	V _{REG}		2.0		6.0	V
REG OUT maximum input current	I _{max.}		20			mA
REG OUT minimum input current	I _{min.}				1.0	mA

*Because there is an internal circuit for protection against shorts of external components, the common-mode input voltage range is 0.7V to REG OUT-0.7V. Values are set such that overvoltages do not occur when there is a short between VFB+ and REG OUT or between VFB- and GND.

Timing Chart

Timing chart for connection of a timing capacitor C_T to CC OUT
 With REG OUT at 4V and C_T=0.1μF, TD is approx. 50mS.

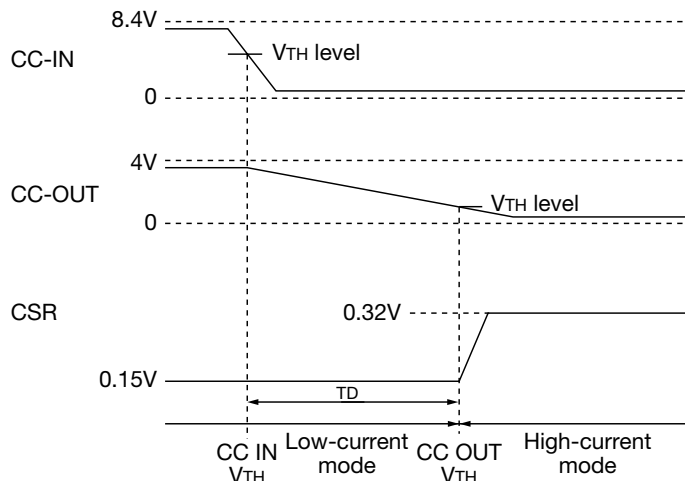

Application Circuits

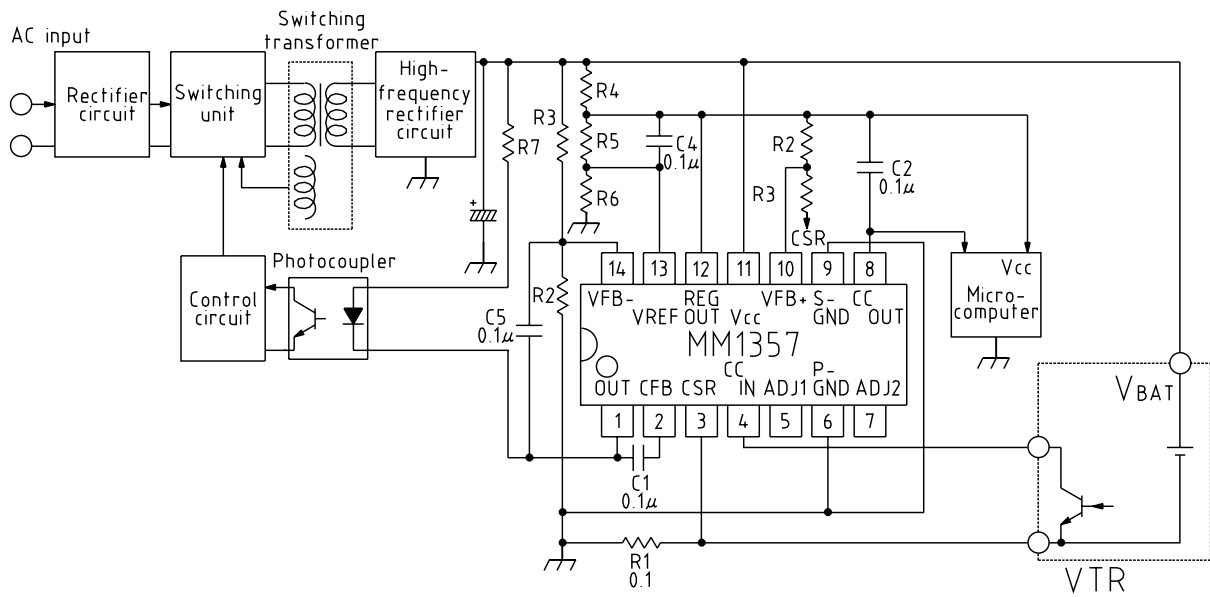

- Note 1 :
1. The REG OUT voltage can be set to $1.2V \text{ typ.} \times (R5+R6)/R6$. (REG OUT = 2 to 6V)
 2. The value of R4 should be set according to the load. (Consider it to be a shunt regulator.)
 3. The voltage under constant-voltage charging is equal to $(R3/R2) \times \text{REG OUT}$. When a high-precision voltage is required, use the knob for adjustment.
 4. The current in constant-current charging can be set to either of two values, $0.15V/R1$ (when CC-IN is H), and $0.32V/R1$ (when CC-IN is L).
 5. R7 is a resistance for current limiting.
 6. The capacitors C1 and C5 are to prevent oscillation; C4 is for soft starting of the REG OUT voltage; and C2 is used to delay current switching (CC-OUT switched from H to L).
- Note 2 : This IC incorporates a voltage-controlling amp and protection against shorting to VREF ; when R2, R3, R5 and R6 are shorted, the voltage is limited to its minimum value. By means of a comparator within the VFB+, VFB- and VREF pin area, upon resistance shorting the OUT pin is forced to L.
- Note 3 : Applicable circuits shown are typical examples provided for reference purposes. Mitsumi cannot assume responsibility for any problems arising out of the use of these circuits or for any infringement of third party patent and other right due to same.

Characteristics

■ Current limit 1 vs Ambient temperature

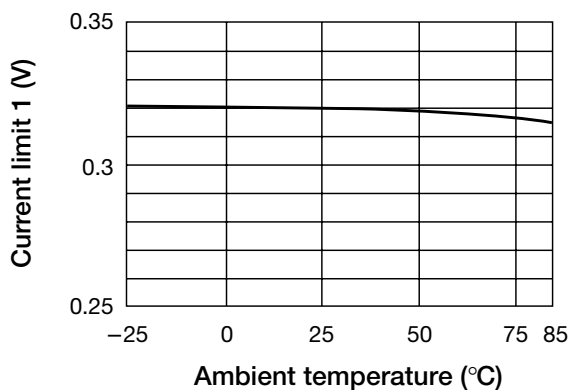

■ Current limit 2 vs Ambient temperature

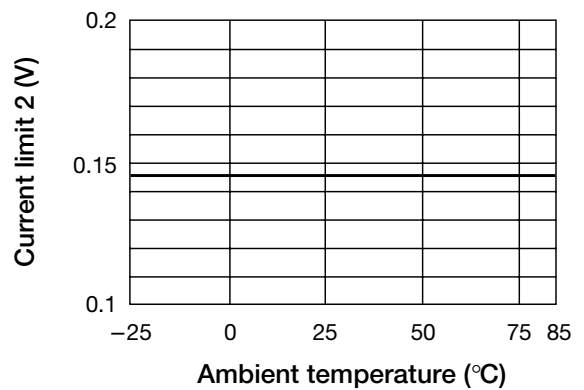

■ Reference voltage vs Ambient temperature

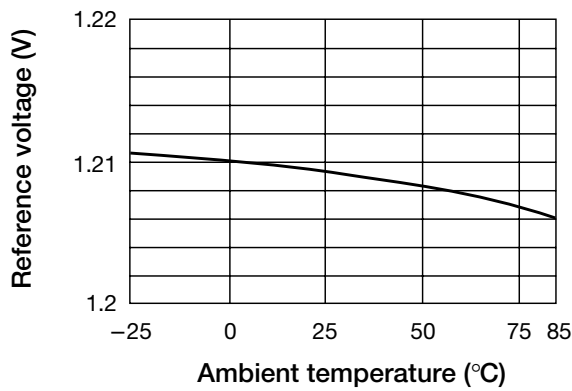

■ REG OUT voltage (4V) vs Ambient temperature

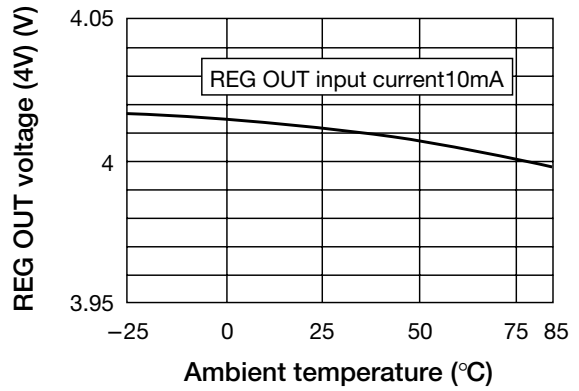

■ CC switching voltage vs Ambient temperature
REG OUT=4V

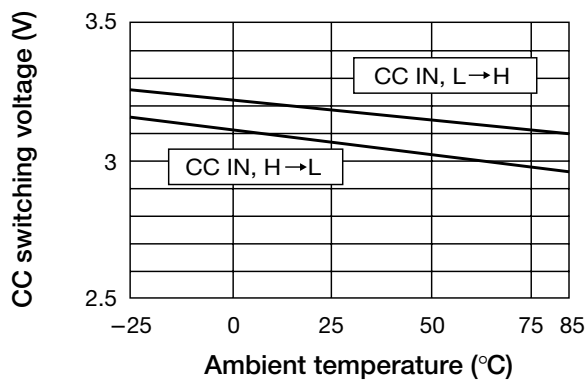

■ CC switching voltage vs REG OUT voltage

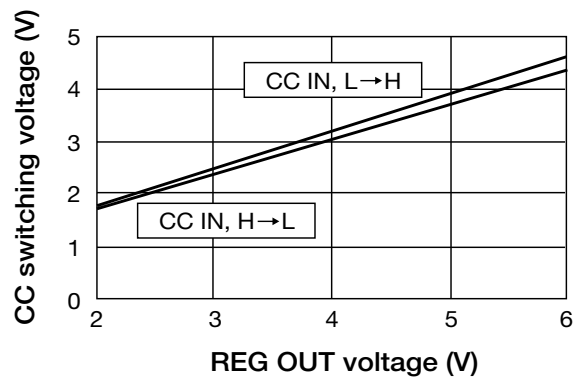

■ CC OUT vs DELAY TIME Ta=25°C REG OUT=4V
(CT is the capacitance between CC OUT and REG OUT)

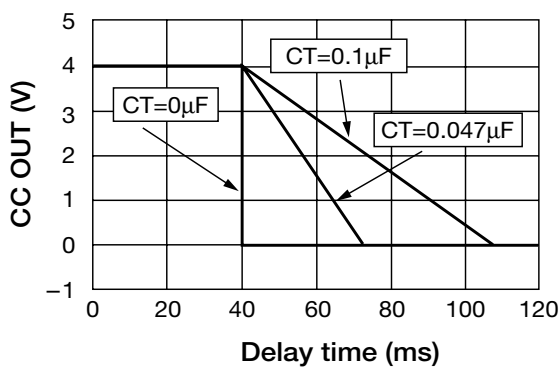

■ CC OUT intake current vs Ambient temperature

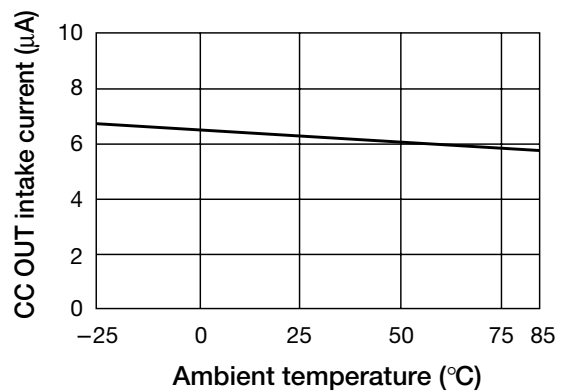

■ REG OUT voltage vs REG OUT input current Ta=25°C

