

CEP803AL/CEB803AL

March 1998

N-Channel Logic Level Enhancement Mode Field Effect Transistor

4

FEATURES

- 30V , 52A , $R_{DS(ON)}=15m\Omega$ @ $V_{GS}=10V$.
 $R_{DS(ON)}=25m\Omega$ @ $V_{GS}=4.5V$.
- Super high dense cell design for extremely low $R_{DS(ON)}$.
- High power and current handling capability.
- TO-220 & TO-263 package.

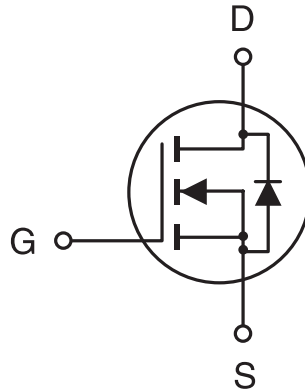

ABSOLUTE MAXIMUM RATINGS ($T_c=25^\circ C$ unless otherwise noted)

Parameter	Symbol	Limit	Unit
Drain-Source Voltage	V_{DS}	30	V
Gate-Source Voltage	V_{GS}	± 16	V
Drain Current-Continuous @ $T_J=125^\circ C$ -Pulsed	I_D	52	A
	I_{DM}	156	A
Drain-Source Diode Forward Current	I_S	52	A
Maximum Power Dissipation ^a @ $T_c=25^\circ C$ Derate above $25^\circ C$	P_D	75	W
		0.5	W/ $^\circ C$
Operating and Storage Temperature Range	T_J, T_{STG}	-65 to 175	$^\circ C$

THERMAL CHARACTERISTICS

Thermal Resistance, Junction-to-Case ^a	$R_{\theta JC}$	2	$^\circ C/W$
Thermal Resistance, Junction-to-Ambient ^a	$R_{\theta JA}$	62.5	$^\circ C/W$

CEP803AL/CEB803AL

4

ELECTRICAL CHARACTERISTICS (Tc=25°C unless otherwise noted)

Parameter	Symbol	Condition	Min	Typ	Max	Unit
OFF CHARACTERISTICS						
Drain-Source Breakdown Voltage	BV _{DSS}	V _{GS} =0V, I _D =250μA	30			V
Zero Gate Voltage Drain Current	I _{DSS}	V _{DS} =24V, V _{GS} =0V			10	μA
Gate-Body Leakage	I _{GSS}	V _{GS} =±16V, V _{DS} =0V			±100	nA
ON CHARACTERISTICS^a						
Gate Threshold Voltage	V _{GS(th)}	V _{DS} =V _{GS} , I _D =250μA	1	1.6	3	V
Drain-Source On-State Resistance	R _{DS(ON)}	V _{GS} =10V, I _D =26A		13	15	mΩ
		V _{GS} =4.5V, I _D =21A		20	25	mΩ
On-State Drain Current	I _{D(ON)}	V _{GS} =10V, V _{DS} =10V	60			A
Forward Transconductance	g _{FS}	V _{DS} =10V, I _D =26A		32		S
DYNAMIC CHARACTERISTICS^b						
Input Capacitance	C _{ISS}	V _{DS} =15V, V _{GS} =0V f=1.0MHz		1676	2200	pF
Output Capacitance	C _{OSS}			813	1200	pF
Reverse Transfer Capacitance	C _{RSS}			173	230	pF
SWITCHING CHARACTERISTICS^b						
Turn-On Delay Time	t _{D(ON)}	V _{DD} =15V, I _D =52A, V _{GS} =10V, R _{GEN} =24Ω		9	16	ns
Rise Time	t _r			190	250	ns
Turn-Off Delay Time	t _{D(OFF)}			60	90	ns
Fall Time	t _f			175	200	ns
Total Gate Charge	Q _g	V _{DS} =10V, I _D =52A, V _{GS} =10V		35	60	nC
Gate-Source Charge	Q _{gs}			8		nC
Gate-Drain Charge	Q _{gd}			5		nC

CEP803AL/CEB803AL

ELECTRICAL CHARACTERISTICS ($T_c=25^\circ\text{C}$ unless otherwise noted)

Parameter	Symbol	Condition	Min	Typ	Max	Unit
DRAIN-SOURCE DIODE CHARACTERISTICS ^a						
Diode Forward Voltage	V_{SD}	$V_{GS} = 0V, I_s = 26A$		0.86	1.2	V

Notes

- a. Pulse Test: Pulse Width $\leq 300 \mu s$, Duty Cycle $\leq 2\%$.
- b. Guaranteed by design, not subject to production testing.

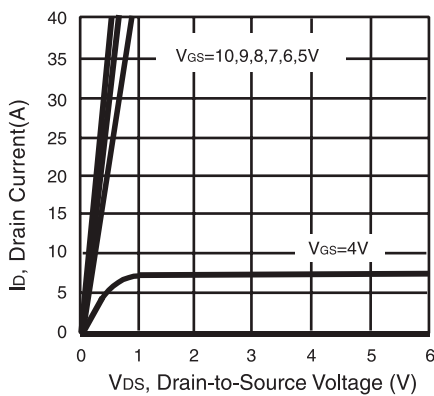

Figure 1. Output Characteristics

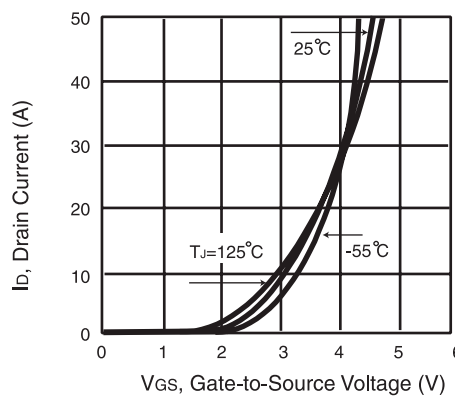

Figure 2. Transfer Characteristics

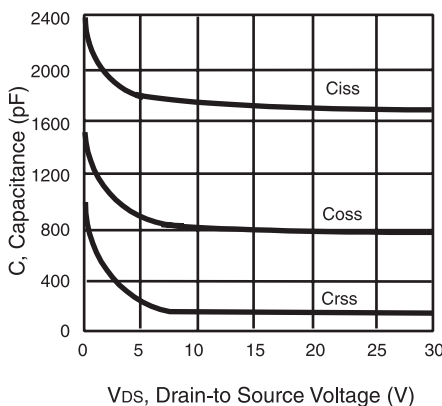

Figure 3. Capacitance

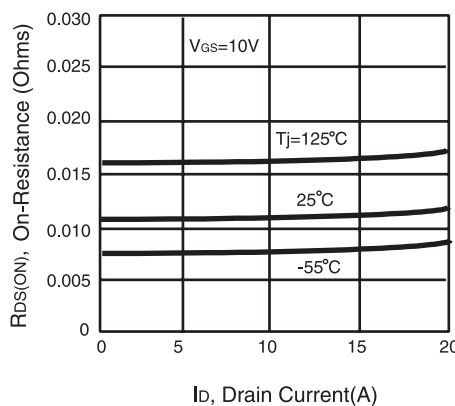

Figure 4. On-Resistance Variation with Drain Current and Temperature

CEP803AL/CEB803AL

4

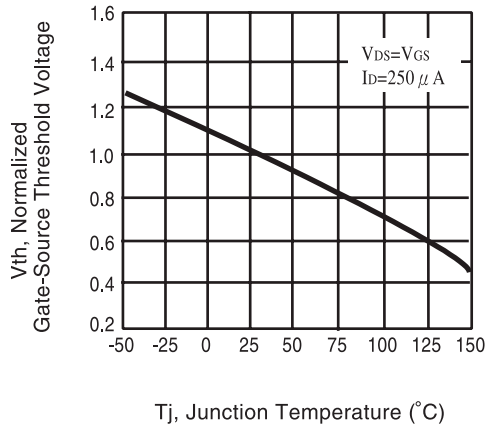

Figure 5. Gate Threshold Variation with Temperature

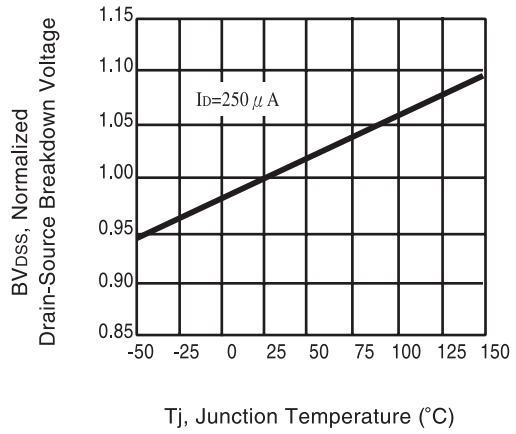

Figure 6. Breakdown Voltage Variation with Temperature

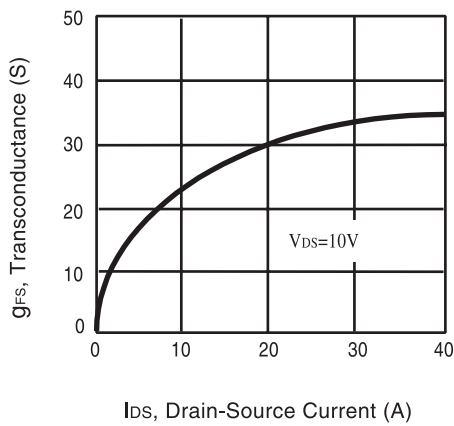

Figure 7. Transconductance Variation with Drain Current

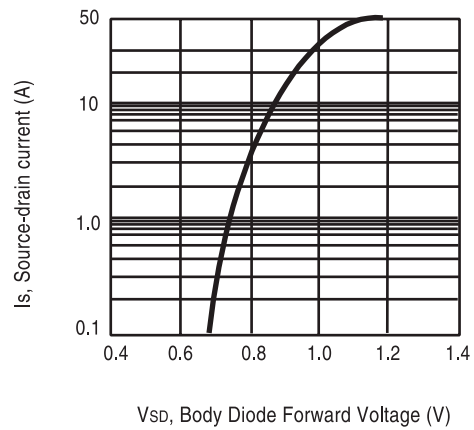

Figure 8. Body Diode Forward Voltage Variation with Source Current

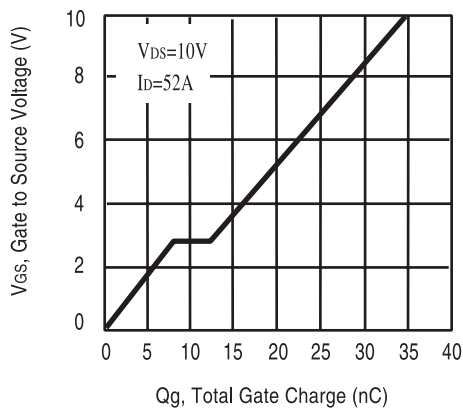

Figure 9. Gate Charge

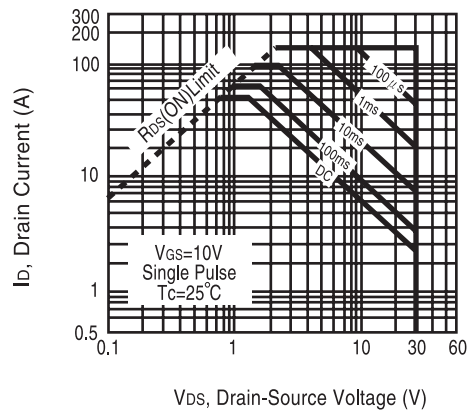

Figure 10. Maximum Safe Operating Area

CEP803AL/CEB803AL

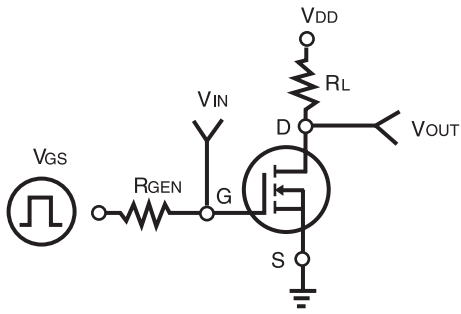

Figure 11. Switching Test Circuit

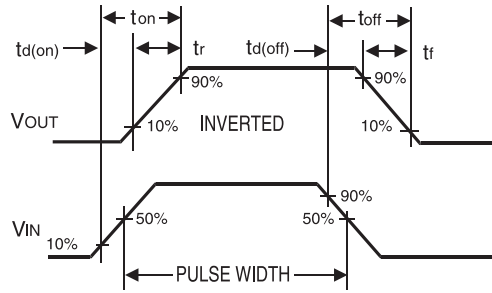

Figure 12. Switching Waveforms

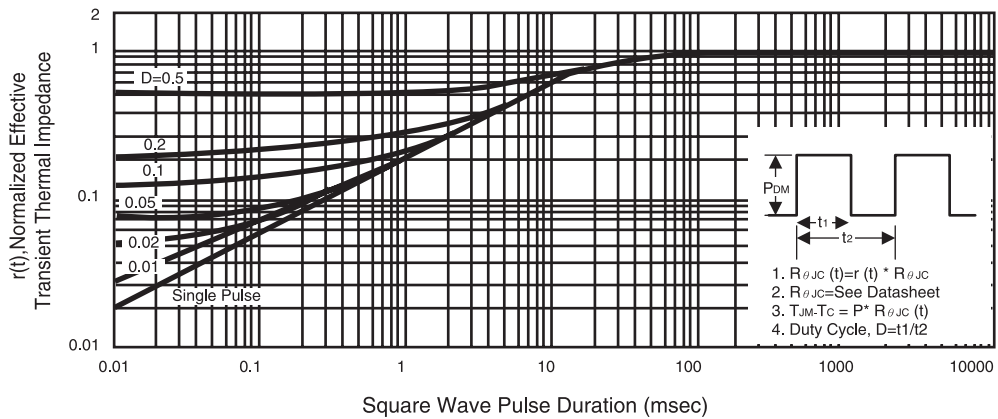

Figure 13. Normalized Thermal Transient Impedance Curve