

HEXFRED™

Ultrafast, Soft Recovery Diode

Features

- Fast Recovery Time Characteristic
- Electrically Isolated Base Plate
- Large Creepage Distance Between Terminal
- Simplified Mechanical Designs, Rapid Assembly

$V_R = 1200V$
$V_{F(typ)} = 2.6V$
$I_{F(AV)} = 80A$
$t_{rr (typ)} = 25ns$

Description/ Applications

The dual diode series configuration (HFA80FA120) is used for output rectification or freewheeling/ clamping operation and high voltage application. The semiconductor in the SOT-227 package is isolated from the copper base plate, allowing for common heatsinks and compact assemblies to be built. These modules are intended for general applications such as HV power supplies, electronic welders, motor control and inverters.

Absolute Maximum Ratings

Parameters	Max	Units
V_R Cathode-to-Anode Voltage	1200	V
I_F Continuous Forward Current, $T_C = 60^\circ C$ Per Leg	40	A
I_{FSM} Single Pulse Forward Current, $T_J = 25^\circ C$ Per Leg	400	
I_{FRM} Maximum Repetitive Forward Current, Rated V_R , Square wave, 20KHz, $T_C = 60^\circ C$	72	
P_D Max Power Dissipation, $T_C = 100^\circ C$	71	W
	Max Power Dissipation, $T_C = 25^\circ C$	
V_{ISOL} RMS Isolation Voltage, Any Terminal to Case, $t = 1$ min	2500	V
T_J, T_{STG} Operating Junction and Storage Temperatures	- 55 to 150	$^\circ C$

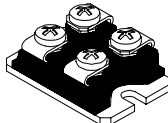
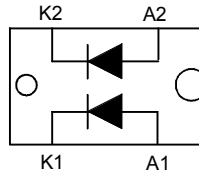
Case Styles	
HFA80FA120	
	
SOT-227	

Electrical Characteristics @ T_J = 25°C (unless otherwise specified)

Parameters		Min	Typ	Max	Units	Test Conditions
V _{BR}	Cathode Anode Breakdown Voltage	1200	-	-	V	I _R = 100μA
V _{FM}	Forward Voltage	-	2.6	3.0	V	I _F = 25A Fig. 1
		-	2.9	3.3	V	I _F = 40A
		-	3.4	-	V	I _F = 80A, T _J = 125°C
I _{RM}	Reverse Leakage Current	-	2.0	-	μA	V _R = V _R Rated Fig. 2
		-	0.5	2	mA	T _J = 125°C, V _R = 0.8 x V _R Rated
C _T	Junction Capacitance	-	43	-	pF	V _R = 200V Fig. 3

Dynamic Recovery Characteristics @ T_C = 25°C (unless otherwise specified)

Parameters		Min	Typ	Max	Units	Test Conditions
t _{rr}	Reverse Recovery Time	-	25	-	ns	I _F = 1A, di _F /dt = 200A/μs, V _R = 30V
		-	52	-		T _J = 25°C
		-	110	-		T _J = 125°C
I _{RRM}	Peak Recovery Current	-	5.9	-	A	T _J = 25°C
		-	10.8	-		T _J = 125°C
Q _{rr}	Reverse Recovery Charge	-	160	-	nC	T _J = 25°C
		-	630	-		T _J = 125°C

I_F = 40A
di_F/dt = -200A/μs
V_R = 200V

Thermal - Mechanical Characteristics

Parameters		Min	Typ	Max	Units
R _{thJC}	Junction to Case, Single Leg Conducting			0.7	°C/W
	Both Leg Conducting			0.35	K/W
R _{thCS}	Case to Heat Sink, Flat, Greased Surface		0.05		
Wt	Weight		30		g
T	Mounting Torque		1.3		(N*m)

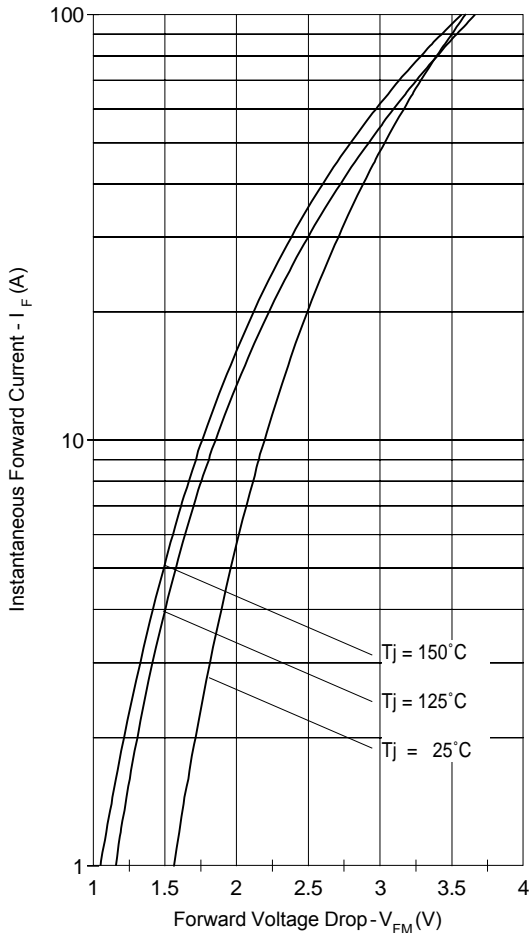

Fig. 1 - Typical Forward Voltage Drop Characteristics

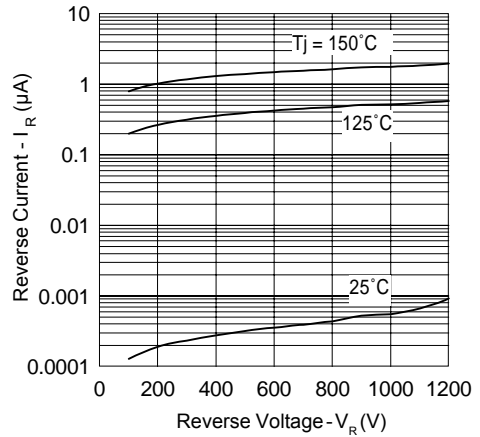

Fig. 2 - Typical Values Of Reverse Current Vs. Reverse Voltage

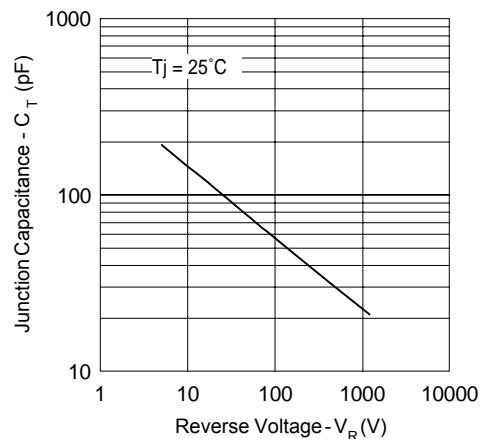

Fig. 3 - Typical Junction Capacitance Vs. Reverse Voltage

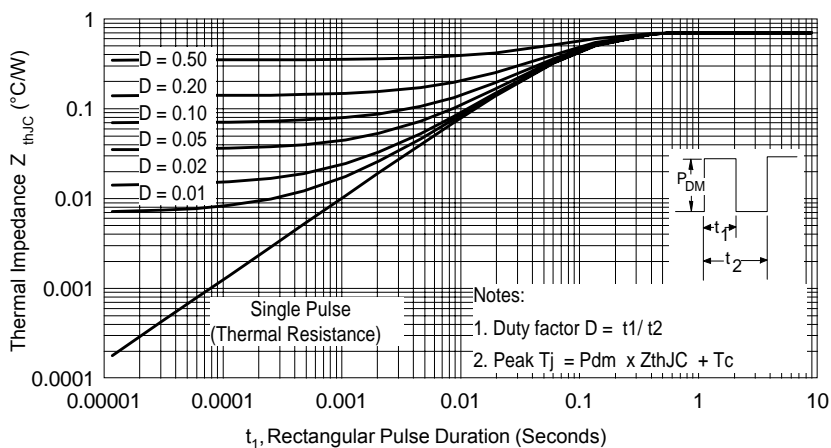

Fig. 4 - Max. Thermal Impedance Z_{thJC} Characteristics

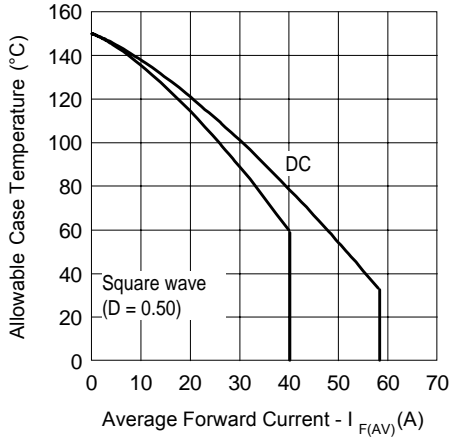

Fig. 5 - Max. Allowable Case Temperature Vs. Average Forward Current

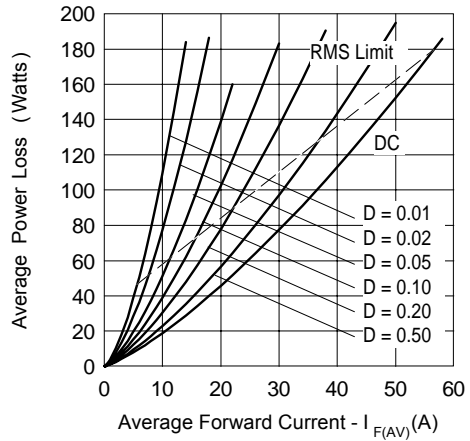

Fig. 6 - Forward Power Loss Characteristics

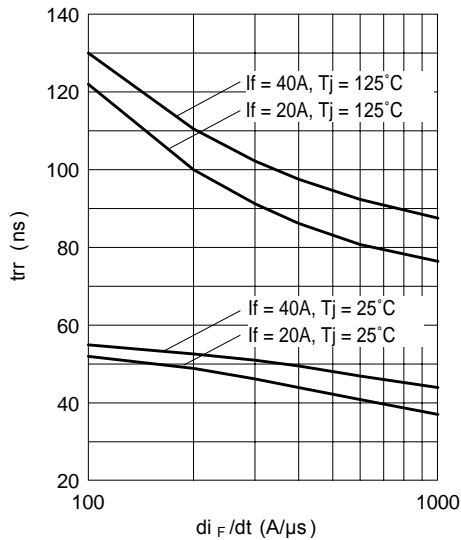

Fig. 7 - Typical Reverse Recovery vs. di_F/dt

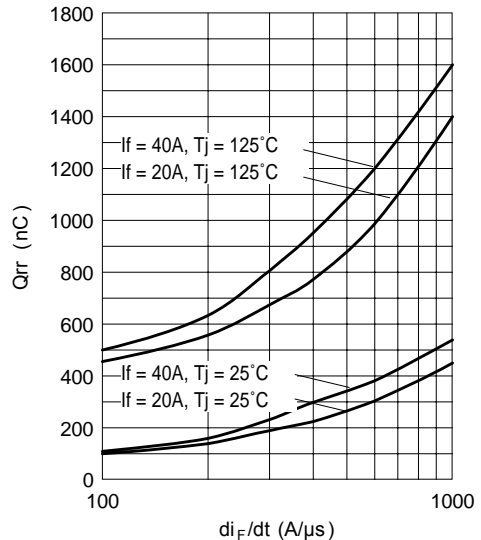
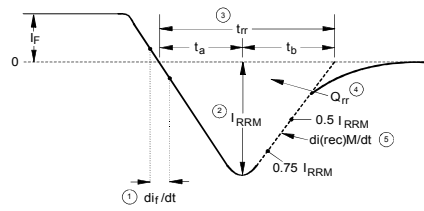
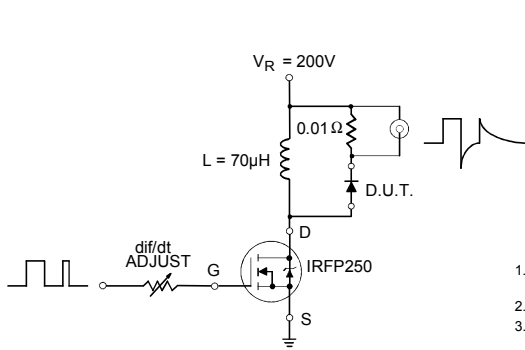

Fig. 8 - Typical Stored Charge vs. di_F/dt

(3) Formula used: $T_c = T_j - (Pd + Pd_{REV}) \times R_{thJC}$

Pd = Forward Power Loss = $I_{F(AV)} \times V_{FM} @ (I_{F(AV)}/D)$ (see Fig. 6);

Pd_{REV} = Inverse Power Loss = $V_{R1} \times I_R (1 - D)$; $I_R @ V_{R1}$ = rated V_R



1. di_F/dt - Rate of change of current through zero crossing
2. I_{RRM} - Peak reverse recovery current
3. t_{rr} - Reverse recovery time measured from zero crossing point of negative going I_F to point where a line passing through $0.75 I_{RRM}$ and $0.50 I_{RRM}$ extrapolated to zero current
4. Q_{rr} - Area under curve defined by t_{rr} and I_{RRM}

$$Q_{rr} = \frac{t_{rr} \times I_{RRM}}{2}$$
5. $di_{(rec)M}/dt$ - Peak rate of change of current during t_b portion of t_{rr}

Fig. 9 - Reverse Recovery Parameter Test Circuit

Fig. 10 - Reverse Recovery Waveform and Definitions

SOT-227 Package Details

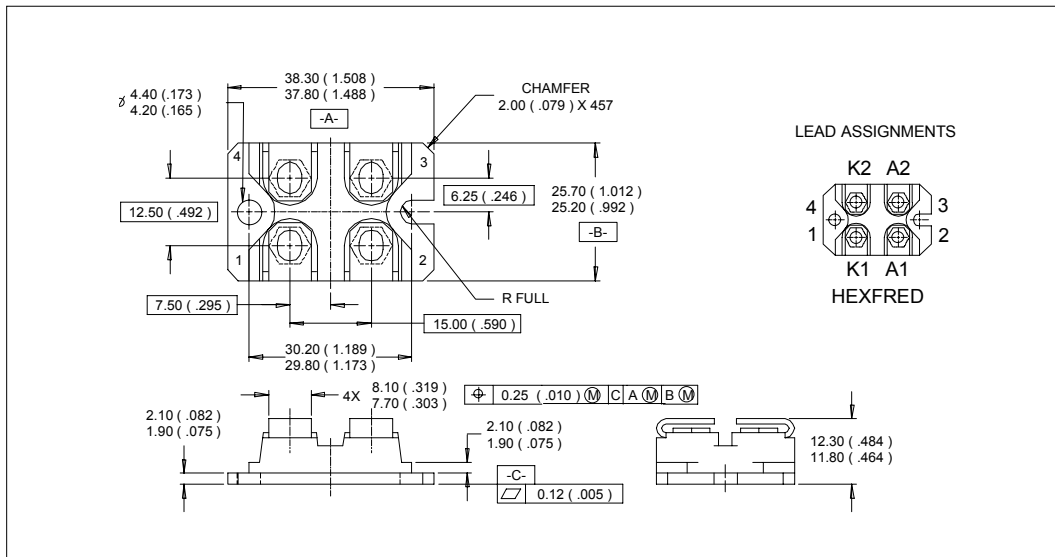

SOT-227 Package Details

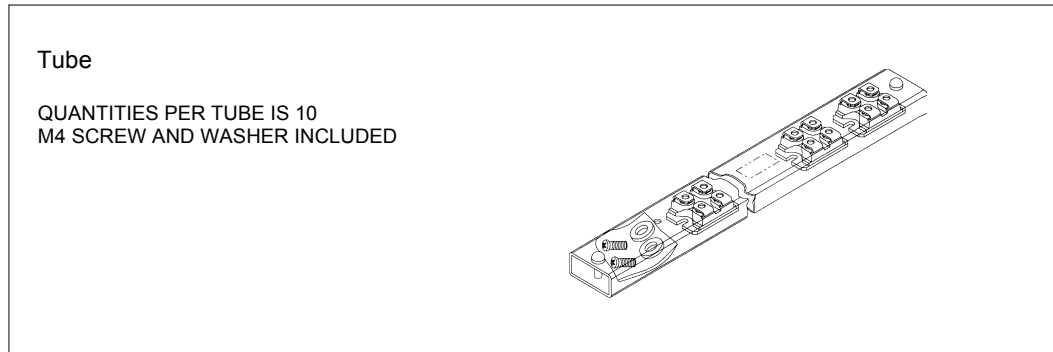

Ordering Information Table

Device Code																
	<table border="1" style="display: inline-table; border-collapse: collapse;"> <tr> <td style="padding: 5px;">HF</td> <td style="padding: 5px;">A</td> <td style="padding: 5px;">80</td> <td style="padding: 5px;">FA</td> <td style="padding: 5px;">120</td> </tr> </table>	HF	A	80	FA	120										
HF	A	80	FA	120												
	<table style="display: inline-table; border: none;"> <tr> <td style="text-align: center; padding: 0 5px;">①</td> <td style="text-align: center; padding: 0 5px;">②</td> <td style="text-align: center; padding: 0 5px;">③</td> <td style="text-align: center; padding: 0 5px;">④</td> <td style="text-align: center; padding: 0 5px;">⑤</td> </tr> </table>	①	②	③	④	⑤										
①	②	③	④	⑤												
<table style="border: none;"> <tr><td style="background-color: black; color: white; padding: 2px 5px;">1</td><td style="padding: 0 5px;">-</td><td>Hexfred Family</td></tr> <tr><td style="background-color: black; color: white; padding: 2px 5px;">2</td><td style="padding: 0 5px;">-</td><td>Process Designator (A = Electron Irradiated)</td></tr> <tr><td style="background-color: black; color: white; padding: 2px 5px;">3</td><td style="padding: 0 5px;">-</td><td>Average Current (80 = 80A)</td></tr> <tr><td style="background-color: black; color: white; padding: 2px 5px;">4</td><td style="padding: 0 5px;">-</td><td>Package Outline (FA = SOT-227)</td></tr> <tr><td style="background-color: black; color: white; padding: 2px 5px;">5</td><td style="padding: 0 5px;">-</td><td>Voltage Rating (120 = 1200V)</td></tr> </table>	1	-	Hexfred Family	2	-	Process Designator (A = Electron Irradiated)	3	-	Average Current (80 = 80A)	4	-	Package Outline (FA = SOT-227)	5	-	Voltage Rating (120 = 1200V)	
1	-	Hexfred Family														
2	-	Process Designator (A = Electron Irradiated)														
3	-	Average Current (80 = 80A)														
4	-	Package Outline (FA = SOT-227)														
5	-	Voltage Rating (120 = 1200V)														

Data and specifications subject to change without notice.
This product has been designed and qualified for Industrial Level.
Qualification Standards can be found on IR's Web site.