

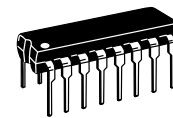

MC74AC352 MC74ACT352

DUAL 4-INPUT
MULTIPLEXER



N SUFFIX
CASE 648-08
PLASTIC

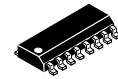

D SUFFIX
CASE 751B-05
PLASTIC

Dual 4-Input Multiplexer

The MC74AC352/74ACT352 is a very high-speed dual 4-input multiplexer with common Select inputs and individual Enable inputs for each section. It can select two bits of data from four sources. The two buffered outputs present data in the inverted (complementary) form. The MC74AC352/74ACT352 is the functional equivalent of the MC74AC153/74ACT153 except with inverted outputs.

- Inverted Version of the MC74AC153/74ACT153
- Separate Enables for Each Multiplexer
- Outputs Source/Sink 24 mA
- 'ACT352 Has TTL Compatible Inputs

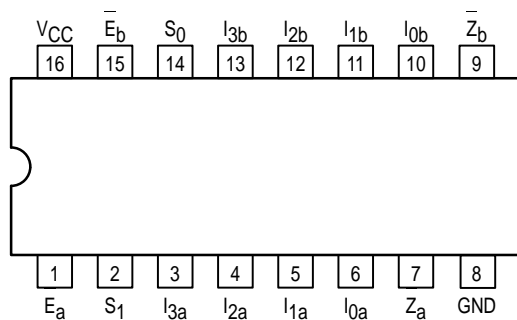

PIN NAMES

- I_{0a} - I_{3a} Side A Data Inputs
- I_{0b} - I_{3b} Side B Data Inputs
- S_0, S_1 Common Select Inputs
- E_a Side A Enable Input
- E_b Side B Enable Input
- Z_a, Z_b Multiplexer Outputs

TRUTH TABLE

| Select Inputs | | \bar{E} | Inputs (a or b) | | | | \bar{Z} |
|---------------|-------|-----------|-----------------|-------|-------|-------|-----------|
| S_0 | S_1 | | I_0 | I_1 | I_2 | I_3 | |
| X | X | H | X | X | X | X | H |
| L | L | L | L | X | X | X | H |
| L | L | L | H | X | X | X | L |
| H | L | L | X | L | X | X | H |
| H | L | L | X | H | X | X | L |
| L | H | L | X | X | L | X | H |
| L | H | L | X | X | H | X | L |
| H | H | L | X | X | X | L | H |
| H | H | L | X | X | X | H | L |

H = HIGH Voltage Level
L = LOW Voltage Level
X = Immaterial

LOGIC SYMBOL

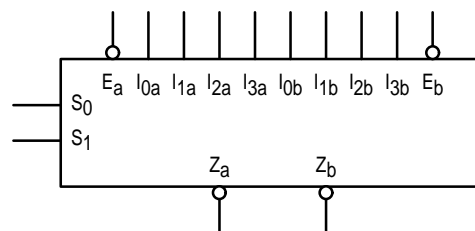

MC74AC352 MC74ACT352

FUNCTIONAL DESCRIPTION

The MC74AC352/74ACT352 is a dual 4-input multiplexer. It selects two bits of data from up to four sources under the control of the common Select inputs (S_0, S_1). The two 4-input multiplexer circuits have individual active LOW Enables (E_a, E_b) which can be used to strobe the outputs independently. When the Enables (E_a, E_b) are HIGH, the corresponding outputs (Z_a, Z_b) are forced HIGH.

The logic equations for the outputs are shown below:

$$\begin{aligned} \bar{Z}_a &= \bar{E}_a \cdot (I_{0a} \cdot \bar{S}_1 \cdot \bar{S}_0 + I_{1a} \cdot \bar{S}_1 \cdot S_0 + \\ &\quad I_{2a} \cdot S_1 \cdot \bar{S}_0 + I_{3a} \cdot S_1 \cdot S_0) \\ \bar{Z}_b &= \bar{E}_b \cdot (I_{0b} \cdot \bar{S}_1 \cdot \bar{S}_0 + I_{1b} \cdot \bar{S}_1 \cdot S_0 + \\ &\quad I_{2b} \cdot S_1 \cdot \bar{S}_0 + I_{3b} \cdot S_1 \cdot S_0) \end{aligned}$$

The MC74AC352/74ACT352 can be used to move data from a group of registers to a common output bus. The particular register from which the data came would be determined by the state of the Select inputs. A less obvious application is as a function generator. The MC74AC352/74ACT352 can generate two functions of three variables. This is useful for implementing highly irregular random logic.

LOGIC DIAGRAM

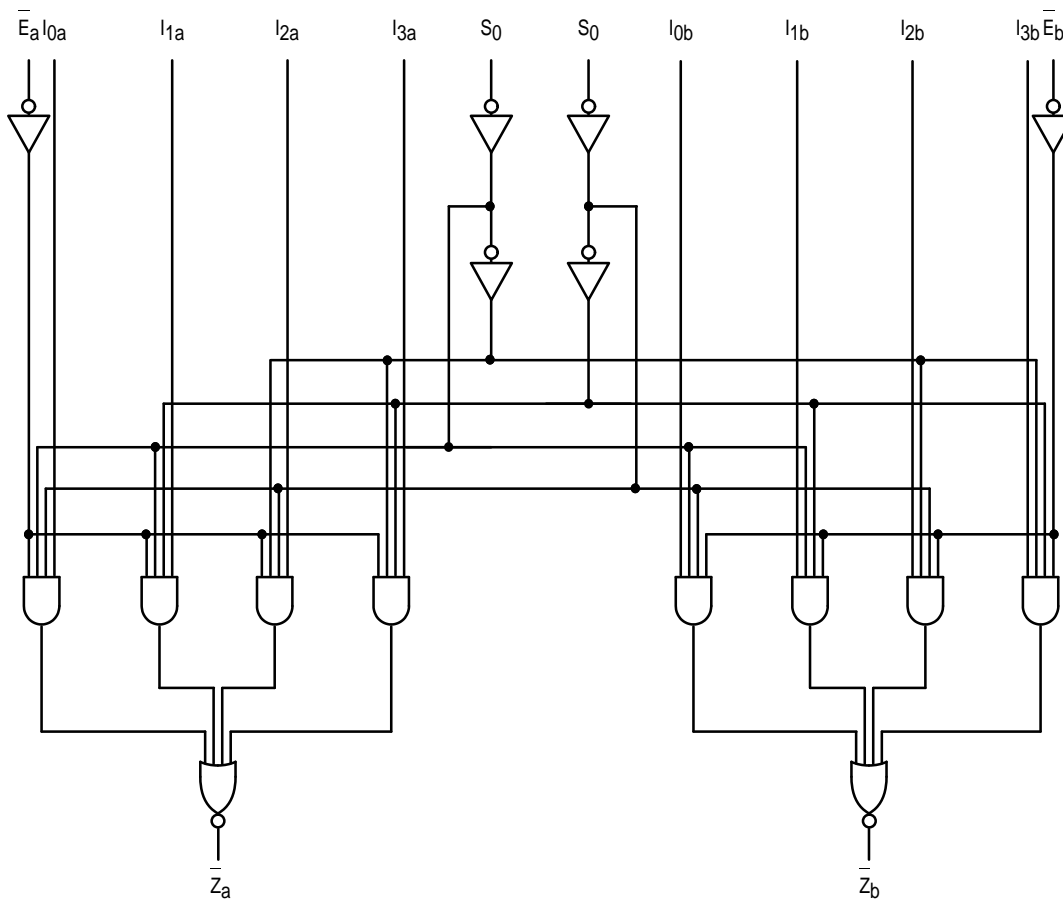

Please note that this diagram is provided only for the understanding of logic operations and should not be used to estimate propagation delays.

MC74AC352 MC74ACT352

MAXIMUM RATINGS*

| Symbol | Parameter | Value | Unit |
|-----------|---|------------------------|--------------------|
| V_{CC} | DC Supply Voltage (Referenced to GND) | -0.5 to +7.0 | V |
| V_{in} | DC Input Voltage (Referenced to GND) | -0.5 to $V_{CC} + 0.5$ | V |
| V_{out} | DC Output Voltage (Referenced to GND) | -0.5 to $V_{CC} + 0.5$ | V |
| I_{in} | DC Input Current, per Pin | ± 20 | mA |
| I_{out} | DC Output Sink/Source Current, per Pin | ± 50 | mA |
| I_{CC} | DC V_{CC} or GND Current per Output Pin | ± 50 | mA |
| T_{stg} | Storage Temperature | -65 to +150 | $^{\circ}\text{C}$ |

* Maximum Ratings are those values beyond which damage to the device may occur. Functional operation should be restricted to the Recommended Operating Conditions.

RECOMMENDED OPERATING CONDITIONS

| Symbol | Parameter | Min | Typ | Max | Unit | |
|-------------------|---|------------------|-----|----------|--------------------|------|
| V_{CC} | Supply Voltage | 'AC | 2.0 | 5.0 | 6.0 | V |
| | | 'ACT | 4.5 | 5.0 | 5.5 | |
| V_{in}, V_{out} | DC Input Voltage, Output Voltage (Ref. to GND) | 0 | | V_{CC} | V | |
| t_r, t_f | Input Rise and Fall Time (Note 1) 'AC Devices except Schmitt Inputs | V_{CC} @ 3.0 V | | 150 | | ns/V |
| | | V_{CC} @ 4.5 V | | 40 | | |
| | | V_{CC} @ 5.5 V | | 25 | | |
| t_r, t_f | Input Rise and Fall Time (Note 2) 'ACT Devices except Schmitt Inputs | V_{CC} @ 4.5 V | | 10 | | ns/V |
| | | V_{CC} @ 5.5 V | | 8.0 | | |
| T_J | Junction Temperature (PDIP) | | | 140 | $^{\circ}\text{C}$ | |
| T_A | Operating Ambient Temperature Range | -40 | 25 | 85 | $^{\circ}\text{C}$ | |
| I_{OH} | Output Current — High | | | -24 | mA | |
| I_{OL} | Output Current — Low | | | 24 | mA | |

1. V_{in} from 30% to 70% V_{CC} ; see individual Data Sheets for devices that differ from the typical input rise and fall times.

2. V_{in} from 0.8 V to 2.0 V; see individual Data Sheets for devices that differ from the typical input rise and fall times.

MC74AC352 MC74ACT352

DC CHARACTERISTICS

| Symbol | Parameter | V _{CC} (V) | 74AC | | 74AC | | Unit | Conditions |
|------------------|--------------------------------------|------------------------|------------------------|-------------------|------------------------------------|----|---|------------|
| | | | T _A = +25°C | | T _A = -40°C to +85°C | | | |
| | | | Typ | Guaranteed Limits | | | | |
| V _{IH} | Minimum High Level Input Voltage | 3.0 | 1.5 | 2.1 | 2.1 | V | V _{OUT} = 0.1 V or V _{CC} - 0.1 V | |
| | | 4.5 | 2.25 | 3.15 | 3.15 | | | |
| | | 5.5 | 2.75 | 3.85 | 3.85 | | | |
| V _{IL} | Maximum Low Level Input Voltage | 3.0 | 1.5 | 0.9 | 0.9 | V | V _{OUT} = 0.1 V or V _{CC} - 0.1 V | |
| | | 4.5 | 2.25 | 1.35 | 1.35 | | | |
| | | 5.5 | 2.75 | 1.65 | 1.65 | | | |
| V _{OH} | Minimum High Level Output Voltage | 3.0 | 2.99 | 2.9 | 2.9 | V | I _{OUT} = -50 μA | |
| | | 4.5 | 4.49 | 4.4 | 4.4 | | | |
| | | 5.5 | 5.49 | 5.4 | 5.4 | | | |
| | | 3.0 | | 2.56 | 2.46 | V | *V _{IN} = V _{IL} or V _{IH} -12 mA I _{OH} -24 mA -24 mA | |
| | | 4.5 | | 3.86 | 3.76 | | | |
| | | 5.5 | | 4.86 | 4.76 | | | |
| V _{OL} | Maximum Low Level Output Voltage | 3.0 | 0.002 | 0.1 | 0.1 | V | I _{OUT} = 50 μA | |
| | | 4.5 | 0.001 | 0.1 | 0.1 | | | |
| | | 5.5 | 0.001 | 0.1 | 0.1 | | | |
| | | 3.0 | | 0.36 | 0.44 | V | *V _{IN} = V _{IL} or V _{IH} 12 mA I _{OL} 24 mA 24 mA | |
| | | 4.5 | | 0.36 | 0.44 | | | |
| | | 5.5 | | 0.36 | 0.44 | | | |
| I _{IN} | Maximum Input Leakage Current | 5.5 | | ±0.1 | ±1.0 | μA | V _I = V _{CC} , GND | |
| I _{OLD} | †Minimum Dynamic Output Current | 5.5 | | | 75 | mA | V _{OLD} = 1.65 V Max | |
| I _{OHD} | | 5.5 | | | -75 | mA | V _{OHD} = 3.85 V Min | |
| I _{CC} | Maximum Quiescent Supply Current | 5.5 | | 8.0 | 80 | μA | V _{IN} = V _{CC} or GND | |

* All outputs loaded; thresholds on input associated with output under test.

† Maximum test duration 2.0 ms, one output loaded at a time.

Note: I_{IN} and I_{CC} @ 3.0 V are guaranteed to be less than or equal to the respective limit @ 5.5 V V_{CC}.

MC74AC352 MC74ACT352

AC CHARACTERISTICS (For Figures and Waveforms — See Section 3)

| Symbol | Parameter | V _{CC} * (V) | 74AC | | | 74AC | | Unit | Fig. No. |
|------------------|---|-----------------------|--|------------|--------------|--|--------------|------|----------|
| | | | T _A = +25°C C _L = 50 pF | | | T _A = -40°C to +85°C C _L = 50 pF | | | |
| | | | Min | Typ | Max | Min | Max | | |
| t _{PLH} | Propagation Delay S _n to Z _n | 3.3 5.0 | 2.0 2.0 | 8.5 6.5 | 15.0 11.0 | 1.0 1.0 | 17.5 12.5 | ns | 3-6 |
| t _{PHL} | Propagation Delay S _n to Z _n | 3.3 5.0 | 2.0 2.0 | 8.0 6.0 | 14.5 11.0 | 1.0 1.0 | 16.5 12.0 | ns | 3-6 |
| t _{PLH} | Propagation Delay E _n to Z _n | 3.3 5.0 | 2.0 2.0 | 6.0 4.5 | 13.5 9.5 | 1.0 1.0 | 16.0 11.0 | ns | 3-6 |
| t _{PHL} | Propagation Delay E _n to Z _n | 3.3 5.0 | 2.0 2.0 | 5.5 4.0 | 11.0 8.0 | 1.0 1.0 | 12.5 9.0 | ns | 3-6 |
| t _{PLH} | Propagation Delay I _n to Z _n | 3.3 5.0 | 2.0 2.0 | 7.0 5.0 | 12.5 9.0 | 1.0 1.0 | 14.5 10.5 | ns | 3-5 |
| t _{PHL} | Propagation Delay I _n to Z _n | 3.3 5.0 | 2.0 2.0 | 7.0 5.0 | 11.5 8.5 | 1.0 1.0 | 13.0 10.0 | ns | 3-5 |

* Voltage Range 3.3 V is 3.3 V ± 0.3 V.
Voltage Range 5.0 V is 5.0 V ± 0.5 V.

DC CHARACTERISTICS

| Symbol | Parameter | V _{CC} (V) | 74ACT | | 74ACT | | Unit | Conditions |
|--------------------|--|---------------------|------------------------|-------------------|---------------------------------|----|---|------------|
| | | | T _A = +25°C | | T _A = -40°C to +85°C | | | |
| | | | Typ | Guaranteed Limits | | | | |
| V _{IH} | Minimum High Level Input Voltage | 4.5 | 1.5 | 2.0 | 2.0 | V | V _{OUT} = 0.1 V or V _{CC} - 0.1 V | |
| | | 5.5 | 1.5 | 2.0 | 2.0 | | | |
| V _{IL} | Maximum Low Level Input Voltage | 4.5 | 1.5 | 0.8 | 0.8 | V | V _{OUT} = 0.1 V or V _{CC} - 0.1 V | |
| | | 5.5 | 1.5 | 0.8 | 0.8 | | | |
| V _{OH} | Minimum High Level Output Voltage | 4.5 | 4.49 | 4.4 | 4.4 | V | I _{OUT} = -50 μA | |
| | | 5.5 | 5.49 | 5.4 | 5.4 | | | |
| | | 4.5 | | 3.86 | 3.76 | V | *V _{IN} = V _{IL} or V _{IH} -24 mA | |
| | | 5.5 | | 4.86 | 4.76 | | | |
| V _{OL} | Maximum Low Level Output Voltage | 4.5 | 0.001 | 0.1 | 0.1 | V | I _{OUT} = 50 μA | |
| | | 5.5 | 0.001 | 0.1 | 0.1 | | | |
| | | 4.5 | | 0.36 | 0.44 | V | *V _{IN} = V _{IL} or V _{IH} 24 mA | |
| | | 5.5 | | 0.36 | 0.44 | | | |
| I _{IN} | Maximum Input Leakage Current | 5.5 | | ±0.1 | ±1.0 | μA | V _I = V _{CC} , GND | |
| ΔI _{CC} T | Additional Max. I _{CC} /Input | 5.5 | 0.6 | | 1.5 | mA | V _I = V _{CC} - 2.1 V | |
| I _{OLD} | †Minimum Dynamic Output Current | 5.5 | | | 75 | mA | V _{OLD} = 1.65 V Max | |
| I _{OHD} | | 5.5 | | | -75 | mA | V _{OHD} = 3.85 V Min | |
| I _{CC} | Maximum Quiescent Supply Current | 5.5 | | 8.0 | 80 | μA | V _{IN} = V _{CC} or GND | |

* All outputs loaded; thresholds on input associated with output under test.

† Maximum test duration 2.0 ms, one output loaded at a time.

MC74AC352 MC74ACT352

AC CHARACTERISTICS (For Figures and Waveforms — See Section 3)

| Symbol | Parameter | V _{CC} * (V) | 74ACT | | | 74ACT | | Unit | Fig. No. |
|------------------|---|-----------------------|--|-----|------|--|------|------|----------|
| | | | T _A = +25°C C _L = 50 pF | | | T _A = -40°C to +85°C C _L = 50 pF | | | |
| | | | Min | Typ | Max | Min | Max | | |
| t _{PLH} | Propagation Delay S _n to Z _n | 5.0 | 3.0 | 6.0 | 10.5 | 1.0 | 11.5 | ns | 3-6 |
| t _{PHL} | Propagation Delay S _n to Z _n | 5.0 | 3.0 | 6.0 | 10.0 | 1.0 | 11.5 | ns | 3-6 |
| t _{PLH} | Propagation Delay E _n to Z _n | 5.0 | 2.0 | 4.5 | 8.0 | 1.0 | 8.5 | ns | 3-6 |
| t _{PHL} | Propagation Delay E _n to Z _n | 5.0 | 2.0 | 4.5 | 8.0 | 1.0 | 8.5 | ns | 3-6 |
| t _{PLH} | Propagation Delay I _n to Z _n | 5.0 | 2.0 | 5.5 | 10.0 | 1.0 | 11.0 | ns | 3-5 |
| t _{PHL} | Propagation Delay I _n to Z _n | 5.0 | 2.0 | 6.5 | 8.5 | 1.0 | 9.0 | ns | 3-5 |

* Voltage Range 5.0 V is 5.0 V ±0.5 V.

CAPACITANCE

| Symbol | Parameter | Value Typ | Unit | Test Conditions |
|-----------------|-------------------------------|--------------|------|-------------------------|
| C _{IN} | Input Capacitance | 4.5 | pF | V _{CC} = 5.0 V |
| C _{PD} | Power Dissipation Capacitance | 50 | pF | V _{CC} = 5.0 V |

MC74AC352 MC74ACT352

OUTLINE DIMENSIONS

N SUFFIX PLASTIC DIP PACKAGE CASE 648-08 ISSUE R

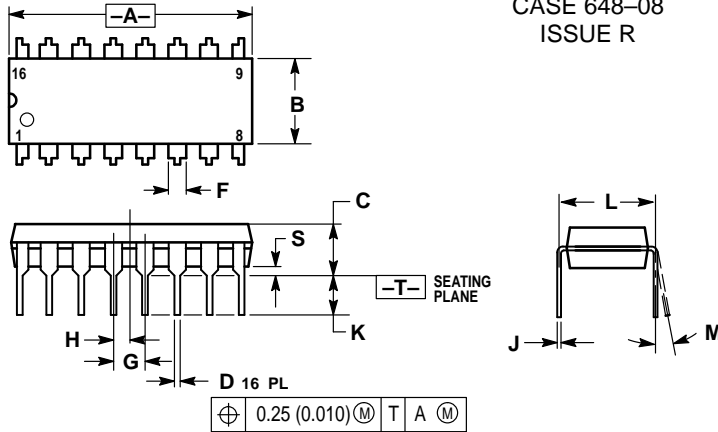

NOTES:

1. DIMENSIONING AND TOLERANCING PER ANSI Y14.5M, 1982.
2. CONTROLLING DIMENSION: INCH.
3. DIMENSION L TO CENTER OF LEADS WHEN FORMED PARALLEL.
4. DIMENSION B DOES NOT INCLUDE MOLD FLASH.
5. ROUNDED CORNERS OPTIONAL.

| DIM | INCHES | | MILLIMETERS | |
|-----|-----------|-------|-------------|-------|
| | MIN | MAX | MIN | MAX |
| A | 0.740 | 0.770 | 18.80 | 19.55 |
| B | 0.250 | 0.270 | 6.35 | 6.85 |
| C | 0.145 | 0.175 | 3.69 | 4.44 |
| D | 0.015 | 0.021 | 0.39 | 0.53 |
| F | 0.040 | 0.70 | 1.02 | 1.77 |
| G | 0.100 BSC | | 2.54 BSC | |
| H | 0.050 BSC | | 1.27 BSC | |
| J | 0.008 | 0.015 | 0.21 | 0.38 |
| K | 0.110 | 0.130 | 2.80 | 3.30 |
| L | 0.295 | 0.305 | 7.50 | 7.74 |
| M | 0° | 10° | 0° | 10° |
| S | 0.020 | 0.040 | 0.51 | 1.01 |

D SUFFIX PLASTIC SOIC PACKAGE CASE 751B-05 ISSUE J

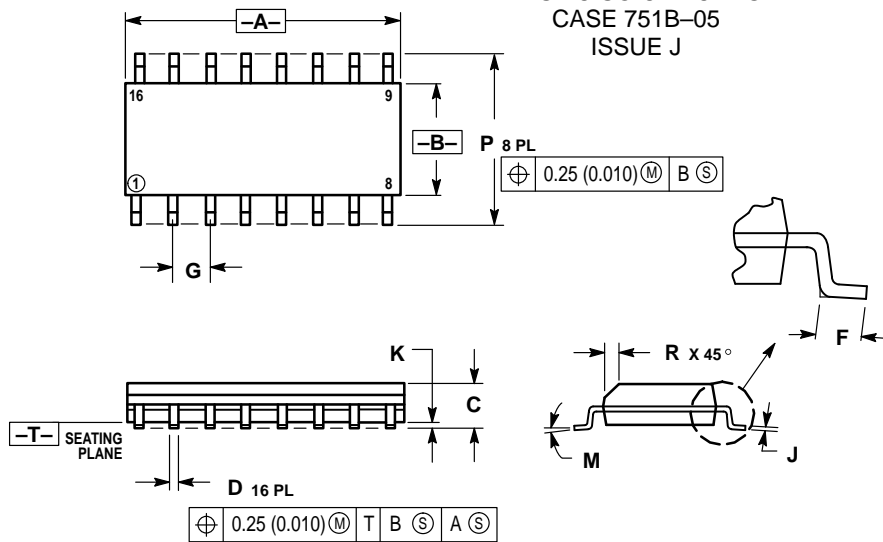

NOTES:

1. DIMENSIONING AND TOLERANCING PER ANSI Y14.5M, 1982.
2. CONTROLLING DIMENSION: MILLIMETER.
3. DIMENSIONS A AND B DO NOT INCLUDE MOLD PROTRUSION.
4. MAXIMUM MOLD PROTRUSION 0.15 (0.006) PER SIDE.
5. DIMENSION D DOES NOT INCLUDE DAMBAR PROTRUSION. ALLOWABLE DAMBAR PROTRUSION SHALL BE 0.127 (0.005) TOTAL IN EXCESS OF THE D DIMENSION AT MAXIMUM MATERIAL CONDITION.

| DIM | MILLIMETERS | | INCHES | |
|-----|-------------|-------|-----------|-------|
| | MIN | MAX | MIN | MAX |
| A | 9.80 | 10.00 | 0.386 | 0.393 |
| B | 3.80 | 4.00 | 0.150 | 0.157 |
| C | 1.35 | 1.75 | 0.054 | 0.068 |
| D | 0.35 | 0.49 | 0.014 | 0.019 |
| F | 0.40 | 1.25 | 0.016 | 0.049 |
| G | 1.27 BSC | | 0.050 BSC | |
| J | 0.19 | 0.25 | 0.008 | 0.009 |
| K | 0.10 | 0.25 | 0.004 | 0.009 |
| M | 0° | 7° | 0° | 7° |
| P | 5.80 | 6.20 | 0.229 | 0.244 |
| R | 0.25 | 0.50 | 0.010 | 0.019 |

Motorola reserves the right to make changes without further notice to any products herein. Motorola makes no warranty, representation or guarantee regarding the suitability of its products for any particular purpose, nor does Motorola assume any liability arising out of the application or use of any product or circuit, and specifically disclaims any and all liability, including without limitation consequential or incidental damages. "Typical" parameters can and do vary in different applications. All operating parameters, including "Typicals" must be validated for each customer application by customer's technical experts. Motorola does not convey any license under its patent rights nor the rights of others. Motorola products are not designed, intended, or authorized for use as components in systems intended for surgical implant into the body, or other applications intended to support or sustain life, or for any other application in which the failure of the Motorola product could create a situation where personal injury or death may occur. Should Buyer purchase or use Motorola products for any such unintended or unauthorized application, Buyer shall indemnify and hold Motorola and its officers, employees, subsidiaries, affiliates, and distributors harmless against all claims, costs, damages, and expenses, and reasonable attorney fees arising out of, directly or indirectly, any claim of personal injury or death associated with such unintended or unauthorized use, even if such claim alleges that Motorola was negligent regarding the design or manufacture of the part. Motorola and  are registered trademarks of Motorola, Inc. Motorola, Inc. is an Equal Opportunity/Affirmative Action Employer.

How to reach us:

USA/EUROPE: Motorola Literature Distribution;
P.O. Box 20912; Phoenix, Arizona 85036. 1-800-441-2447

JAPAN: Nippon Motorola Ltd.; Tatsumi-SPD-JLDC, Toshikatsu Otsuki,
6F Seibu-Butsuryu-Center, 3-14-2 Tatsumi Koto-Ku, Tokyo 135, Japan. 03-3521-8315

MFAX: RMFA00@email.sps.mot.com -TOUCHTONE (602) 244-6609
INTERNET: <http://Design-NET.com>

HONG KONG: Motorola Semiconductors H.K. Ltd.; 8B Tai Ping Industrial Park,
51 Ting Kok Road, Tai Po, N.T., Hong Kong. 852-26629298



MC74AC352/D

