

TOSHIBA BIPOLAR LINEAR INTEGRATED CIRCUIT SILICON MONOLITHIC

**TA48M025F, TA48M03F, TA48M033F  
TA48M0345F, TA48M04F, TA48M05F**

**2.5 V, 3 V, 3.3 V, 3.45 V, 4 V, 5V**

**THREE TERMINAL LOW DROPOUT VOLTAGE REGULATOR**

The TA48M\*\*F series consists of fixed-positive-output, low-dropout regulators with an output current of 500 mA (max.). In response to the need for low-voltage devices, the series offers devices with low output voltages : 2.5 V, 3 V, 3.3 V, 3.45 V, 4 V which are not included in the existing TA78DM\*\*S series (0.5 A low dropout).

**FEATURES**

- Output current in excess of 0.5 A
- Low standby current : 0.8 mA (typ.)
- Low-dropout voltage : 0.65 V (max.) @ $I_O = 0.5 A$
- Protection function : overheat / overcurrent / overvoltage / reversed power supply connections
- Power mold package : Surface-mount type for reflow soldering is also supported

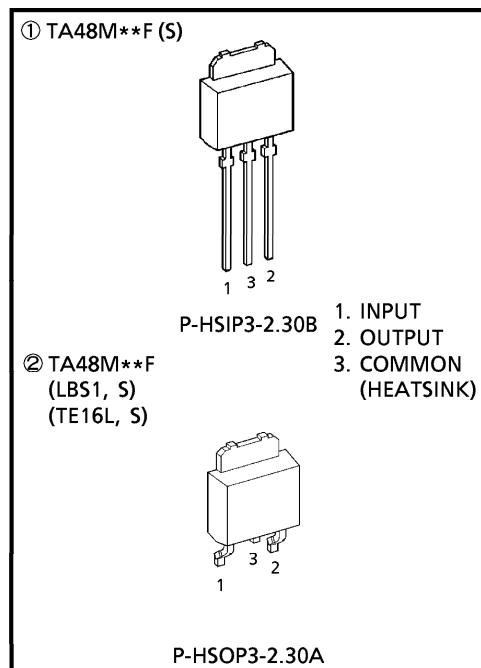

Weight  
P-HSIP3-2.30B : 0.36 g (Typ.)  
P-HSOP3-2.30A : 0.36 g (Typ.)

**ORDERING METHOD**

	PRODUCT NAME	PACKAGE (LEAD TYPE)	PACKING FORM
①	TA48M**F (S)	PW-MOLD : Straight lead	Sack (200 pcs. / sack)
②	TA48M**F (LBS1, S)	PW-MOLD : Surface-mount	Stick (100 pcs. max)
	TA48M**F (TE16L, S)	PW-MOLD : Surface-mount	Tape (700 pcs. / reel)

(Note) : The “\*\*” in each proforma product name is replaced with the output voltage of each product.

Example : For 3 V. TA48M03F

980910EBA1

- TOSHIBA is continually working to improve the quality and the reliability of its products. Nevertheless, semiconductor devices in general can malfunction or fail due to their inherent electrical sensitivity and vulnerability to physical stress. It is the responsibility of the buyer, when utilizing TOSHIBA products, to observe standards of safety, and to avoid situations in which a malfunction or failure of a TOSHIBA product could cause loss of human life, bodily injury or damage to property. In developing your designs, please ensure that TOSHIBA products are used within specified operating ranges as set forth in the most recent products specifications. Also, please keep in mind the precautions and conditions set forth in the TOSHIBA Semiconductor Reliability Handbook.
- The products described in this document are subject to the foreign exchange and foreign trade laws.
- The information contained herein is presented only as a guide for the applications of our products. No responsibility is assumed by TOSHIBA CORPORATION for any infringements of intellectual property or other rights of the third parties which may result from its use. No license is granted by implication or otherwise under any intellectual property or other rights of TOSHIBA CORPORATION or others.
- The information contained herein is subject to change without notice.

**BLOCK DIAGRAM**

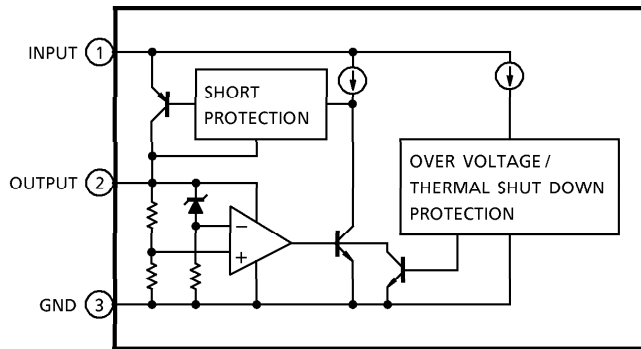

**MAXIMUM RATINGS (Ta = 25°C)**

CHARACTERISTIC	SYMBOL	RATING	UNIT
Input Voltage	V <sub>IN</sub>	29	V
Output Current	I <sub>OUT</sub>	0.5	A
Power Dissipation	P <sub>D</sub>	(Ta = 25°C)	1
		(Tc = 25°C)	10
Operating Temperature	T <sub>opr</sub>	- 40~85	°C
Storage Temperature	T <sub>stg</sub>	- 55~150	°C
Junction Temperature	T <sub>j</sub>	150	°C
Thermal Resistance	Rth (j-c)	12.5	°C / W
	Rth (j-a)	125	

**PROTECTION FUNCTION**

CHARACTERISTIC	SYMBOL	MIN.	TYP.	MAX.	UNIT
Overvoltage	V <sub>IN</sub>	29	33	—	V
Overheat	T <sub>j</sub>	—	175	—	°C

## TA48M025F

**ELECTRICAL CHARACTERISTICS**(V<sub>IN</sub> = 4.5 V, I<sub>OUT</sub> = 250 mA, T<sub>j</sub> = 25°C, C<sub>IN</sub> = 0.1 μF, C<sub>OUT</sub> = 10 μF, unless otherwise specified)

CHARACTERISTIC	SYMBOL	TEST CONDITION	MIN.	TYP.	MAX.	UNIT
Output Voltage	V <sub>OUT</sub>	—	2.4	2.5	2.6	V
		3.5 V ≤ V <sub>IN</sub> ≤ 16 V, 5 mA ≤ I <sub>OUT</sub> ≤ 500 mA, 0°C ≤ T <sub>j</sub> ≤ 125°C	2.375	2.5	2.625	
Line Regulation	Reg·line	3.5 V ≤ V <sub>IN</sub> ≤ 16 V	—	7	18	mV
Load Regulation	Reg·load	5 mA ≤ I <sub>OUT</sub> ≤ 500 mA	—	45	90	mV
Quiescent Current	I <sub>B</sub>	3.5 V ≤ V <sub>IN</sub> ≤ 16 V, I <sub>OUT</sub> = 0 mA	—	0.8	1.4	mA
		3.5 V ≤ V <sub>IN</sub> ≤ 16 V, I <sub>OUT</sub> = 250 mA	—	12	25	
Output Noise Voltage	V <sub>NO</sub>	10 Hz ≤ f ≤ 100 kHz, I <sub>OUT</sub> = 50 mA	—	72	—	μV <sub>rms</sub>
Ripple Rejection	R.R.	f = 120 Hz, 3.5 V ≤ V <sub>IN</sub> ≤ 16 V, I <sub>OUT</sub> = 50 mA	62	72	—	dB
Dropout Voltage	V <sub>D</sub>	I <sub>OUT</sub> = 250 mA	—	0.17	0.35	V
		I <sub>OUT</sub> = 500 mA	—	0.35	0.65	
Peak Circuit Current	I <sub>PEAK</sub>	—	0.60	1.15	1.40	A
Short Circuit Current	ISC	—	0.60	1.15	1.40	A

## TA48M03F

**ELECTRICAL CHARACTERISTICS**(V<sub>IN</sub> = 5 V, I<sub>OUT</sub> = 250 mA, T<sub>j</sub> = 25°C, C<sub>IN</sub> = 0.1 μF, C<sub>OUT</sub> = 10 μF, unless otherwise specified)

CHARACTERISTIC	SYMBOL	TEST CONDITION	MIN.	TYP.	MAX.	UNIT
Output Voltage	V <sub>OUT</sub>	—	2.88	3.0	3.12	V
		4 V ≤ V <sub>IN</sub> ≤ 16 V, 5 mA ≤ I <sub>OUT</sub> ≤ 500 mA, 0°C ≤ T <sub>j</sub> ≤ 125°C	2.85	3.0	3.15	
Line Regulation	Reg·line	4 V ≤ V <sub>IN</sub> ≤ 16 V	—	8	21	mV
Load Regulation	Reg·load	5 mA ≤ I <sub>OUT</sub> ≤ 500 mA	—	45	95	mV
Quiescent Current	I <sub>B</sub>	4 V ≤ V <sub>IN</sub> ≤ 16 V, I <sub>OUT</sub> = 0 mA	—	0.8	1.4	mA
		4 V ≤ V <sub>IN</sub> ≤ 16 V, I <sub>OUT</sub> = 250 mA	—	12	25	
Output Noise Voltage	V <sub>NO</sub>	10 Hz ≤ f ≤ 100 kHz, I <sub>OUT</sub> = 50 mA	—	90	—	μV <sub>rms</sub>
Ripple Rejection	R.R.	f = 120 Hz, 4 V ≤ V <sub>IN</sub> ≤ 16 V, I <sub>OUT</sub> = 50 mA	60	70	—	dB
Dropout Voltage	V <sub>D</sub>	I <sub>OUT</sub> = 250 mA	—	0.17	0.35	V
		I <sub>OUT</sub> = 500 mA	—	0.35	0.65	
Peak Circuit Current	I <sub>PEAK</sub>	—	0.60	1.20	1.45	A
Short Circuit Current	ISC	—	0.60	1.20	1.45	A

## TA48M033F

**ELECTRICAL CHARACTERISTICS**(V<sub>IN</sub> = 5.3 V, I<sub>OUT</sub> = 250 mA, T<sub>j</sub> = 25°C, C<sub>IN</sub> = 0.1 μF, C<sub>OUT</sub> = 10 μF, unless otherwise specified)

CHARACTERISTIC	SYMBOL	TEST CONDITION	MIN.	TYP.	MAX.	UNIT
Output Voltage	V <sub>OUT</sub>	—	3.168	3.3	3.432	V
		4.3 V ≤ V <sub>IN</sub> ≤ 16 V, 5 mA ≤ I <sub>OUT</sub> ≤ 500 mA, 0°C ≤ T <sub>j</sub> ≤ 125°C	3.135	3.3	3.465	
Line Regulation	Reg-line	4.3 V ≤ V <sub>IN</sub> ≤ 16 V	—	10	23	mV
Load Regulation	Reg-load	5 mA ≤ I <sub>OUT</sub> ≤ 500 mA	—	45	105	mV
Quiescent Current	I <sub>B</sub>	4.3 V ≤ V <sub>IN</sub> ≤ 16 V, I <sub>OUT</sub> = 0 mA	—	0.8	1.4	mA
		4.3 V ≤ V <sub>IN</sub> ≤ 16 V, I <sub>OUT</sub> = 250 mA	—	12	25	
Output Noise Voltage	V <sub>NO</sub>	10 Hz ≤ f ≤ 100 kHz, I <sub>OUT</sub> = 50 mA	—	90	—	μV <sub>rms</sub>
Ripple Rejection	R.R.	f = 120 Hz, 4.3 V ≤ V <sub>IN</sub> ≤ 16 V, I <sub>OUT</sub> = 50 mA	60	70	—	dB
Dropout Voltage	V <sub>D</sub>	I <sub>OUT</sub> = 250 mA	—	0.17	0.35	V
		I <sub>OUT</sub> = 500 mA	—	0.35	0.65	
Peak Circuit Current	I <sub>PEAK</sub>	—	0.60	1.20	1.45	A
Short Circuit Current	ISC	—	0.60	1.20	1.45	A

## TA48M0345F

**ELECTRICAL CHARACTERISTICS**(V<sub>IN</sub> = 5.45 V, I<sub>OUT</sub> = 250 mA, T<sub>j</sub> = 25°C, C<sub>IN</sub> = 0.1 μF, C<sub>OUT</sub> = 10 μF, unless otherwise specified)

CHARACTERISTIC	SYMBOL	TEST CONDITION	MIN.	TYP.	MAX.	UNIT
Output Voltage	V <sub>OUT</sub>	—	3.312	3.45	3.588	V
		4.45 V ≤ V <sub>IN</sub> ≤ 16 V, 5 mA ≤ I <sub>OUT</sub> ≤ 500 mA, 0°C ≤ T <sub>j</sub> ≤ 125°C	3.278	3.45	3.622	
Line Regulation	Reg-line	4.45 V ≤ V <sub>IN</sub> ≤ 16 V	—	12	25	mV
Load Regulation	Reg-load	5 mA ≤ I <sub>OUT</sub> ≤ 500 mA	—	45	110	mV
Quiescent Current	I <sub>B</sub>	4.45 V ≤ V <sub>IN</sub> ≤ 16 V, I <sub>OUT</sub> = 0 mA	—	0.8	1.4	mA
		4.45 V ≤ V <sub>IN</sub> ≤ 16 V, I <sub>OUT</sub> = 250 mA	—	12	25	
Output Noise Voltage	V <sub>NO</sub>	10 Hz ≤ f ≤ 100 kHz, I <sub>OUT</sub> = 50 mA	—	90	—	μV <sub>rms</sub>
Ripple Rejection	R.R.	f = 120 Hz, 4.45 V ≤ V <sub>IN</sub> ≤ 16 V, I <sub>OUT</sub> = 50 mA	60	70	—	dB
Dropout Voltage	V <sub>D</sub>	I <sub>OUT</sub> = 250 mA	—	0.17	0.35	V
		I <sub>OUT</sub> = 500 mA	—	0.35	0.65	
Peak Circuit Current	I <sub>PEAK</sub>	—	0.60	1.20	1.45	A
Short Circuit Current	ISC	—	0.60	1.20	1.45	A

## TA48M04F

**ELECTRICAL CHARACTERISTICS**(V<sub>IN</sub> = 6 V, I<sub>OUT</sub> = 250 mA, T<sub>j</sub> = 25°C, C<sub>IN</sub> = 0.1 μF, C<sub>OUT</sub> = 10 μF, unless otherwise specified)

CHARACTERISTIC	SYMBOL	TEST CONDITION	MIN.	TYP.	MAX.	UNIT
Output Voltage	V <sub>OUT</sub>	—	3.84	4.0	4.16	V
		5 V ≤ V <sub>IN</sub> ≤ 16 V, 5 mA ≤ I <sub>OUT</sub> ≤ 500 mA, 0°C ≤ T <sub>j</sub> ≤ 125°C	3.8	4.0	4.2	
Line Regulation	Reg·line	5 V ≤ V <sub>IN</sub> ≤ 16 V	—	11	28	mV
Load Regulation	Reg·load	5 mA ≤ I <sub>OUT</sub> ≤ 500 mA	—	45	115	mV
Quiescent Current	I <sub>B</sub>	5 V ≤ V <sub>IN</sub> ≤ 16 V, I <sub>OUT</sub> = 0 mA	—	0.9	1.4	mA
		5 V ≤ V <sub>IN</sub> ≤ 16 V, I <sub>OUT</sub> = 250 mA	—	13	25	
Output Noise Voltage	V <sub>NO</sub>	10 Hz ≤ f ≤ 100 kHz, I <sub>OUT</sub> = 50 mA	—	110	—	μV <sub>rms</sub>
Ripple Rejection	R.R.	f = 120 Hz, 5 V ≤ V <sub>IN</sub> ≤ 16 V, I <sub>OUT</sub> = 50 mA	58	68	—	dB
Dropout Voltage	V <sub>D</sub>	I <sub>OUT</sub> = 250 mA	—	0.17	0.35	V
		I <sub>OUT</sub> = 500 mA	—	0.35	0.65	
Peak Circuit Current	I <sub>PEAK</sub>	—	0.60	1.25	1.50	A
Short Circuit Current	I <sub>SC</sub>	—	0.60	1.25	1.50	A

## TA48M05F

**ELECTRICAL CHARACTERISTICS**(V<sub>IN</sub> = 7 V, I<sub>OUT</sub> = 250 mA, T<sub>j</sub> = 25°C, C<sub>IN</sub> = 0.1 μF, C<sub>OUT</sub> = 10 μF, unless otherwise specified)

CHARACTERISTIC	SYMBOL	TEST CONDITION	MIN.	TYP.	MAX.	UNIT
Output Voltage	V <sub>OUT</sub>	—	4.8	5.0	5.2	V
		6 V ≤ V <sub>IN</sub> ≤ 18 V, 5 mA ≤ I <sub>OUT</sub> ≤ 500 mA, 0°C ≤ T <sub>j</sub> ≤ 125°C	4.75	5.0	5.25	
Line Regulation	Reg·line	6 V ≤ V <sub>IN</sub> ≤ 18 V	—	15	35	mV
Load Regulation	Reg·load	5 mA ≤ I <sub>OUT</sub> ≤ 500 mA	—	50	135	mV
Quiescent Current	I <sub>B</sub>	6 V ≤ V <sub>IN</sub> ≤ 18 V, I <sub>OUT</sub> = 0 mA	—	1.0	1.4	mA
		6 V ≤ V <sub>IN</sub> ≤ 18 V, I <sub>OUT</sub> = 250 mA	—	13	25	
Output Noise Voltage	V <sub>NO</sub>	10 Hz ≤ f ≤ 100 kHz, I <sub>OUT</sub> = 50 mA	—	125	—	μV <sub>rms</sub>
Ripple Rejection	R.R.	f = 120 Hz, 6 V ≤ V <sub>IN</sub> ≤ 18 V, I <sub>OUT</sub> = 50 mA	58	68	—	dB
Dropout Voltage	V <sub>D</sub>	I <sub>OUT</sub> = 250 mA	—	0.17	0.35	V
		I <sub>OUT</sub> = 500 mA	—	0.35	0.65	
Peak Circuit Current	I <sub>PEAK</sub>	—	0.60	1.30	1.55	A
Short Circuit Current	I <sub>SC</sub>	—	0.60	1.30	1.55	A

## STANDARD APPLICATION CIRCUITS

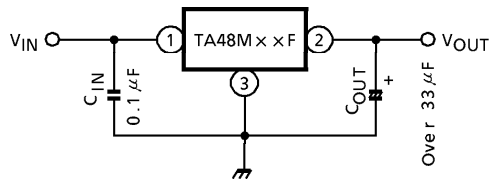

Connect the input terminal and GND, and the output terminal and GND, by capacitor respectively. The capacitances should be determined experimentally. In particular, adequate investigation should be made so that there is no problem even at time of high or low temperature.

(Note) : Depending on a using capacitor that connects to the output, characteristics (capacitance, frequency and others) may decline and the output may oscillate. To prevent this, Toshiba recommend a tantalum electrolytic capacitor that has a small fluctuation in capacitance characteristics.

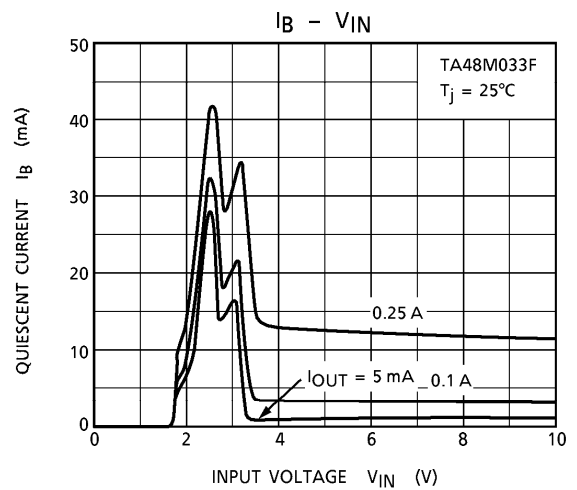
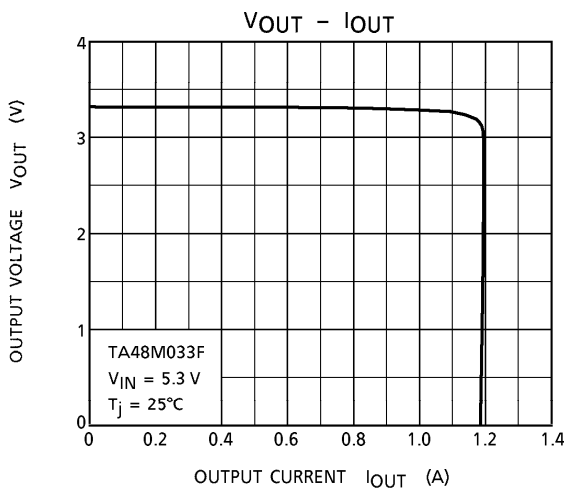
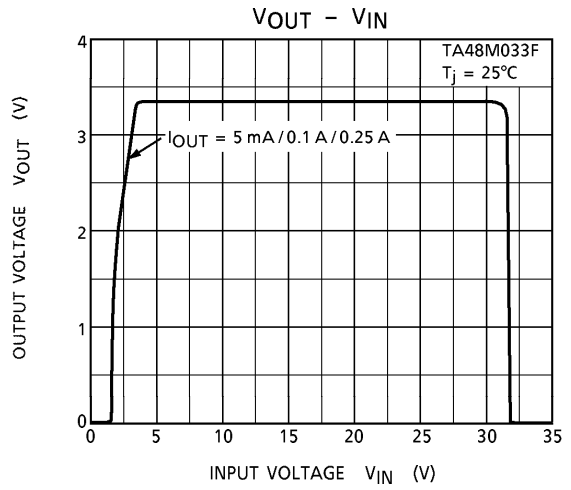
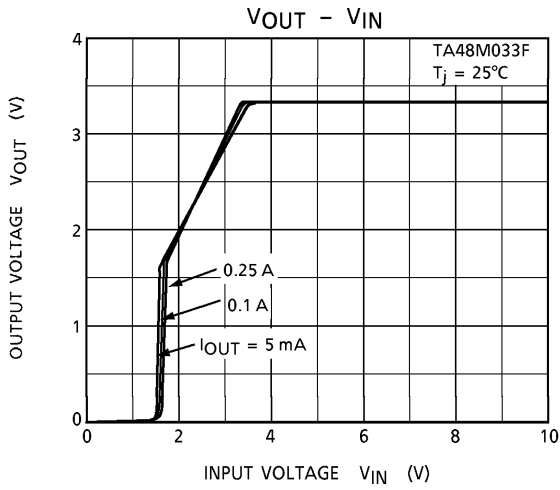
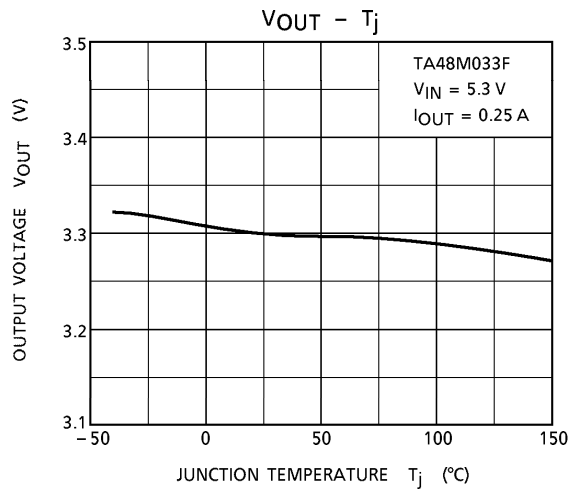
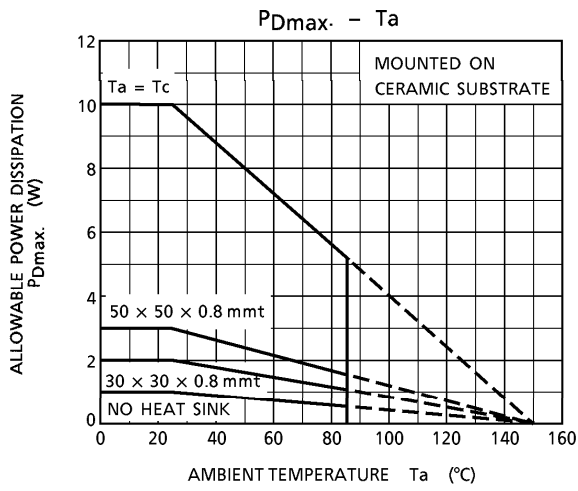

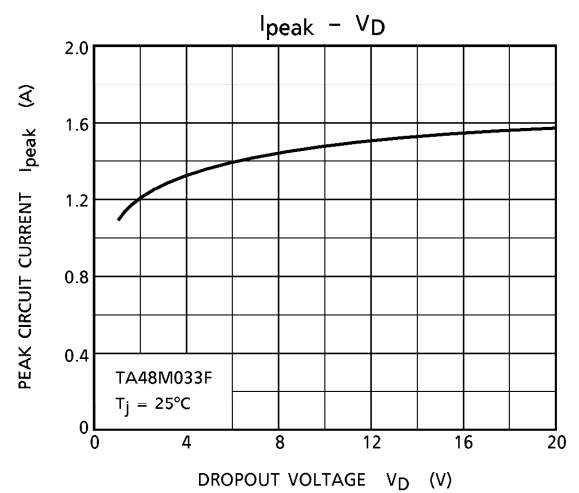
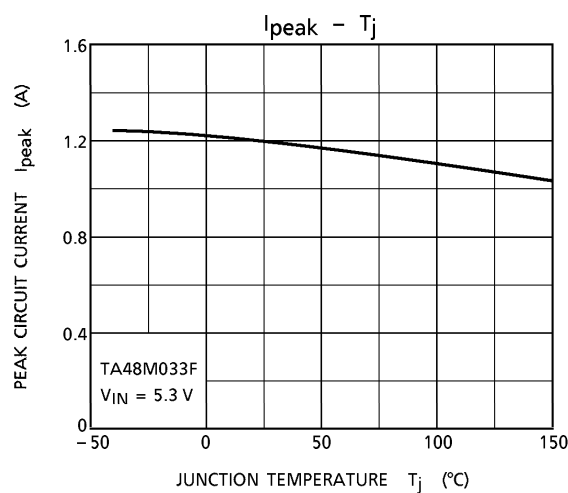
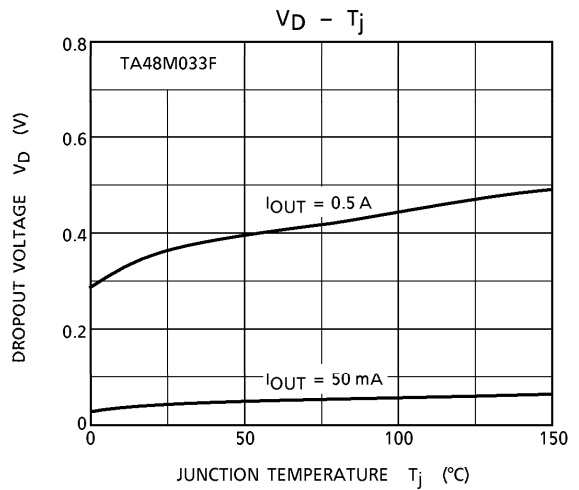
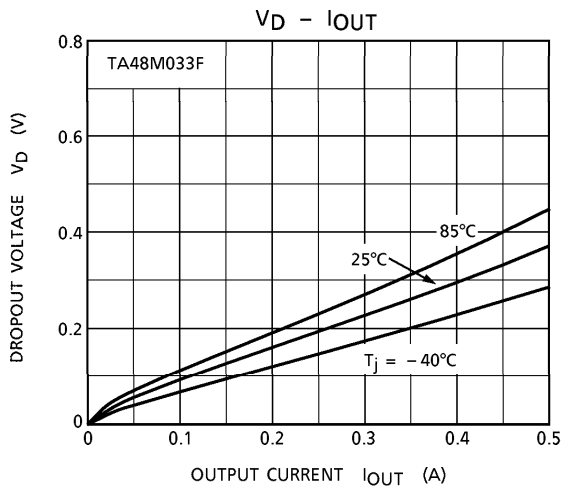
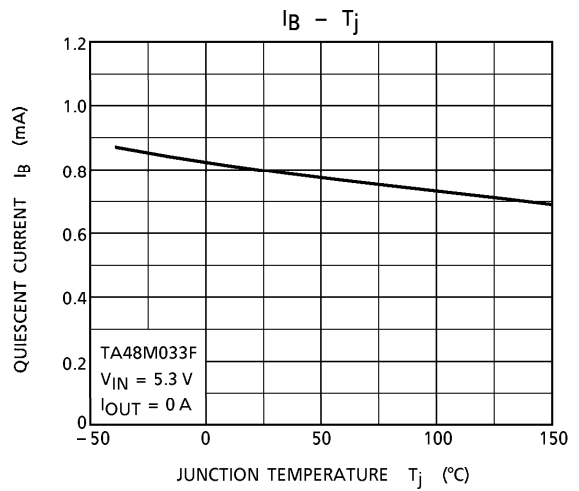
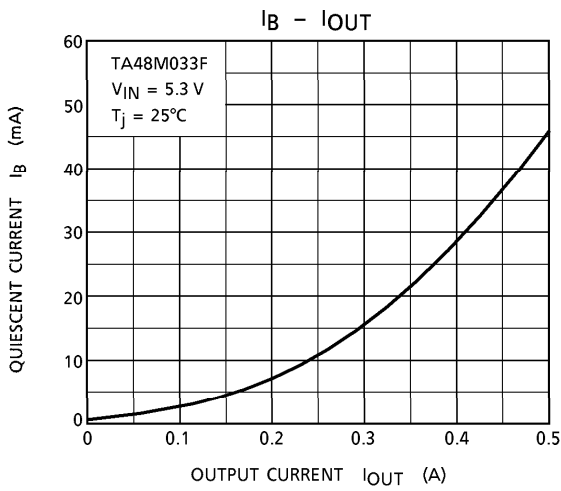



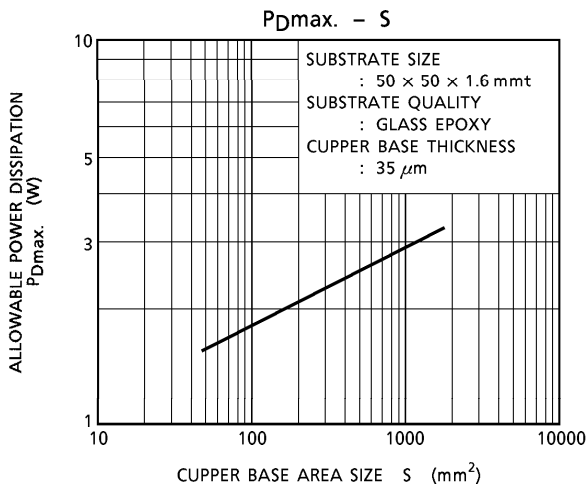
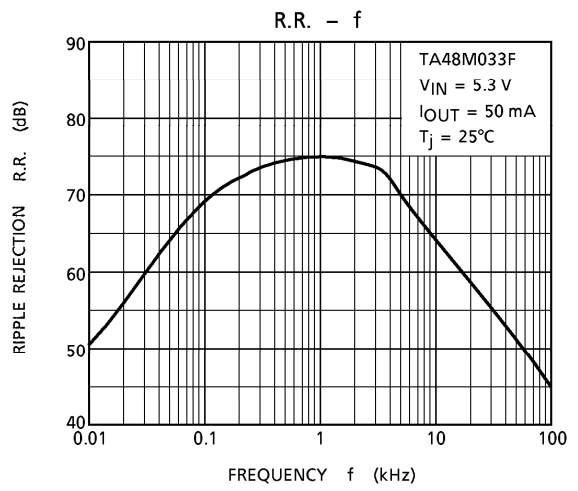
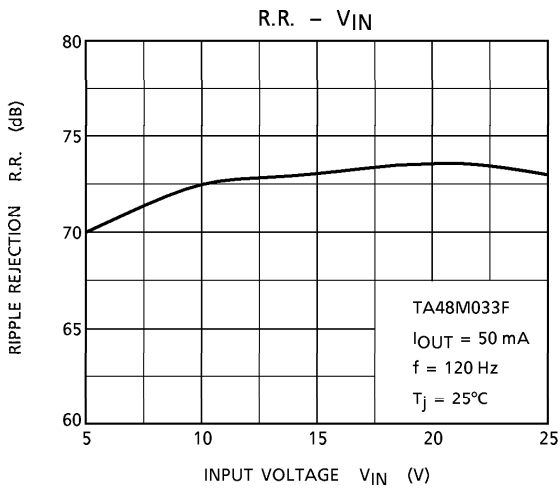

**PACKAGE DIMENSIONS**  
P-HSIP3-2.30B

Unit : mm

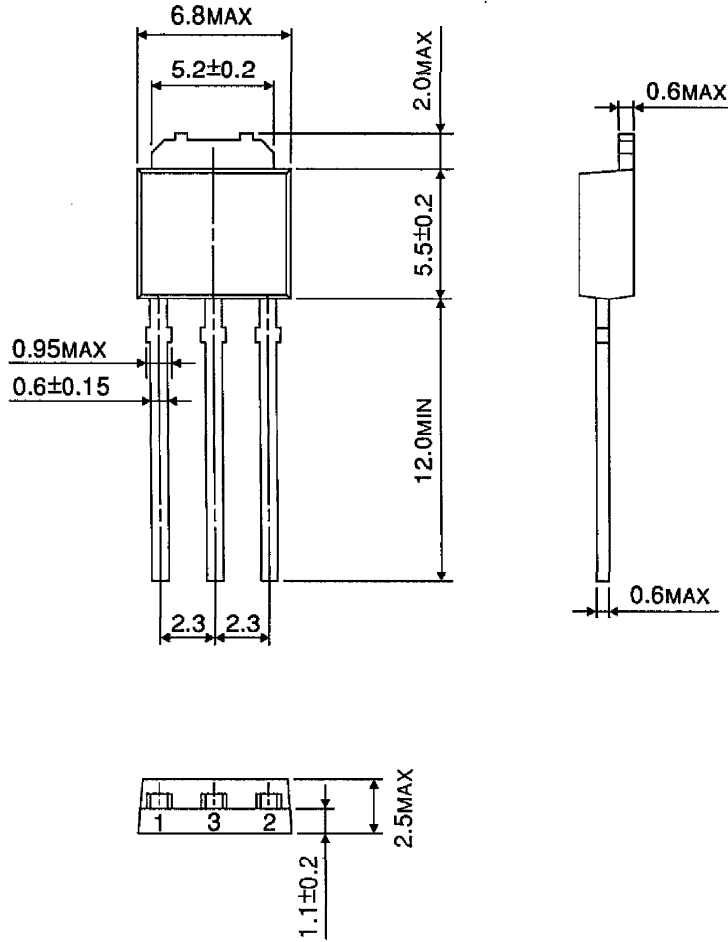

Weight : 0.36 g (Typ.)

PACKAGE DIMENSIONS  
P-HSOP3-2.30A

Unit : mm

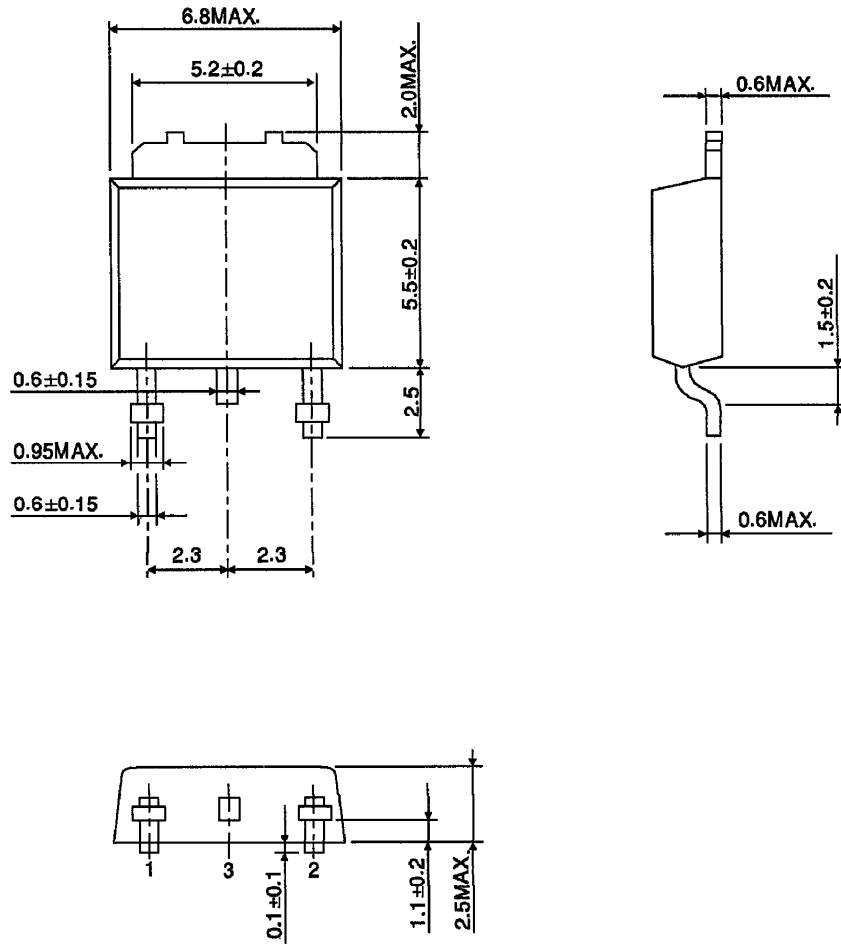

Weight : 0.36 g (Typ.)