

# Chip tantalum capacitors with open-function built-in

## TCFG series

**●Features**

- 1) Safety design by open function built - in.
- 2) Wide capacitance range
- 3) Screening by thermal shock.

**●External dimensions (Units : mm)**

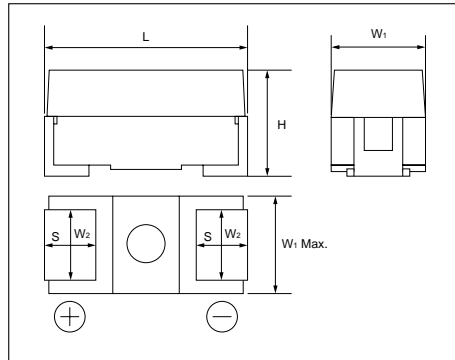

Case code	L	W <sub>1</sub>	W <sub>2</sub>	H	S
P (2012)	2.0±0.2	1.25±0.2	0.9±0.2	Max.1.20	0.45±0.3
A (3216)	3.2±0.2	1.6±0.2	1.2±0.2	1.6±0.2	0.8±0.3
B (3528)	3.5±0.2	2.8±0.2	1.9±0.2	1.9±0.2	0.8±0.3

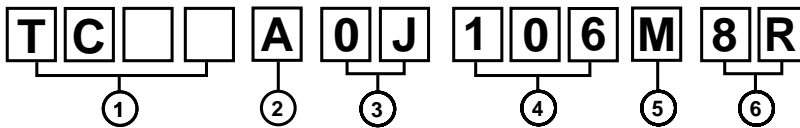

① Series name  
TC/TCFG

② Case code  
TC.....M,P,A  
TCFG..... P,A,B

③ Rated voltage

Rated voltage (V)	4	6.3	10	16	20
CODE	0G	0J	1A	1C	1D

④ Capacitance  
pF Code : 1st two digits represent significant figures, 3rd digit represent multiplier (number of zeros to follow)

⑤ Capacitance Tolerance  
M : ±20%      K : ±10%

⑥ Taping  
8 : Tape width (8mm)  
R : Anode is on the opposite side of the sprocket hole

Tantalum capacitors

●Capacitance range

TCFG series

μF	Rated voltage (V.DC)				
	4 0G	6.3 0J	10 1A	16 1C	20 1D
1.0			P	P,A	A
1.5		P	P,A	A	
2.2	P	P	P,A	A	
3.3	P	P,A	P,A	A,B	
4.7	P,A	P,A	P,A,B	A,B	
6.8	P,A	P,A	A,B	A,B	
10	P,A	P,A,B	A,B	A,B	
15	P,A,B	P,A,B	A,B	B	
22	P,A,B	A,B	A*,B	B	
33	A,B	A,B	B		
47	A,B	B	B		
68	B	B			
100	B	B			

\*Please contact us about this product.

typical example

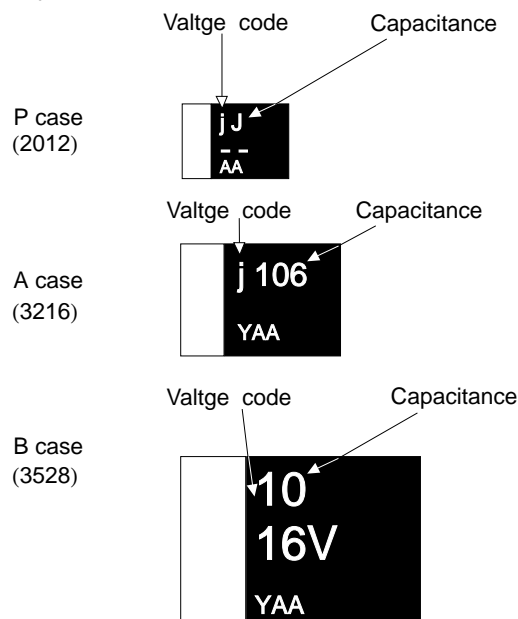

## Tantalum capacitors

## ●Characteristics

Item		Performance	Test methods / conditions (based on JIS C 5102, 5143)															
Operating temperature		-55°C ~ +125°C																
Max. operating temperature at rated voltage		+85°C																
Rated voltage (V. DC)		4   6.3   10   16   20																
Derated voltage (V. DC)		2.5   4   6.3   10   13	at 125°C															
Surge voltage (V. DC)		5.2   8   13   20   26																
Leakage current		Less than or equal to the larger of 0.5μA or 0.01CV. Details are given in Table 1, "Standard Product List".	Measured value 60s after application of rated voltage.															
Capacitance range		1.0 ~ 100μF	Measured frequency: 120 ± 12Hz Measured voltage: 0.5Vrms + 1.5V. DC Measured circuit: equivalent series circuit															
tanδ	P case	1μF to 4.7μF : 0.08 max. 6.8μF to 15μF : 0.10 max.	Measured frequency: 120 ± 12Hz Measured voltage: 0.5Vrms + 1.5V. DC Measured circuit: equivalent series circuit															
	A case	1μF max.: 0.04 max. 1.5μF to 22μF : 0.06 max. 33μF to 47μF : 0.08 max.																
	B case	3.3μF to 47μF : 0.06 max. 68μF to 100μF : 0.08 max.																
Impedance	P case	27.5Ω max.	Measured frequency: 100 ± 10Hz Measured voltage: 0.5Vrms max. Measured circuit: equivalent series circuit															
	A case	20.0Ω max.																
	B case	15.0Ω max.																
Resistance to solder heat	Appearance	No noticeable irregularities, and the markings must be easy to read.	Direct immersion into solder bath Solder bath temperature: 260 ± 5°C Immersion time: 5s Immersion cycles: 1 time															
	L.C	Must satisfy the initial specified value.																
	ΔC / C	A · B case within ± 5% P case within ± 10%																
	tanδ	P case 1.5 times or less or initial specified tolerance. A · B case must satisfy the initial specified value.																
Open function operation		320°C for 20s or less	Direct immersion into solder bath (320 ± 5°C)															
Temperature cycle	Appearance	No noticeable irregularities, and the markings must be easy to read.	The four cycles in the table below are repeated five times in succession.															
	L.C	Must satisfy the initial specified value. P case = Within 150% of initial limit.																
	ΔC / C	P case within ± 10% A · B case within ± 5%																
	tanδ	P case 1.5 times or less or initial specified tolerance. A · B case must satisfy the initial specified value.																
			<table border="1"> <thead> <tr> <th></th> <th>Temperature</th> <th>Time</th> </tr> </thead> <tbody> <tr> <td>1</td> <td>-55 ± 3°C</td> <td>30 ± 3mins.</td> </tr> <tr> <td>2</td> <td>Room temperature</td> <td>3mins. max.</td> </tr> <tr> <td>3</td> <td>125 ± 2°C</td> <td>30 ± 3mins.</td> </tr> <tr> <td>4</td> <td>Room temperature</td> <td>3mins. max.</td> </tr> </tbody> </table>		Temperature	Time	1	-55 ± 3°C	30 ± 3mins.	2	Room temperature	3mins. max.	3	125 ± 2°C	30 ± 3mins.	4	Room temperature	3mins. max.
	Temperature	Time																
1	-55 ± 3°C	30 ± 3mins.																
2	Room temperature	3mins. max.																
3	125 ± 2°C	30 ± 3mins.																
4	Room temperature	3mins. max.																
Resistance to humidity (steady state)	Appearance	No noticeable irregularities, and the markings must be easy to read.	Measured after being left for 500 ± 12hrs. at 60 ± 2°C and 90 to 95% RH, then 1 to 2 hrs. at normal room temperature and humidity.															
	L.C	Must satisfy the initial specified value.																
	ΔC / C	P case within ± 20% A · B case within ± 10%																
	tanδ	P case 1.5 times or less or initial specified tolerance. A · B case must satisfy the initial specified value.																

## Tantalum capacitors

Item		Performance	Test methods / conditions (based on JIS C 5102,5143)
Temperature characteristics	Temperature	-55°C	
	$\Delta C / C$	P case within +0% and -15% of the value before testing. A · B case within +10% and -0% of the value before testing.	
	$\tan\delta$	P case within 1.5 times of the value before testing. A · B case must satisfy the initial specified value.	
	L.C	-	
	Temperature	+85°C	
	$\Delta C / C$	P case within +0% and -15% of the value before testing. A · B case within +0% and -10% of the value before testing.	
	$\tan\delta$	Must satisfy the initial specified value.	
	L.C	Less than or equal to the larger of 5 $\mu$ A or 0.1CV.	
	Temperature	+125°C	
	$\Delta C / C$	P case within +20% and -0% of the value before testing. A · B case within +15% and -0% of the value before testing.	
$\tan\delta$	P case within 1.5 times of the value before testing. A · B case must satisfy the initial specified value.		
L.C	Less than or equal to the larger of 6.3 $\mu$ A or 0.125CV.		
Surge resistance	Appearance	A · B case no noticeable irregularities, and the markings must be easy to read.	Apply the rated surge voltage for 30 $\pm$ 5s at intervals of 5 $\pm$ .05mins. 1000 times, with the temperature at 85 $\pm$ 2°C.
	L.C	Must satisfy the initial specified value.	
	$\Delta C / C$	P case within $\pm$ 10% A · B case within $\pm$ 5%	
	$\tan\delta$	P case within 1.5 times of the value before testing. A · B case must satisfy the initial specified value.	
High-temperature load	Appearance	No noticeable irregularities, and the markings must be easy to read.	Temp. : 85 $\pm$ 2°C Series Resistance : 3 $\Omega$ max. Applied voltage : rated voltage Test time : P case 1000 $\pm$ <sup>+36</sup> <sub>0</sub> hrs A · B case 2000 $\pm$ <sup>+73</sup> <sub>0</sub> hrs measure made after pieces shall be left for 1 to 2 hrs under room temp. and room humidity after test.
	L. C	Must satisfy the initial specified value.	
	$\Delta C / C$	Within $\pm$ 10%	
	$\tan\delta$	P case within 1.5 times of the value before testing. A · B case must satisfy the initial specified value.	
Terminal strength	Capacitance	Value must be stable during measurement.	Apply pressure to the device using the specified tool for 5s so that the center deflection is 1mm (see below).
	Appearance	No noticeable irregularities.	

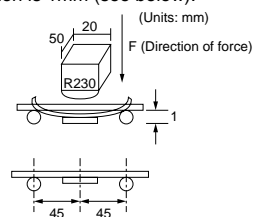

## Tantalum capacitors

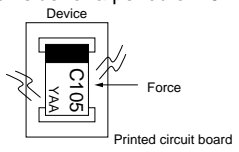
Item		Performance	Test conditions
Adhesion		Terminals must not detach.	<p>With the device mounted on the printed circuit board, apply a force of <math>0.5\text{kg} \cdot f</math> from each side for a period of <math>10 \pm 1\text{s}</math>.</p> 
External dimensions		Refer to "External dimensions"	Measure using slide calipers that meet the requirements of JIS B7507 Class 2.
Markings	Resistance to solvents	Marking must be easy to read.	Immerse in isopropyl alcohol for $30 \pm 5\text{s}$ .
Solderability Inspect the solder cover of the terminals using a solder immersion test		At least 3 / 4 of the surface of the immersed terminals must be covered with new solder.	<p>Immersion speed: <math>25 \pm 2.5\text{mm} / \text{s}</math>  Pre-processing (accelerated aging): leave for 1hr over boiling distilled water.  Solder temperature: <math>235 \pm 5^\circ\text{C}</math>  Immersion time: <math>2 \pm 0.5\text{s}</math>  Solder type: H63A  Flux: rosin 25%, IPA 75%</p>
Resistance to vibration	Capacitance	Value must be stable during measurement.	Vibrate in the X / Y axis at frequencies of 10~55~10Hz / minute for two hours each, with a total vibration amplitude of 1.5mm.
	Appearance	No noticeable irregularities.	
Reverse polarity withstanding voltage	Appearance	No noticeable irregularities, and the markings must be easy to read.	Apply either 0.1 times the rated voltage, or 3V, whichever is smaller, via a series resistor of $3\Omega_{\text{max}}$ and $0.1\Omega_{\text{min}}$ at a temperature of $85 \pm 2^\circ\text{C}$ .
	L.C	Must be less than or equal to twice the initial specified value.	
	$\Delta C / C$	Within $\pm 10\%$ of the value before the test.	
	$\tan\delta$	Must be less than or equal to 1.5 times the initial specified value.	

●Table 1Standard list, TCFG series

## Tantalum capacitors

(P : 2012 A : 3216 B : 3528)

Part No.	Rated voltage at 85°C (V)	Derated voltage at 125°C (V)	Surge voltage at 85°C (V)	Capacitance ( $\mu$ F)	Tolerance (%)	Leakage current at 25°C 1WV.60s ( $\mu$ A)	DF 120Hz 25°C (%)	Case code
TCF GP 0G 225□	4	2.5	5.2	2.2	±20,10	0.5	8	P
TCF GP 0G 335□	4	2.5	5.2	3.3	±20,10	0.5	8	P
TCF GP 0G 475□	4	2.5	5.2	4.7	±20,10	0.5	8	P
TCF GA 0G 475□	4	2.5	5.2	4.7	±20,10	0.5	6	A
TCF GP 0G 685□	4	2.5	5.2	6.8	±20,10	0.5	10	P
TCF GA 0G 685□	4	2.5	5.2	6.8	±20,10	0.5	6	A
TCF GP 0G 106□	4	2.5	5.2	10	±20,10	0.5	10	P
TCF GA 0G 106□	4	2.5	5.2	10	±20,10	0.5	6	A
TCF GP 0G 156□	4	2.5	5.2	15	±20,10	0.6	10	P
TCF GA 0G 156□	4	2.5	5.2	15	±20,10	0.6	6	A
TCF GB 0G 156□	4	2.5	5.2	15	±20,10	0.6	6	B
TCF GA 0G 226□	4	2.5	5.2	22	±20,10	0.9	6	A
TCF GB 0G 226□	4	2.5	5.2	22	±20,10	0.9	6	B
TCF GA 0G 336□	4	2.5	5.2	33	±20,10	1.3	8	A
TCF GB 0G 336□	4	2.5	5.2	33	±20,10	1.3	6	B
TCF GA 0G 476□	4	2.5	5.2	47	±20,10	1.9	8	A
TCF GB 0G 476□	4	2.5	5.2	47	±20,10	1.9	6	B
TCF GB 0G 686□	4	2.5	5.2	68	±20,10	2.7	8	B
TCF GB 0G 107□	4	2.5	5.2	100	±20,10	4.0	8	B
TCF GP 0J 155□	6.3	4	8	1.5	±20,10	0.5	8	P
TCF GP 0J 225□	6.3	4	8	2.2	±20,10	0.5	8	P
TCF GP 0J 335□	6.3	4	8	3.3	±20,10	0.5	8	P
TCF GA 0J 335□	6.3	4	8	3.3	±20,10	0.5	6	A
TCF GP 0J 475□	6.3	4	8	4.7	±20,10	0.5	8	P
TCF GA 0J 475□	6.3	4	8	4.7	±20,10	0.5	6	A
TCF GP 0J 685□	6.3	4	8	6.8	±20,10	0.5	10	P
TCF GA 0J 685□	6.3	4	8	6.8	±20,10	0.5	6	A
TCF GP 0J 106□	6.3	4	8	10	±20,10	0.6	10	P
TCF GA 0J 106□	6.3	4	8	10	±20,10	0.6	6	A
TCF GB 0J 106□	6.3	4	8	10	±20,10	0.6	6	B
TCF GA 0J 156□	6.3	4	8	15	±20,10	0.9	6	A
TCF GB 0J 156□	6.3	4	8	15	±20,10	0.9	6	B
TCF GA 0J 226□	6.3	4	8	22	±20,10	1.4	6	A
TCF GB 0J 226□	6.3	4	8	22	±20,10	1.4	6	B
TCF GA 0J 336□	6.3	4	8	33	±20,10	2.1	8	A
TCF GB 0J 336□	6.3	4	8	33	±20,10	2.1	6	B
TCF GB 0J 476□	6.3	4	8	47	±20,10	3.0	6	B
TCF GB 0J 686□	6.3	4	8	68	±20,10	4.3	8	B

□ Tolerance  
(M : ±20%, K : ±10%)

## Tantalum capacitors

(P : 2012 A : 3216 B : 3528)

Part No.	Rated voltage at 85°C (V)	Derated voltage at 125°C (V)	Surge voltage at 85°C (V)	Capacitance (μF)	Tolerance (%)	Leakage current at 25°C 1WV.60s (μA)	DF 120Hz 25°C (%)	Case code
TCF GP 1A 105□	10	6.3	13	1.0	±20,10	0.5	8	P
TCF GP 1A 155□	10	6.3	13	1.5	±20,10	0.5	8	P
TCF GA 1A 155□	10	6.3	13	1.5	±20,10	0.5	6	A
TCF GP 1A 255□	10	6.3	13	2.2	±20,10	0.5	8	P
TCF GA 1A 225□	10	6.3	13	2.2	±20,10	0.5	6	A
TCF GP 1A 335□	10	6.3	13	3.3	±20,10	0.5	8	P
TCF GA 1A 335□	10	6.3	13	3.3	±20,10	0.5	6	A
TCF GP 1A 475□	10	6.3	13	4.7	±20,10	0.5	8	P
TCF GA 1A 475□	10	6.3	13	4.7	±20,10	0.5	6	A
TCF GB 1A 475□	10	6.3	13	4.7	±20,10	0.5	6	B
TCF GA 1A 685□	10	6.3	13	6.8	±20,10	0.7	6	A
TCF GB 1A 685□	10	6.3	13	6.8	±20,10	0.7	6	B
TCF GA 1A 106□	10	6.3	13	10	±20,10	1.0	6	A
TCF GB 1A 106□	10	6.3	13	10	±20,10	1.0	6	B
TCF GA 1A 156□	10	6.3	13	15	±20,10	1.5	6	A
TCF GB 1A 156□	10	6.3	13	15	±20,10	1.5	6	B
TCF GB 1A 226□	10	6.3	13	22	±20,10	2.2	6	B
TCF GB 1A 336□	10	6.3	13	33	±20,10	3.3	6	B
TCF GB 1A 476□	10	6.3	13	47	±20,10	4.7	6	B
TCF GP 1C 105□	16	10	20	1.0	±20,10	0.5	8	P
TCF GA 1C 105□	16	10	20	1.0	±20,10	0.5	4	A
TCF GA 1C 155□	16	10	20	1.5	±20,10	0.5	6	A
TCF GA 1C 225□	16	10	20	2.2	±20,10	0.5	6	A
TCF GA 1C 335□	16	10	20	3.3	±20,10	0.5	6	A
TCF GB 1C 335□	16	10	20	3.3	±20,10	0.5	6	B
TCF GA 1C 475□	16	10	20	4.7	±20,10	0.8	6	A
TCF GB 1C 475□	16	10	20	4.7	±20,10	0.8	6	B
TCF GA 1C 685□	16	10	20	6.8	±20,10	1.1	6	A
TCF GB 1C 685□	16	10	20	6.8	±20,10	1.1	6	B
TCF GB 1C 106□	16	10	20	10	±20,10	1.6	6	B
TCF GB 1C 156□	16	10	20	15	±20,10	2.4	6	B
TCF GB 1C 226□	16	10	20	22	±20,10	3.5	6	B
TCF GA 1D 105□	20	13	26	1.0	±20,10	0.5	4	A

□ Tolerance  
(M : ±20%, K : ±10%)

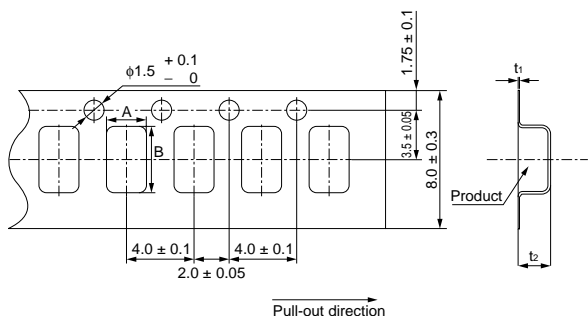
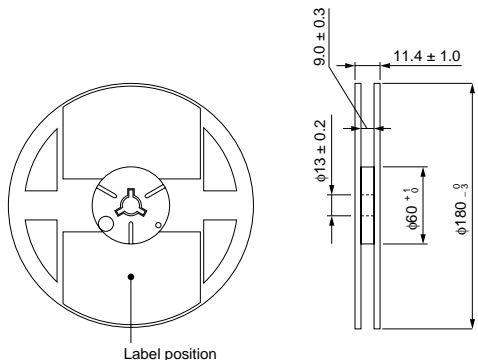

Tantalum capacitors

<p><b>Taping</b></p> <p>TCFG</p>  <table border="1" style="margin-left: auto; margin-right: auto; border-collapse: collapse; text-align: center;"> <thead> <tr> <th>Case code</th> <th>A ± 0.1</th> <th>B ± 0.1</th> <th>t<sub>1</sub> ± 0.05</th> <th>t<sub>2</sub> ± 0.1</th> </tr> </thead> <tbody> <tr> <td>P (2012)</td> <td>1.55</td> <td>2.3</td> <td>0.25</td> <td>1.5</td> </tr> <tr> <td>A (3216)</td> <td>1.9</td> <td>3.5</td> <td>0.25</td> <td>1.9</td> </tr> <tr> <td>B (3528)</td> <td>3.3</td> <td>3.8</td> <td>0.25</td> <td>2.2</td> </tr> </tbody> </table> <p style="font-size: small;">Some emboss tapes have the center hole on its bottom.</p>	Case code	A ± 0.1	B ± 0.1	t <sub>1</sub> ± 0.05	t <sub>2</sub> ± 0.1	P (2012)	1.55	2.3	0.25	1.5	A (3216)	1.9	3.5	0.25	1.9	B (3528)	3.3	3.8	0.25	2.2	<p><b>Reel</b></p> <p>Plastic reel</p>  <p style="text-align: right; font-size: small;">EIAJ ETX - 7001comformed</p>
Case code	A ± 0.1	B ± 0.1	t <sub>1</sub> ± 0.05	t <sub>2</sub> ± 0.1																	
P (2012)	1.55	2.3	0.25	1.5																	
A (3216)	1.9	3.5	0.25	1.9																	
B (3528)	3.3	3.8	0.25	2.2																	

●Packaging style

Part No.	Package type	Packaging style		Symbol	Basic ordering unit (pcs)
TCFG	Taping	Plastic taping	φ180 mm reel	R	2,000

Tantalum capacitors

● Electrical characteristics and operation notes

(1) Soldering conditions (soldering temperature and soldering time)

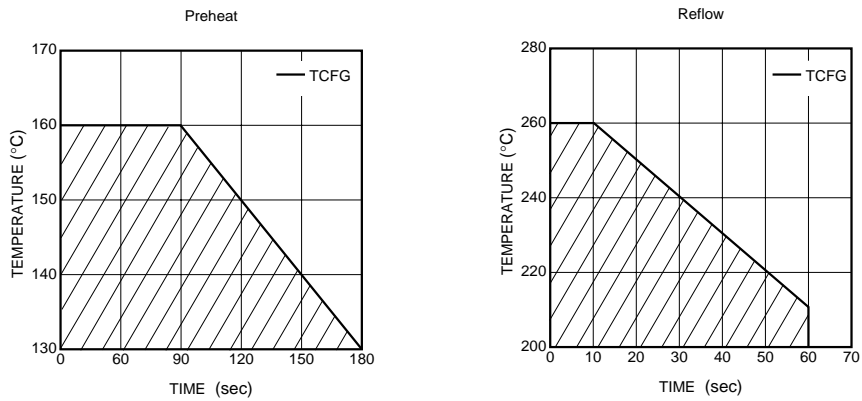

Fig.1 Reflow (Infrared Ray, Hot Plate, Hot Air)

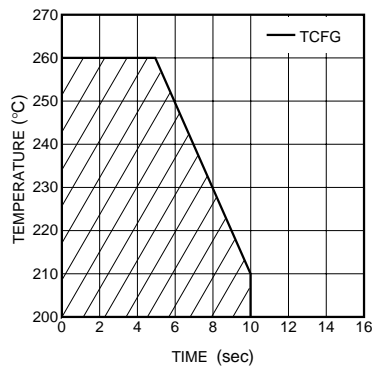

Fig.2 Flow (Dipping wave soldering)

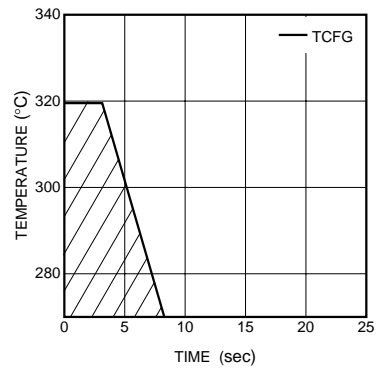

Fig.3 Hand soldering (soldering gun output: 30W or less)

(2) Leakage current-to-voltage ratio

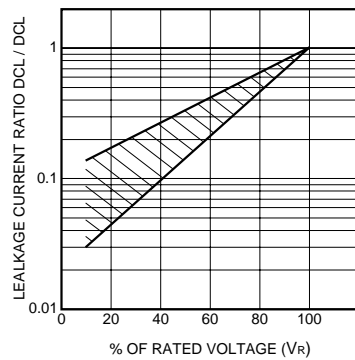

Fig.4

Tantalum capacitors

(3) Derating voltage as function of temperature

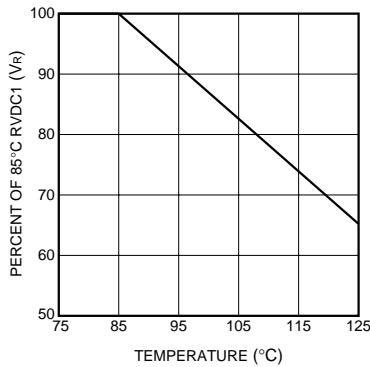

Fig.5

85°C		125°C	
Rated Voltage (V.DC)	Surge Voltage (V.DC)	Category Voltage (V.DC)	Surge Voltage (V.DC)
4	5.2	2.5	3.4
6.3	8	4	5
10	13	6.3	9
16	20	10	12
20	26	13	16

(4) Reliability

The malfunction rate of tantalum solid state electrolytic capacitors varies considerably depending on the conditions of usage (ambient temperature, applied voltage, circuit resistance).

Formula for calculating malfunction rate

$$\lambda_p = \lambda_b \times (\pi_E \times \pi_{SR} \times \pi_Q \times \pi_{CV})$$

- $\lambda_p$  : Malfunction rate stemming from operation
- $\lambda_b$  : Basic malfunction rate
- $\pi_E$  : Environmental factors
- $\pi_{SR}$  : Series resistance
- $\pi_Q$  : Level of malfunction rate
- $\pi_{CV}$  : Capacitance

For details on how to calculate the malfunction rate stemming from operation, see the tantalum solid state electrolytic capacitors column in MIL-HDBK-217.

Malfunction rate as function of operating temperature and rated voltage

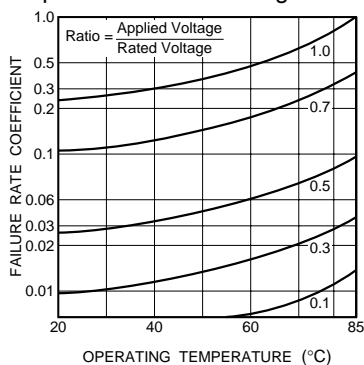

Fig.6

Malfunction rate as function of circuit resistance ( $\Omega/V$ )

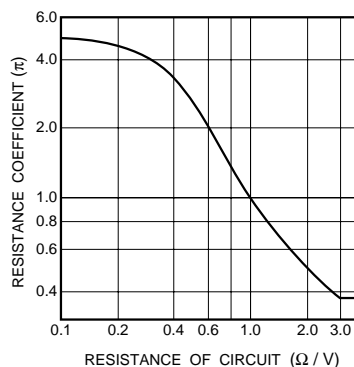

Fig.7

Tantalum capacitors

(5) External temperature vs. fuse blowout

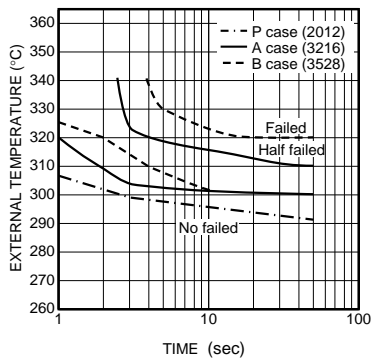

Fig.8

(6) Power vs. fuse blowout characteristics / Product surface temperature

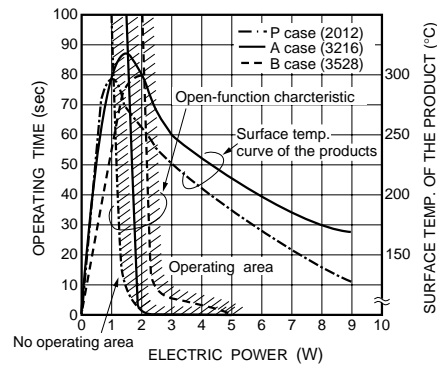

Fig.9

Note: Solder the chip at 300°C or less. If it is soldered using a temperature higher than 300°C, open function built-in may operate.

(7) Maximum power dissipation

Warming of the capacitor due to ripple voltage balances with warming caused by Joule heating and by radiated heat. Maximum allowable warming of the capacitor is to 5°C above ambient temperature. When warming exceeds 5°C, it can damage the dielectric and cause a short circuit.

$$\text{Power dissipation (P)} = I^2 \cdot R$$

Ripple current

P : As shown in table at right

R : Equivalent series resistance

Notes:

1. Please be aware that when case size is changed, maximum allowable power dissipation is reduced.
2. Maximum power dissipation varies depending on the package. Be sure to use a case which will keep warming within the limits shown in the table below.

Allowable power dissipation (W) and maximum temperature rising

Ambient temp.	+25°C	+55°C	+85°C	+125°C
Case				
P case (2012)	0.025	0.022	0.020	0.010
A case (3216)	0.070	0.063	0.056	0.028
B case (3528)	0.080	0.072	0.064	0.032
Max. temp. rise	5	5	5	2

Tantalum capacitors

(8) Impedance frequency characteristics

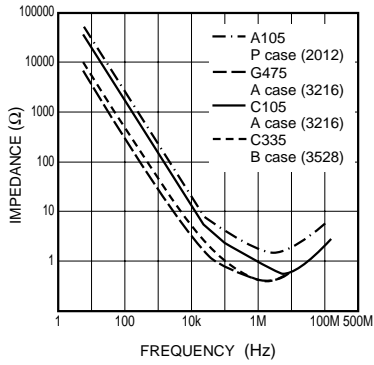

Fig.10

(9) ESR frequency characteristics

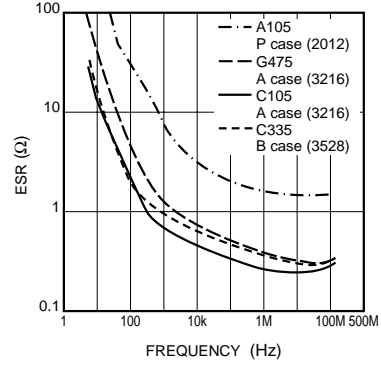

Fig.11

(10) Temperature characteristics

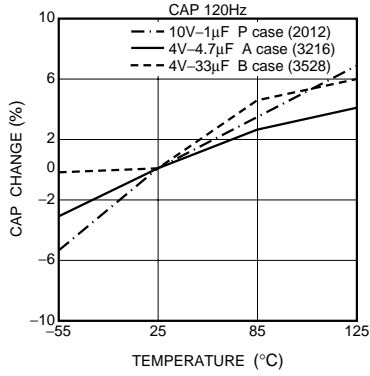

Fig.12

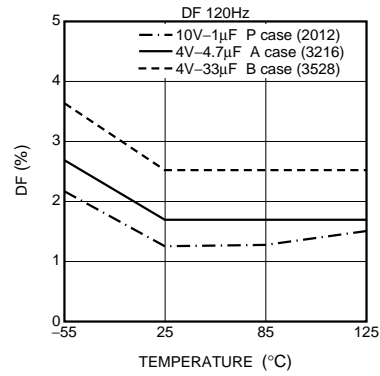

Fig.13

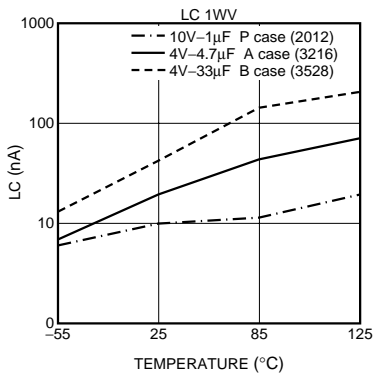

Fig.14

Tantalum capacitors

Inrush current

Beware of inrush current.  
Inrush currents are inversely proportional to ESR. Large inrush currents can cause component failure.

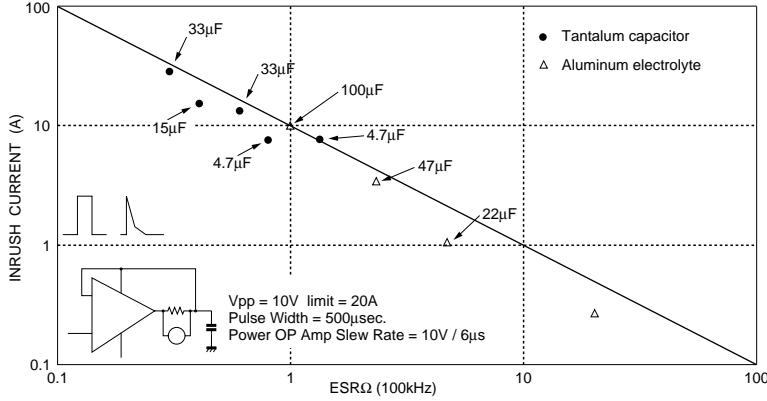

Fig.16 Maximum inrush current and ESR

Inrush current can be limited by means of a protective resistor.

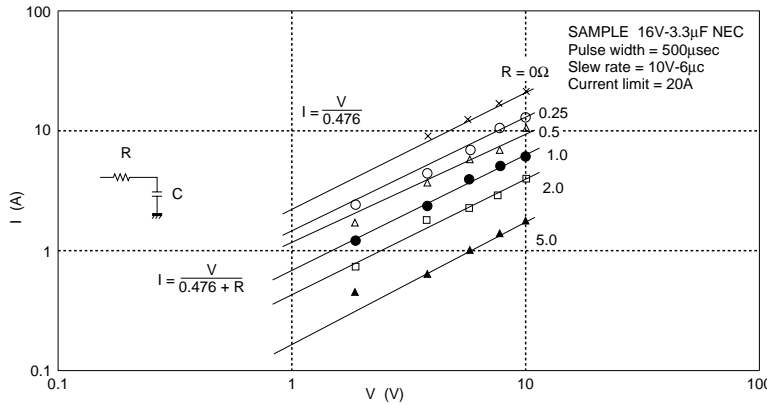

Fig.17 I<sub>max</sub> change due to protective resistor R

(11) Ultrasonic cleaning

Carry out cleaning under the mildest conditions possible. The internal element of a tantalum capacitor are larger than those of a transistor or diode, so it is not as resistant to ultrasonic waves.

Example : water  
Propagation speed 1500m / s  
Solvent density 1g / cm<sup>3</sup>

Frequency and wavelength

Frequency	Wavelength
20kHz	7.5cm
28kHz	5.3cm
50kHz	3.0cm

Precautions

## Tantalum capacitors

---

- 1) Do not allow solvent to come to a boil (kinetic energy increases).
  - Ultrasonic output 0.5W / cm<sup>2</sup> or less
  - Use a solvent with a high boiling point.
  - Lower solvent temperature.
- 2) Ultrasonic cleaning frequency  
28 kHz or less
- 3) Keep cleaning time as short as possible.
- 4) Move item being cleaned.  
Standing waves caused by the ultrasonic waves can cause stress to build up in part of the item being cleaned.

### Reference

$$\text{Kinetic energy} = 2 \times \pi \times \text{frequency} \times \sqrt{\frac{2 \times \text{ultrasonic output}}{\text{propagation speed} \times \text{solvent density}}}$$

### Notes

- No technical content pages of this document may be reproduced in any form or transmitted by any means without prior permission of ROHM CO.,LTD.
- The contents described herein are subject to change without notice. The specifications for the product described in this document are for reference only. Upon actual use, therefore, please request that specifications to be separately delivered.
- Application circuit diagrams and circuit constants contained herein are shown as examples of standard use and operation. Please pay careful attention to the peripheral conditions when designing circuits and deciding upon circuit constants in the set.
- Any data, including, but not limited to application circuit diagrams information, described herein are intended only as illustrations of such devices and not as the specifications for such devices. ROHM CO.,LTD. disclaims any warranty that any use of such devices shall be free from infringement of any third party's intellectual property rights or other proprietary rights, and further, assumes no liability of whatsoever nature in the event of any such infringement, or arising from or connected with or related to the use of such devices.
- Upon the sale of any such devices, other than for buyer's right to use such devices itself, resell or otherwise dispose of the same, no express or implied right or license to practice or commercially exploit any intellectual property rights or other proprietary rights owned or controlled by
- ROHM CO., LTD. is granted to any such buyer.
- Products listed in this document use silicon as a basic material.  
Products listed in this document are no antiradiation design.

The products listed in this document are designed to be used with ordinary electronic equipment or devices (such as audio visual equipment, office-automation equipment, communications devices, electrical appliances and electronic toys).

Should you intend to use these products with equipment or devices which require an extremely high level of reliability and the malfunction of which would directly endanger human life (such as medical instruments, transportation equipment, aerospace machinery, nuclear-reactor controllers, fuel controllers and other safety devices), please be sure to consult with our sales representative in advance.

#### About Export Control Order in Japan

Products described herein are the objects of controlled goods in Annex 1 (Item 16) of Export Trade Control Order in Japan.

In case of export from Japan, please confirm if it applies to "objective" criteria or an "informed" (by MITI clause) on the basis of "catch all controls for Non-Proliferation of Weapons of Mass Destruction.