

PCM-5862E/EL

All in one multi-media Pentium processor-based single board computer with audio, SVGA, Ethernet and PCI expansion slot.

User's Manual for PCM-5862E/EL

Copyright Notice

This document is copyrighted, 1997. All rights are reserved. The original manufacturer reserves the right to make improvements to the products described in this manual at any time without notice.

No part of this manual may be reproduced, copied, translated or transmitted in any form or by any means without the prior written permission of the original manufacturer. Information provided in this manual is intended to be accurate and reliable. However, the original manufacturer assumes no responsibility for its use, or for any infringements upon the rights of third parties that may result from its use.

Acknowledgements

AMD is a trademark of Advanced Micro Devices, Inc.

Award is a trademark of Award Software International, Inc.

C&T is a trademark of Chips and Technologies, Inc.

Cyrix is a trademark of Cyrix Corporation.

IBM, PC/AT, PS/2 and VGA are trademarks of International Business Machines Corporation.

Intel and Pentium are trademarks of Intel Corporation.

Microsoft Windows[®] is a registered trademark of Microsoft Corp.

RTL is a trademark of Realtek Semi-Conductor Co., Ltd.

SiS is a trademark of Silicon Integration Systems Corporation

SMC is a trademark of Standard Microsystems Corporation.

UMC is a trademark of United Microelectronics Corporation.

VIA is a trademark of VIA Technology, Inc.

IDT is a trademark of Intergrated Device Technology , Inc.

All other product names or trademarks are properties of their respective owners.

Packing list

Before you begin installing your card, please make sure that the following materials have been shipped:

- 1 PCM-5862E/5862EL All-in-One Single Board Computer
- 1 Ethernet driver disk
- 2 utility disks with PCI SVGA utility programs and drivers for Windows 3.1, Windows 95, Windows NT 4.0, and OS/2
- 1 audio driver disks for Windows 3.1, Windows 95, and DOS utility program. (PCM-5862E only)

If any of these items are missing or damaged, contact your distributor or sales representative immediately.

Please refer to page 98 for the optional interface wiring kit.

Contents

Chapter 1 General Information	1
Introduction	2
Highly integrated multi-media SBC	2
Features	3
Specifications	3
Standard SBC functions	3
PCI SVGA/flat panel interface:	4
Audio function: (PCM-5862E only)	4
PCI Bus Ethernet Interface:	5
Mechanical and environmental	5
Board layout and dimensions	5
Chapter 2 Installation	7
Jumpers	8
Connectors	9
Locating jumpers	10
Locating connectors	11
CPU installation and upgrading	13
Install a CPU in the ZIF socket	13
System clock setting (J1, J2, and J4)	14
CPU Speed Reference Table	14
System/PCI clock setting	15
CPU frequency ratio	15
Pentium MMX(P55C) enabled/disabled (JP2)	15
CPU voltage setting (JP1)	16
M1 cache linear mode setting (J5)	16
CMOS clear (J6)	17
Buzzer enabled/disabled (J7)	17
Installing DRAM (SIMMs)	17
Installing SIMMs	17
IDE hard drive connector (CN17)	18
Connecting the hard drive	18
Floppy drive connector (CN18)	19
Connecting the floppy drive	19
Parallel port connector (CN19)	20

Keyboard and PS/2 mouse connector (CN15)	20
Front panel connector (CN7)	20
Speaker	21
LED interface	21
Watchdog output	21
Reset switch	21
Power connectors (CN6, CN10, CN14)	21
Peripheral power connector, -5V, -12V (CN10)	21
Main power connector, +5V, +12V (CN14)	21
Fan power supply connector (CN6)	21
ATX Power Control Connector (CON1, CON2)	22
ATX feature connector (CON1) and soft power switch connector (CON2)	22
IR connector (CN12)	23
Audio interfaces (CN8, CN13)	23
Audio connector (CN13)	23
CD audio input connector (CN8)	23
Audio power source setting (J16)	24
Audio power source setting	24
COM-port connector (CN16)	25
COM2 RS-232/422/485 setting (J14, J15)	25
COM3/COM4 RI pin setting (J11, J12)	26
VGA interface connections	27
CRT display connector (CN1)	27
Flat panel display connector (CN2)	27
LCD power setting (J10)	28
Ethernet configuration	29
100BASE-T connector (CN11)	29
Network boot	29
Watchdog timer configuration	30
Watchdog timer action (J13)	30
USB connectors (CN4, CN5)	31

Chapter 3 Software Configuration33

Introduction	34
Connections for five standard LCDs	34
Connections to Sharp LM64183P, LM64P89	34
Connections to PLANAR EL	35
Connections to Toshiba LTM10C042	36
Connections to Sharp LM64C142	37
Connections to Toshiba LTM12C275A	38

Ethernet software configuration	39
System test and initialization	40
System configuration verification	40

Chapter 4 Award BIOS Setup 41

System test and initialization	42
System configuration verification	42
AWARD BIOS setup	43
Entering setup	43
Standard CMOS setup	44
BIOS features setup	45
CHIPSET features setup	46
Power management setup	47
PnP/PCI Configuration	48
Integrated Peripherals	49
Load BIOS defaults	50
Change Password	51
Auto detect hard disk	52
Save & exit setup	52
Exit without saving	52

Chapter 5 PCI SVGA Setup 53

Before you begin	54
Installation	54
Simultaneous display mode	55
Sleep mode	55
Driver installation	56
Necessary prerequisites	56
Before you begin	56
Windows setup	57
Changing Display Drivers in Windows	57
Changing Color Schemes	57
DOS Setup	58
Changing Display Drivers in DOS	59
Panning Drivers	59
Linear Acceleration Drivers	59
Windows 95 Drivers Setup Procedure	59
Windows NT Drivers Setup Procedure	60
Step 1	60
Step 2	60
Step 3	60

OS/2 Drivers Setup Procedure	61
Preliminary Steps	61
Installing from Diskette	61
Selecting Monitor Type	63
Selecting Screen Resolution/Refresh Rate	63
Installation Notes	64
Chapter 6 Audio Setup	65
Introduction	66
DOS Utilities	66
Changing setting in DOS	66
Controlling volume in DOS	67
Driver Installation	68
Before you begin	68
Windows 3.1 drivers	68
Windows 95 Drivers	69
Appendix A The Watchdog Timer	71
Programming the Watchdog Timer	72
Appendix B Installing PC/104 Modules	73
B.1 Installing PC/104 modules	74
Figure B-1: PC/104 module mounting diagram	74
Figure B-2: PC/104 module dimensions (mm) (± 0.1)	74
Appendix C Pin Assignments	77
CRT display connector (CN1)	78
Flat panel display connector (CN2)	79
PC/104 connectors (CN3, CN9)	80
USB connectors (CN4, CN5)	82
Fan power connector (CN6)	82
Front panel connector (CN7)	83
CD audio connector (CN8)	84
Peripheral power connector (CN10)	84
Ethernet 10BASE-T connector (CN11)	85
IR connector (CN12)	85
Audio connector (CN13)	86
Main power connector (CN14)	86
Keyboard and PS/2 mouse connector (CN15)	87
COM port connector (CN16)	88

IDE hard drive connector (CN17)	90
Floppy drive connector (CN18)	91
Parallel port connector (CN19)	92
ATX Power Feature Connector (CON1)	93
ATX Soft Power Switch Connector (CON2)	93
System I/O Ports	94
1st MB Memory Map	95
DMA Channel Assignments	95
IRQ mapping chart	96

Appendix D Optional Extras 97

PCM-10586-2 Cable kit for PCM-5862E/5862EL	98
USB Cables & LCD Cables	99

General Information

This chapter gives background information on the PCM-5862E/5862EL

Sections include:

- Introduction
- Features
- Specifications
- Board layout and dimensions

Introduction

The PCM-5862E/5862EL is an all-in-one multi-media Pentium processor-based single board computer (SBC) with a 16-bit audio controller, a PCI SVGA controller, a PCI 100/10 base-T Ethernet interface, and one PCI expansion slot. When using an Intel MMX Pentium processor, the PCM-5862E/5862EL achieves outstanding performance that surpasses any other SBC in its class. This compact (only 5.75" x 8") unit offers all the functions of a single board industrial computer, but still fits in the space of a 5.25" floppy drive.

On-board features include 512 KB 2nd level cache, four serial ports (three RS-232, one RS-232/422/485), one multi-mode parallel (ECP/EPP/SPP) port, two USB (Universal Serial Bus) ports, a floppy drive controller and a keyboard/PS/2 mouse interface. The built-in high speed PCI IDE controller supports both PIO and bus master modes. Up to two IDE devices can be connected, including large hard disks, CD-ROM drives, and tape backup drives.

The PCM-5862E/5862EL features power management to minimize power consumption. It complies with the "Green Function" standard and supports Doze mode, Standby mode and Suspend mode. In addition, the board's watchdog timer can automatically reset the system or generate an interrupt in case the system stops due to a program bug or EMI.

Highly integrated multi-media SBC

The PCM-5862E/5862EL is a highly integrated multi-media SBC that combines audio, video, and network functions on a single computer board the size of a 5.25" floppy drive. It provides 16-bit half-duplex, 8-bit full-duplex, integrated 3D audio and up to 1024 x 768 resolution @ 64K colors with 2MB display memory. Major on-board devices adopt PCI technology to achieve outstanding computing performance when used with Intel Pentium processors, making the PCM-5862E/5862EL the world's smallest and most powerful all-in-one multimedia board.

Features

- Accepts Intel MMX Pentium, AMD K6, and Cyrix 6x86MX, IDT WinChip C6
- 32-bit PCI-bus SVGA/LCD controller supports LCD & CRT display
- 100/10Base-T Ethernet interface, IEEE 802.3U compatible
- 16-bit audio interface, Sound Blaster Pro compatible
- 4 serial ports (three RS-232 and one RS-232/422/485)
- USB interface, PCI slot, and PC/104 connector for flexible expansion capabilities
- Watchdog timer with jumperless selection
- Switching power for full range Pentium MMX level processors

Specifications

Standard SBC functions

- **CPU:** Intel Pentium MMX up to 233MHz
AMD K6 up to 300MHz
Cyrix 6x86MX-PR166, PR200, PR233
IDT WinChip C6 up to 200MHz,
- **BIOS:** AWARD 256KB Flash BIOS, supports Plug&Play, APM
- **Chipset:** SiS 5571
- **Green function:** APM 1.1 compliant
- **2nd level cache:** On board 512 KB Pipelined Burst SRAM
- **RAM:** Two 72-pin SIMM sockets accept 8~128 MB EDO/FPM DRAM
- **Enhanced IDE interface:** Supports 2 IDE devices
- **FDD interface:** Supports up to two FDDs (360K/1.2M/720K/1.44MB/ 2.88MB)

- **Parallel port:** One parallel port, supports SPP/EPP/ECP parallel mode
- **Serial port:** Four serial ports with three RS-232 (COM1, 3, 4) and one RS-232/422/485 (COM2). All ports with 16C550 compatible UARTs.
- **Watchdog timer:** 63-level interval from 1 to 63 seconds. Generates system reset or IRQ15. Jumperless selection and software enabled/disabled.
- **Keyboard/Mouse connector:** 8-pin header connector for keyboard and PS/2 mouse
- **USB interface:** Two USB connectors with fuse protection. Compliant with USB Spec. Rev. 1.0
- **PC/104 expansion:** 104-pin 16-bit PC/104 module connector
- **I/O bus expansion:** One 32-bit PCI bus expansion slot
- **Switch voltage regulator:** To support a full range of processor voltage requirements. A solution for processor overheating.

PCI SVGA/flat panel interface:

- **Chipset:** C&T 65550
- **Display memory:** 1 MB on-board memory, supports up to 2 MB
- **Display type:** Simultaneously supports CRT and flat panel (EL, LCD and gas plasma) displays
- **Display resolution:** Supports non-interlaced CRT and LCD display up to 1024x768@256 colors with 1MB VGA memory or 1024x768@64K colors with 2MB(PCM-5862E only)

Audio function: (PCM-5862E only)

- **Chipset:** ESS 1868
- **Audio controller:** 16-bit codec, Sound Blaster Pro compatible
- **Stereo sound:** 8-bit full-duplex, 16-bit half-duplex integrated 3D audio
- **Audio interface:** Microphone in, Line in, CD audio in; Line out, Speaker L, Speaker R
- **Power:** Accepts +12 V source for improved audio quality

PCI Bus Ethernet Interface:

- **Chipset:** REALTEK RTL8139A PCI local bus Ethernet controller
- **Ethernet Interface:** IEEE 802.3U compatible 100/10BaseT interface. Includes software drivers & boot ROM

Mechanical and environmental

- **Max. power requirements:** 7A @ 5V (4.75V to 5.25V)
- **Operating temperature:** 0 to 60° C (32 to 140° F)
- **Size:** 203 mm (L) x 146 mm (W) (8" x 5.75")
- **Weight:** 0.32 kg (0.7 lbs.) (w/o package)

Board layout and dimensions

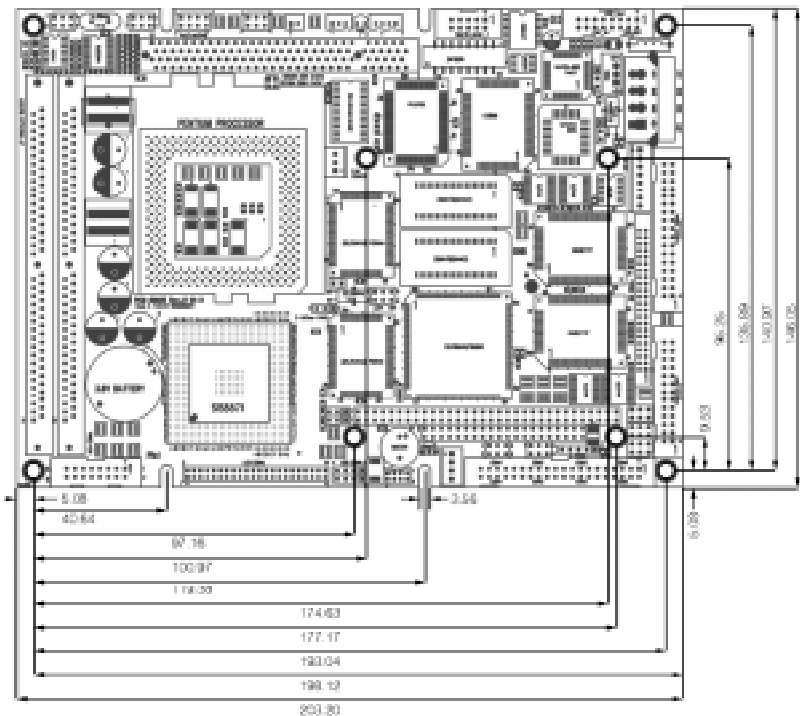

PCM-5862E/5862EL dimensions

CHAPTER 2

Installation

This chapter tells how to set up the PCM-5862E/5862EL hardware, including instructions on setting jumpers and connecting peripherals, switches and indicators. Be sure to read all the safety precautions before you begin the installation procedure.

Jumpers

The PCM-5862E/5862EL has a number of jumpers that allow you to configure your system to suit your applications. The table below lists the function of each of the board's jumpers.

Jumpers	
Label	Function
JP1	CPU voltage setting
JP2	Pentium MMX enable/disable
J1	System/PCI clock setting
J2	System/PCI clock setting
J4	CPU frequency ratio setting
J5	M1 cache linear mode setting
J6	CMOS clear
J7	Buzzer enable/disable
J10	LCD power setting
J11	COM4 RI pin setting
J12	COM3 RI pin setting
J13	Watchdog timer action
J14	COM2 RS-232/422/485 setting
J15	COM2 RS-232/422/485 setting
J16	Audio power source setting

Connectors

On-board connectors link the PCM-5862E/5862EL to external devices such as hard disk drives, a keyboard, or floppy drives. The table below lists the function of each of the board's connectors.

Connectors	
Label	Function
CN1	CRT display connector
CN2	Flat panel display connector
CN3	PC/104 ISA-bus expansion
CN4	USB channel 1 connector
CN5	USB channel 2 connector
CN6	Fan power connector
CN7	Front panel connector
CN8	CD audio input connector
CN9	PC/104 ISA-bus expansion
CN10	Peripheral power connector
CN11	Ethernet 100/10Base-T connector
CN12	IR connector
CN13	Audio connector
CN14	Main power connector
CN15	Keyboard and PS/2 mouse connector
CN16	COM-port connector
CN17	IDE hard drive connector
CN18	Floppy drive connector
CN19	Parallel port connector
CON1	ATX feature connector
CON2	ATX soft power connector switch

Please refer to Appendix C for pin assignment.

Locating jumpers

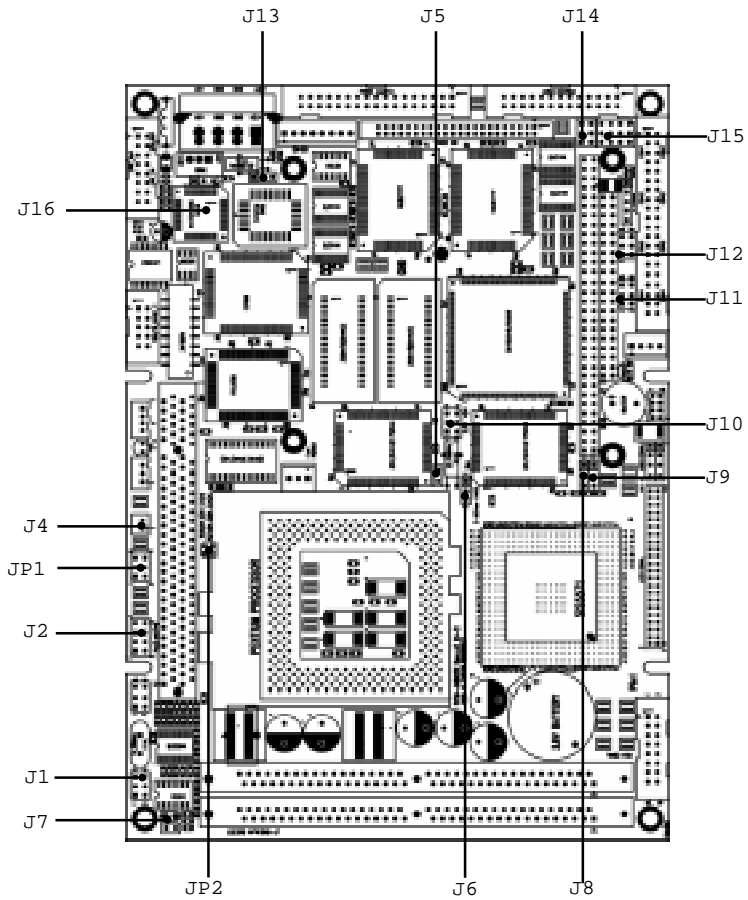

Locating connectors

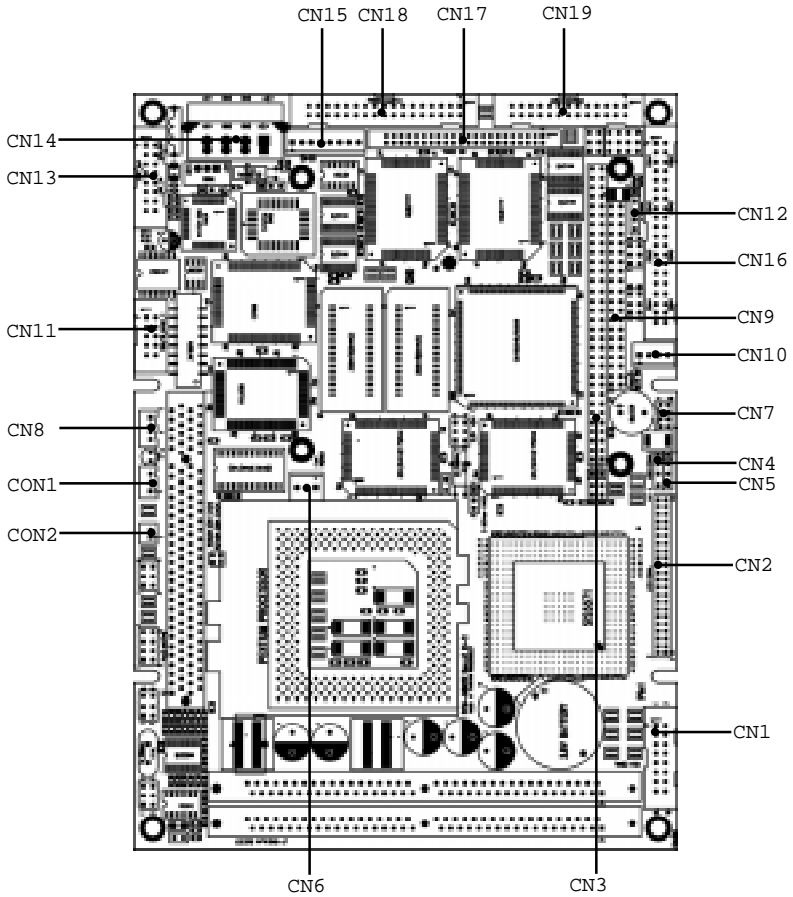

Setting jumpers

You configure your card to match the needs of your application by setting jumpers. A jumper is the simplest kind of electric switch. It consists of two metal pins and a small metal clip (often protected by a plastic cover) that slides over the pins to connect them. To “close” a jumper you connect the pins with the clip. To “open” a jumper you remove the clip. Sometimes a jumper will have three pins, labeled 1, 2, and 3. In this case you would connect either pins 1 and 2 or 2 and 3.

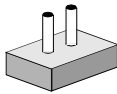

Open

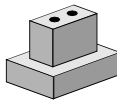

Closed

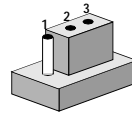

Closed 2-3

The jumper settings are schematically depicted in this manual as follows:



Open



Closed

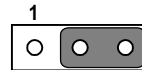

Closed 2-3

A pair of needle-nose pliers may be helpful when working with jumpers.

If you have any doubts about the best hardware configuration for your application, contact your local distributor or sales representative before you make any changes.

Generally, you simply need a standard cable to make most connections.

CPU installation and upgrading

You can upgrade to a higher power Pentium processor at any time. Simply remove the old CPU, install the new one, and set the jumpers for the new CPU type and speed.

Warning!  Always disconnect the power cord from your chassis when you are working on it. Do not make connections while the power is on as sensitive electronic components can be damaged by the sudden rush of power. Only experienced electronics personnel should open the PC chassis.

Caution!  Always ground yourself to remove any static charge before touching the PC board. Modern electronic devices are very sensitive to static electric charges. Use a grounding wrist strap at all times. Place all electronic components on a static-dissipative surface or in a static-shielded bag when they are not in the chassis.

Install a CPU in the ZIF socket

PCM-5862E/5862EL provides a Zero Insertion Force (ZIF) socket for easy CPU installation.

1. Make sure the ZIF socket lever is in the upright position. To raise the lever, pull it out to the side a little and raise it as far as it will go.
2. Place the CPU in the empty socket. Follow the instructions that came with the CPU. If you have no instructions, do the following: Carefully align the CPU so it is parallel to the socket and the notch on the corner of the CPU corresponds with the notch on the inside of the socket. Gently slide the CPU in. It should insert easily. If it doesn't, pull the lever up a little more.

3. Press the lever down. The plate will slide forward. You will feel some resistance as the pressure starts to secure the CPU in the socket. This is normal and won't damage the CPU.

When the CPU is installed, the lever should snap into place at the side of the socket.

NOTE: *To remove a CPU, pull the lever out to the side a little and raise it as far as it will go. Lift out the CPU chip.*

When you install a new CPU, be sure to adjust the board settings, such as CPU type and CPU clock. **Improper settings may damage the CPU.**

System clock setting (J1, J2, and J4)

J1, J2 and J4 are used to set the CPU and PCI bus speed to optimize the system performance. The system chipset will sense the J1 setting to get the bus frequency, then adjust its internal timing. J2 is used to set the CPU and PCI clock. J4 is the CPU clock ratio setting jumper. Refer to the CPU Speed Reference Table (below) for instructions on adjusting the internal clocks according to the base CPU speed.

CPU Speed Reference Table									
CPU Speed (MHz)	75	100	*133	150	166	200	233	266	300
Clock setting	50	66	66	60	66	66	66	66	66
Frequency ratio	1.5	1.5	2	2.5	2.5	3	3.5	4	4.5

*** default setting**

System/PCI clock setting

System	50MHz	50MHz	60MHz	*66MHz	75MHz
PCI	25MHz	33.3MHz	30MHz	*33.3MHz	32MHz
J1					
	2 4 6	2 4 6	2 4 6	2 4 6	2 4 6
J2					
	2 4 6	2 4 6	2 4 6	2 4 6	2 4 6

CPU frequency ratio

	1.5/3.5	*2	2.5	3	4
J4					
	2 4 6	2 4 6	2 4 6	2 4 6	2 4 6
J4 cont.					
	2 4 6	2 4 6	2 4 6		

Pentium MMX(P55C) enabled/disabled (JP2)

	P55C enabled	*P55C disabled
JP2		

* default setting

CPU voltage setting (JP1)



JP1 must be set to match the CPU type. The chart below shows the proper jumper settings for their respective $V_{CC(CORE)}$. (The $V_{CC(I/O)}$ for CPU is fixed to be 3.3V)

CPU voltage setting JP1				
$V_{CC(CORE)}$	1-2	3-4	5-6	7-8
NONE	open	open	open	open
2.10V	closed	open	open	open
2.20V	open	closed	open	open
2.30V	closed	closed	open	open
2.40V	open	open	closed	open
2.50V	closed	open	closed	open
2.60V	open	closed	closed	open
2.70V	closed	closed	closed	open
2.80V	open	open	open	closed
2.90V	closed	open	open	closed
3.00V	open	closed	open	closed
3.10V	closed	closed	open	closed
3.20V	open	open	closed	closed
3.30V*	closed	open	closed	closed
3.40V	open	closed	closed	closed
3.50V	closed	closed	closed	closed

* default setting

M1 cache linear mode setting (J5)

PCM-5862E/5862EL supports Cyrix M1 CPU with its linear access mode on L2 cache. This mode is set through J5.

M1 cache linear mode enabled/disabled		
	Enabled	*Disabled
J5		

* default setting

CMOS clear (J6)

Warning: To avoid damaging the computer, always turn off the power supply before setting “Clear CMOS.” Set the jumper back to “3.6V Battery On” before turning on the power supply.

CMOS clear	
* 3.6V Battery On	Clear CMOS
J6	

* default setting

Buzzer enabled/disabled (J7)

Buzzer enabled/disabled	
*Enabled	Disabled
J7	

* default setting

Installing DRAM (SIMMs)

The PCM-5862E/5862EL CPU card provides two 72-pin SIMM (Single In-line Memory Module) sockets and supports either Fast Page Mode (FPM) or Extended Data Output (EDO) DRAM with a speed of 70 ns or faster. You can install from 8 MB to 128 MB of RAM.

Installing SIMMs

NOTE: *The modules can only fit into a socket one way. Their chips must face the CPU, and their gold pins must point down into the SIMM socket.*

1. Ensure that all power sources are disconnected.

2. Slip the memory module into the socket at a 45-degree angle.
3. Push the module toward the vertical posts at both ends of the socket until the module is upright, and the retaining clips at both ends of the module click into place. When positioned correctly, the pins on top of the vertical posts should correspond to the circular holes on the ends of the module.
4. Repeat steps 2 and 3 for each module you install.

IDE hard drive connector (CN17)

You can attach one or two Enhanced Integrated Device Electronics hard disk drives to the PCM-5862E/5862EL's internal controller. The PCM-5862E/5862EL's IDE controller uses a PCI local-bus interface. This advanced IDE controller supports faster data transfer, PID mode 3, mode 4.

Connecting the hard drive

Connecting drives is done in a daisy-chain fashion and requires one of two cables (not included in this packing), depending on the drive size. 1.8" and 2.5" drives need a 1 x 44-pin to 2 x 44-pin flat-cable connector. 3.5" drives use a 1 x 44-pin to 2 x 40-pin connector.

Wire number 1 on the cable is red or blue, and the other wires are gray.

1. Connect one end of the cable to CN17. Make sure that the red (or blue) wire corresponds to pin 1 on the connector, which is labeled on the board (on the right side).
2. Plug the other end of the cable to the Enhanced IDE hard drive, with pin 1 on the cable corresponding to pin 1 on the hard drive. (See your hard drive's documentation for the location of the connector.)

Connect a second drive as described above.

Unlike floppy drives, IDE hard drives can connect to either end of the cable. If you install two drives, you will need to set one as the master and one as the slave by using jumpers on the drives. If you install just one drive, set it as the master.

Floppy drive connector (CN18)

You can attach up to two floppy drives to the PCM-5862E/5862EL's on-board controller. You can use any combination of 5¼" (360 KB and 1.2 MB) and/or 3½" (720 KB, 1.44 MB, and 2.88 MB) drives.

A 34-pin daisy-chain drive connector cable is required for a dual-drive system. On one end of the cable is a 34-pin flat-cable connector. On the other end are two sets of floppy disk drive connectors. Each set consists of a 34-pin flat-cable connector (usually used for 3½" drives) and a printed-circuit board connector (usually used for 5¼" drives).

Connecting the floppy drive

1. Plug the 34-pin flat-cable connector into CN18. Make sure that the red wire corresponds to pin one on the connector.
2. Attach the appropriate connector on the other end of the cable to the floppy drive(s). You can use only one connector in the set. The set on the end (after the twist in the cable) connects to the A: drive. The set in the middle connects to the B: drive.
3. If you are connecting a 5¼" floppy drive, line up the slot in the printed circuit board with the blocked-off part of the cable connector.

If you are connecting a 3½" floppy drive, you may have trouble determining which pin is pin number one. Look for a number printed on the circuit board indicating pin number one. In addition, the connector on the floppy drive connector may have a slot. When the slot is up, pin number one should be on the right. Check the documentation that came with the drive for more information.

If you desire, connect the B: drive to the connectors in the middle of the cable as described above.

If you need to make your own cable, you can find the pin assignments for the board's connector in Appendix C.

Parallel port connector (CN19)

Normally, the parallel port is used to connect the card to a printer. The PCM-5862E/5862EL includes a multi-mode (ECP/EPP/SPP) parallel port, accessed through CN19, a 26-pin flat-cable connector. You will need an adapter cable if you use a traditional DB-25 connector. The adapter cable has a 26-pin connector on one end and a DB-25 connector on the other.

The parallel port is designated as LPT1 and can be disabled or changed to LPT2 or LPT3 in the system BIOS setup.

The parallel port interrupt channel is designated to be IRQ7.

You can select ECP/EPP DMA channel via BIOS setup.

Keyboard and PS/2 mouse connector (CN15)

The PCM-5862E/5862EL board provides a keyboard connector that supports both a keyboard and a PS/2 style mouse. In most cases, especially in embedded applications, a keyboard is not used. The standard PC/AT BIOS will report an error or fail during power-on self-test (POST) after a reset if the keyboard is not present. The PCM-5862E/5862EL's BIOS standard setup menu allows you to select "All, But Keyboard" under the "Halt On" selection. This allows no-keyboard operation in embedded system applications without the system halting under POST (power-on-self-test).

Front panel connector (CN7)

Next, you may want to install external switches to monitor and control the PCM-5862E/5862EL. These features are optional — install them only if you need them. The front panel connector (CN7) is an 8-pin male, dual in-line header and provides connections for a speaker, hard disk access indicator, watchdog output and an input switch for resetting the card.

Speaker

The PCM-5862E/5862EL can drive an 8 Ω speaker at 0.5 watts. Ensure that alternatives to this specification do not overload the card.

LED interface

The front panel LED indicator for hard disk access is an active low signal (24 mA sink rate).

Watchdog output

When PCM-5862E/5862EL watchdog timer times out, the front panel pin 6 will output an active low pulse signal (25mA sink rate for 1 second).

Reset switch

If you install a reset switch, it should be an open single pole switch. Momentarily pressing the switch will activate a reset. The switch should be rated for 10 mA, 5 V.

If you need to make your own cable, you can find the pin assignments for the board's connector in Appendix C.

Power connectors (CN6, CN10, CN14)

Peripheral power connector, -5V, -12V (CN10)

Supplies secondary power to devices that require -5 V and -12 V.

Main power connector, +5V, +12V (CN14)

Supplies main power to the PCM-5862E/5862EL (+5 V) and devices that require +12 V.

Fan power supply connector (CN6)

Provides power supply to optional CPU cooling fan. Only present when +5 V and +12 V power is supplied to the board.

ATX Power Control Connector (CON1, CON2)

ATX feature connector (CON1) and soft power switch connector (CON2)

The PCM-5862E/5862EL can support an advanced soft power switch function if an ATX power supply is used. To enable the soft power switch function:

1. Take the specially designed ATX-to-PS/2 power cable (PCM-5862E/5862EL option item)
2. Connect the 3-pin plug of the cable to CON1 (ATX feature connector).
3. Connect the power on/off button to CON2. (A momentary type of button should be used.)

Important: Be sure that the ATX power supply can take at least a 10 mA load on the 5 V standby lead (5VSB). If not, you may have difficulty powering on your system.

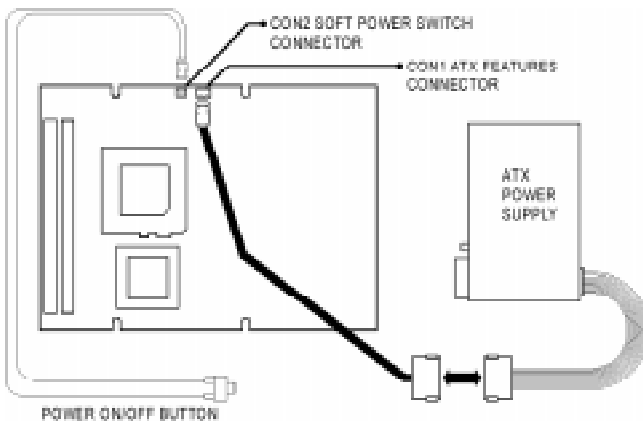

Wiring for ATX soft power switch function

IR connector (CN12)

This connector supports the optional wireless infrared transmitting and receiving module. This module mounts on the system case. You must configure the setting through BIOS setup.

Audio interfaces (CN8, CN13)

The PCM-5862E/5862EL is equipped with a high quality audio interface, which provides 16-bit CD-quality recording and playback as well as OPL3 compatible FM music. It is supported by all major operating systems and is 100% Sound Blaster Pro compatible.

Audio connector (CN13)

The PCM-5862E/5862EL provides all major audio signals on a 16-pin flat-cable connector, CN13. These audio signals includes Microphone in (mono), Line in (stereo), Line out (stereo), Speaker out (stereo). You will need an adapter cable if you use traditional telephone jack connectors for these audio signals.



CD audio input connector (CN8)

All CD-ROM drives can provide analog audio signal output when used as a music CD player. The CN8 on PCM-5862E/5862EL is a connector to input CD audio signal into the audio controller. The audio cable of your CD-ROM drive will be used to connect to CN8.

Audio power source setting (J16)

The PCM-5862E/5862EL is designed to work with a single +5V power supply. The audio interface can also function normally under single +5V power supply, but most audio controllers require an independent power source generated from a +12V power. The independent power source avoids the noise from the other digital circuits. The PCM-5862E/5862EL's audio interface can also accept +12V power to provide improved quality audio. This is done via J16.

Audio power source setting

	*+5 V	+12 V
	1 2 3	1 2 3
J16		

* default setting

Configuration of the audio interface is done completely via the software utility. You don't have to set any jumpers. Refer to Chapter 6 for audio setup details.

COM-port connector (CN16)

The PCM-5862E/5862EL provides four serial ports (COM1, 3, 4: RS-232; COM2: RS-232/422/485) in one COM port connector. The COM port connector is a 40-pin, dual-in-line, male header and provides connections for serial devices (a mouse, etc.) or a communication network. You can find the pin assignments for the COM port connector in Appendix C.

COM2 RS-232/422/485 setting (J14, J15)

COM2 can be configured to operate in RS-232, RS-422, or RS-485 mode. This is done via J14 and J15.

COM2 RS-232/422/485 setting

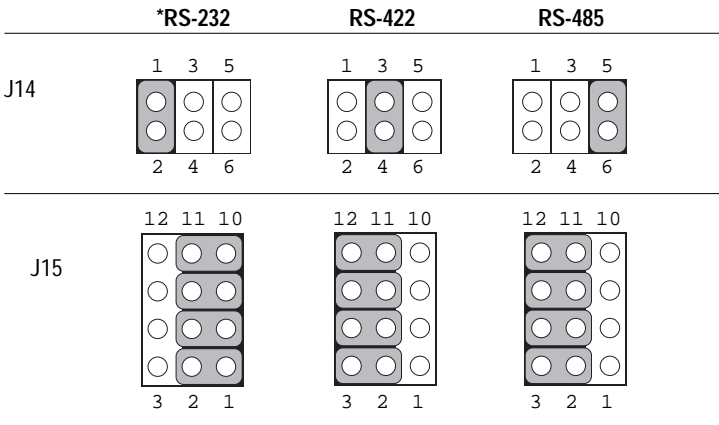

* default setting

The IRQ and the address range for COM1, 2, 3, 4 are fixed. However, if you wish to disable the port or change these parameters later you can do this in the system BIOS setup. The table below shows the settings for the PCM-5862E/5862EL's serial ports.

PCM-5862E/5862EL serial port default settings

Port	Address Range	Interrupt
COM1	3F8-3FF	IRQ4
COM2	2F8-2FF	IRQ3
COM3	3E8-3EF	IRQ10
COM4	2E8-2EF	IRQ5

COM3/COM4 RI pin setting (J11, J12)

The COM3 and COM4 can supply +5V or +12V power to the serial devices via RI pin of the COM port connector. The outputs of COM3, COM4 RI pins are selected by setting J11, J12.

COM3 RI pin setting

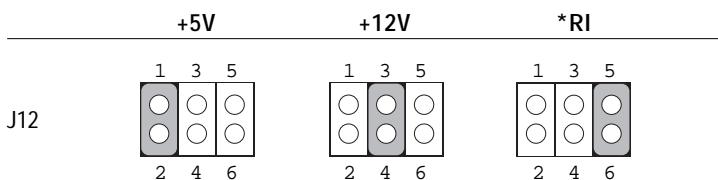

COM4 RI pin setting

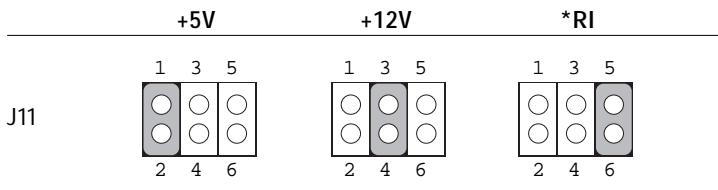

*** default setting**

VGA interface connections

The PCM-5862E/5862EL's PCI SVGA interface can drive conventional CRT displays and is capable of driving a wide range of flat panel displays, including electroluminescent (EL), gas plasma, passive LCD and active LCD displays. The board has two connectors to support these displays, one for standard CRT VGA monitors and one for flat panel displays.

CRT display connector (CN1)

CN1 is a 16-pin, dual-in-line header used for conventional CRT displays. A simple one-to-one adapter can be used to match CN1 to a standard 15-pin D-SUB connector commonly used for VGA.

Pin assignments for CRT display connector CN1 are detailed in Appendix C.

Flat panel display connector (CN2)

CN2 consists of a 44-pin, dual-in-line header. Power supply (+12V) present on CN2 depends on the supply connected to the board. Ensure that both CN10 and CN14 are connected for ± 12 V power supply.

The PCM-5862E/5862EL provides a bias control signal on CN2 that can be used to control the LCD bias voltage. It is recommended that the LCD bias voltage not be applied to the panel until the logic supply voltage (+5V or +3.3V) and panel video signals are stable. Under normal operation, the control signal (ENAVEE) is active high. When the PCM-5862E/5862EL's power is applied, the control signal is low until just after the relevant flat panel signals are present.

LCD power setting (J10)

The PCM-5862E/5862EL's PCI SVGA interface supports 5V and 3.3V LCD displays. By changing the setting of J10, you can select the panel video signal level to be 5V or 3.3V.

LCD power setting

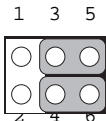
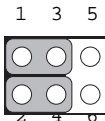
	*5 V	3.3 V
J10		

* default setting

Configuration of the VGA interface is done completely via the software utility. You don't have to set any jumpers. Refer to Chapter 3 for software setup details.

Refer to Chapter 3 for details on connecting the five standard LCD's: Sharp LM64183P, LM64P89, Toshiba LTM10C042, Sharp 64C142, and Planar EL Display.

Ethernet configuration

The PCM-5862E/5862EL is equipped with a high performance 32-bit PCI-bus Ethernet interface which is fully compliant with IEEE 802.3U 10/100Mbps CSMA/CD standards. It is supported by all major network operating systems and is 100% Novell NE-2000 compatible.

The medium type can be configured via the RSET8029.EXE program included on the utility disk. (See Chapter 3 for detailed information.)

100BASE-T connector (CN11)

100BASE-T connects to the PCM-5862E/5862EL via an adapter cable to a 10-pin polarized header (CN11). For 10BASE-T RJ-45 operation, an adapter cable converting CN11 into a standard RJ-45 jack is required.

Network boot

The Network Boot feature can be utilized by incorporating the Boot ROM image files for the appropriate network operating system. The Boot ROM BIOS files are on the included utility disk.

Watchdog timer configuration

An on-board watchdog timer reduces the chance of disruptions which EMP (electro-magnetic pulse) interference can cause. This is an invaluable protective device for standalone or unmanned applications. Setup involves one jumper and running the control software (refer to Appendix A).

Watchdog timer action (J13)

When the watchdog timer activates (CPU processing has come to a halt), it can reset the system or generate an interrupt on IRQ15. This can be set via setting J13 as shown below:

Watchdog timer action

*System reset

IRQ15

J13



1
2
3



1
2
3

* default setting

USB connectors (CN4, CN5)

The PCM-5862E/5862EL board provides two USB (Universal Serial Bus) interfaces which gives complete plug and play, hot attach/detach for up to 127 external devices. The USB interfaces comply with USB specification rev. 1.0 and are fuse protected.

The USB interfaces are accessed through two 4-pin flat-cable connectors, CN4 and CN5. You will need an adapter cable if you use a standard USB connector. The adapter cable has a 4-pin connector on one end and an USB connector on the other.

The USB interfaces can be disabled in the system BIOS setup.

Software Configuration

This chapter details the software configuration information. It shows you how to configure the card to match your application requirements. AWARD System BIOS is covered in Chapter 4.

Sections include:

- Introduction
- Connections for four standard LCDs
- Ethernet interface configuration

Introduction

The PCM-5862E/5862EL system BIOS and custom drivers are located in a 128 Kbyte, 32-pin (JEDEC spec.) Flash ROM device, designated U19. A single Flash chip holds the system BIOS, VGA BIOS, and network Boot ROM image. The display can be configured via CMOS settings. This method minimizes the number of chips and difficulty of configuration. To set different types of LCD panels please choose “panel type” from the “integrated peripherals” menu in CMOS setup.

Connections for five standard LCDs

Connections to Sharp LM64183P, LM64P89 (640 x 480 DSTN MONO LCD)

LM64183/64P89		PCM-5862E/5862EL CN2	
Pin	Pin name	Pin	Pin name
CN1-1	S	36	FLM
CN1-2	CP1	38	LP
CN1-3	CP2	35	SHFCLK
CN1-4	DISP	5	+5 V
CN1-5	VDD	6	+5 V
CN1-6	VSS	3	GND
CN1-7	VEE	-	external power*
CN1-8	DU0	12	P3
CN1-9	DU1	11	P2
CN1-10	DU2	10	P1
CN1-11	DU3	9	P0
CN1-12	DL0	16	P7
CN1-13	DL1	15	P6
CN1-14	DL2	14	P5
CN1-15	DL3	13	P4

*LM64183P -17V
LM64P89 -20V

Connections to PLANAR EL (640 x 480 AD4 EL)

PLANAR 640 x 480 AD4		PCM-5862E/5862EL CN2	
Pin	Pin name	Pin	Pin name
1	GND	3	GND
2	D0	21	P12
3	GND	3	GND
4	D1	22	P13
5	GND	3	GND
6	D2	23	P14
7	NC	—	—
8	D3	24	P15
9	NC	—	—
10	D4	17	P8
11	NC	—	—
12	D5	18	P9
13	NC	—	—
14	D6	19	P10
15	GND	4	GND
16	D7	20	P11
17	GND	4	GND
18	VCLK	42	ASHFCLK
19	GND	4	GND
20	/BLANK	—	—
21	GND	8	GND
22	HS	37	M
23	NC	—	—
24	VS	36	FLM
25	NC	—	—
26	SELFST	39	GND
27	COLMAP	39	GND
28	ENABLE	—	—
29	RESERVED	—	—
30	/LOWPOW	—	—
31,32	NC	—	—
33	RESERVED	—	—
34	NC	—	—

Connections to Toshiba LTM10C042 (640 x 480 TFT Color LCD)

LTM10C042		PCM-5862E/5862EL CN2	
Pin	Pin name	Pin	Pin name
1	GND	3	GND
2	CLK	35	SHFCLK
3	GND	4	GND
4	R0	27	P18
5	R1	28	P19
6	R2	29	P20
7	GND	8	GND
8	R3	30	P21
9	R4	31	P22
10	R5	32	P23
11	GND	33	GND
12	G0	19	P10
13	G1	20	P11
14	G2	21	P12
15	GND	33	GND
16	G3	22	P13
17	G4	23	P14
18	G5	24	P15
19	GND	34	GND
20	ENAB	37	M
21	GND	34	GND
22	B0	11	P2
23	B1	12	P3
24	B2	13	P4
25	GND	39	GND
26	B3	14	P5
27	B4	15	P6
28	B5	16	P7
29	GND	39	GND
30	VDD	5	+5V
31,32	VDD	6	+5V

Connections to Sharp LM64C142 (640 x 480 DSTN Color LCD)

LM64C142		PCM-5862E/5862EL CN2	
Pin	Pin name	Pin	Pin name
CN1-1	YD	36	FLM
CN1-2	LP	38	LP
CN1-3	XCX	35	SHFCLK
CN1-4	DISP	5	+5V
CN1-5	VDD	6	+5V
CN1-6	VSS	3	GND
CN1-7	VEE	—	+27*
CN1-8	DU0	20	P11
CN1-9	DU1	19	P10
CN1-10	DU2	18	P9
CN1-11	DU3	17	P8
CN1-12	DU4	12	P3
CN1-13	DU5	11	P2
CN1-14	DU6	10	P1
CN1-15	DU7	9	P0
CN2-1	VSS	4	GND
CN2-2	DL0	24	P15
CN2-3	DL1	23	P14
CN2-4	DL2	22	P13
CN2-5	DL3	21	P12
CN2-6	DL4	16	P7
CN2-7	DL5	15	P6
CN2-8	DL6	14	P5
CN2-9	DL7	13	P4
CN2-10	VSS	8	GND

Connections to Toshiba LTM12C275A (800 x 600 TFT Color LCD)

LTM12C275A		PCM-5862E/5862EL CN2	
Pin	Pin name	Pin	Pin name
1	GND	3	GND
2	NCLK	35	SHFCLK
3	NC	-	NC
4	NC	-	NC
5	GND	4	GND
6	R0	27	P18
7	R1	28	P19
8	R2	29	P20
9	R3	30	P21
10	R4	31	P22
11	R5	32	P23
12	GND	8	GND
13	G0	19	P10
14	G1	20	P11
15	G2	21	P12
16	G3	22	P13
17	G4	23	P14
18	G5	24	P15
19	GND	33	GND
20	B0	11	P2
21	B1	12	P3
22	B2	13	P4
23	B3	14	P5
24	B4	15	P6
25	B5	16	P7
26	ENAB	37	M/DE
27	GND	34	GND
28	VCC	5	+5 V
29	VCC	6	+5 V
30	GND	39	GND

Ethernet software configuration

The PCM-5862E/5862EL's on-board Ethernet interface supports all major network operating systems. To configure the medium type, to view the current configuration, or to run diagnostics, do the following:

1. Power the PCM-5862E/5862EL on. Ensure that the RSET8139.EXE file is located in the working drive.
2. At the prompt type RSET8139.EXE and press <Enter>. The Ethernet configuration program will then be displayed.
3. This simple screen shows all the available options for the Ethernet interface. Just highlight the option you wish to change by using the Up and Down keys. To change a selected item, press <Enter>, and a screen will appear with the available options. Highlight your option and press <Enter>. Each highlighted option has a helpful message guide displayed at the bottom of the screen for additional information.
4. After you have made your selections and are sure this is the configuration you want, press ESC. A prompt will appear asking if you want to save the configuration. Press Y if you want to save.

The Ethernet Setup Menu also offers three very useful diagnostic functions. These are:

1. Run EEPROM test
2. Run Diagnostics on Board
3. Run Diagnostics on Network

Each option has its own display screen that shows the format and result of any diagnostic tests undertaken.

System test and initialization

These routines test and initialize board hardware. If the routines encounter an error during the tests, you will either hear a few short beeps or see an error message on the screen. There are two kinds of errors: fatal and non-fatal. The system can usually continue the boot up sequence with non-fatal errors. Non-fatal error messages usually appear on the screen along with the following instructions:

```
press <F1> to RESUME
```

Write down the message and press the F1 key to continue the bootup sequence.

System configuration verification

These routines check the current system configuration against the values stored in the board's CMOS memory. If they don't match, the program outputs an error message. You will then need to run the BIOS setup program to set the configuration information in memory.

There are three situations in which you will need to change the CMOS settings:

1. You are starting your system for the first time
2. You have changed the hardware attached to your system
3. The CMOS memory has lost power and the configuration information has been erased.

The PCM-5862E/5862EL's CMOS memory has an integral lithium battery backup. The battery backup should last ten years in normal service, but when it finally runs down, you will need to replace the complete unit.

Award BIOS Setup

This chapter describes how to set BIOS configuration data.

System test and initialization

These routines test and initialize board hardware. If the routines encounter an error during the tests, you will either hear a few short beeps or see an error message on the screen. There are two kinds of errors: fatal and non-fatal. The system can usually continue the boot up sequence with non-fatal errors. Non-fatal error messages usually appear on the screen along with the following instructions:

```
press <F1> to RESUME
```

Write down the message and press the F1 key to continue the bootup sequence.

System configuration verification

These routines check the current system configuration against the values stored in the board's CMOS memory. If they don't match, the program outputs an error message. You will then need to run the BIOS setup program to set the configuration information in memory.

There are three situations in which you will need to change the CMOS settings:

1. You are starting your system for the first time
2. You have changed the hardware attached to your system
3. The CMOS memory has lost power and the configuration information has been erased.

The PCM-5862E/5862EL's CMOS memory has an integral lithium battery backup. The battery backup should last ten years in normal service, but when it finally runs down, you will need to replace the complete unit.

AWARD BIOS setup

Award's BIOS ROM has a built-in Setup program that allows users to modify the basic system configuration. This type of information is stored in battery-backed CMOS RAM so that it retains the Setup information when the power is turned off.

Entering setup

Power on the computer and press immediately. This will allow you to enter Setup.

```
ROM PCI/ISA BIOS (ZASIHAKA)
CMOS SETUP UTILITY
AWARD SOFTWARE, INC.
```

STANDARD CMOS SETUP	INTEGRATED PERIPHERALS
BIOS FEATURES SETUP	PASSWORD SETTING
CHIPSET FEATURES SETUP	IDE HDD AUTO DETECTION
POWER MANAGEMENT SETUP	SAVE & EXIT SETUP
PNP/PCI CONFIGURATION	EXIT WITHOUT SAVING
LOAD BIOS DEFAULTS	
LOAD SETUP DEFAULTS	
Esc : Quit	↑ ↓ → ← : Select Item
F10 : Save & Exit Setup	(Shift)F2 : Change Color

Setup program initial screen

Standard CMOS setup

When you choose the STANDARD CMOS SETUP option from the INITIAL SETUP SCREEN menu, the screen shown below is displayed. This standard Setup Menu allows users to configure system components such as date, time, hard disk drive, floppy drive and display. Once a field is highlighted, on-line help information is displayed in the left bottom of the Menu screen.

```
ROM PCI/ISA BIOS (ZASIMAKA)
STANDARD CMOS SETUP
AWARD SOFTWARE, INC.

Date (mm:dd:yy) : Tue, Aug 18 1998
Time (hh:mm:ss) : 9 : 45 : 18

          CYLS.  HEADS  PRECOMP  LANISOME  SECTORS  MODE
Drive C : Auto  ( 0Mb)  0      0      0      0      0  AUTO
Drive D : None  ( 0Mb)  0      0      0      0      0  -----

Drive A : 1.44M, 3.5 in.
Drive B : NONE
Floppy 3 Mode Support : Disabled

Video : EGA/VGA

Halt On : All,But Keyboard

          Base Memory:  640K
          Extended Memory:  0K
          Other Memory:  384K
          -----
          Total Memory: 1024K

ESC : Quit          F4/F5/F6 : Select Item      F10/F11/+/- : Modify
F1 : Help          (Shift)F2 : Change Color
```

CMOS setup screen

BIOS features setup

By choosing the BIOS FEATURES SETUP option from the INITIAL SETUP SCREEN menu, the screen below is displayed. This sample screen contains the manufacturer's default values for the PCM-5862E/5862EL.

ROM PCI/ISA BIOS (2A51H8A8)
BIOS FEATURES SETUP
AWARD SOFTWARE, INC.

Virus Warning	: Disabled	Video BIOS Shadow	= Enabled
CPU Internal Cache	: Enabled	C8000-CBFFF Shadow	= Disabled
External Cache	: Enabled	CC000-CFFFF Shadow	= Disabled
Quick Power On Self Test	: Enabled	D0000-D3FFF Shadow	= Disabled
Boot Sequence	: C,A	D4000-D7FFF Shadow	= Disabled
Swap Floppy Drive	: Disabled	D8000-DBFFF Shadow	= Disabled
Boot Up Floppy Seek	: Enabled	DC000-DEFFF Shadow	= Disabled
Boot Up NumLock Status	: On		
Boot Up System Speed	: High		
Gate A20 Option	: Fast		
Typeomatic Rate Setting	: Disabled		
Typeomatic Rate (Chars/sec)	: 6		
Typeomatic Delay (Msec)	: 250		
Security Option	: Setup		
PCI/VGA Palette Snoop	: Disabled		
OS Select For DRAM > 64MB	: Mem-OS2	ESC : Quit	F4+ : Select Item
		F1 : Help	F5/F6/+/- : Modify
		F5 : Old Values (Shift)F2 : Color	
		F6 : Load BIOS Defaults	
		F7 : Load Setup Defaults	

BIOS features setup

CHIPSET features setup

By choosing the CHIPSET FEATURES SETUP option from the INITIAL SETUP SCREEN menu, the screen below is displayed. This sample screen contains the manufacturer's default values for the PCM-5862E/5862EL.

```
ROM PCI/ISA BIOS (2A51HAKA)
CHIPSET FEATURES SETUP
AWARD SOFTWARE, INC.
```

Auto Configuration : Enabled	Memory Hole at 15M-16M : Disabled
L2 (WB) Tag Bit Length : 8bits	Linear Mode SRAM Support: Disabled
SRAM Back-to-Back : Enabled	
NR# Enable : Enabled	
DRAM RD Leadoff Time : 5T	
Refresh Cycle Time (ns) : 62.4	
RAS Pulse Width Refresh : 5T	
RAS Precharge Time : 4T	
RAS to CAS Delay : 4T	
CAS# Pulse Width (F0) : 2T	
CAS# Pulse Width (ED0) : 1T	
RAMP# Assertion Timing : Normal	
EDO Back-to-Back Timing : 3T	
Read Prefetch Memory RD : Enabled	
CPU to PCI Post Write : 3T	
CPU to PCI Burst Mem. WR: Disabled	ESC : Quit ↑↓←→ : Select Item
ISA Bus Clock Frequency : FCICLK/4	F1 : Help F0/FD/+/ - : Modify
System BIOS Cacheable : Enabled	F5 : Old Values (Shift)F2 : Color
Video BIOS Cacheable : Enabled	F6 : Load BIOS Defaults
	F7 : Load Setup Defaults

CHIPSET features setup

Power management setup

By choosing the POWER MANAGEMENT SETUP option from the INITIAL SETUP SCREEN menu, the screen below is displayed. This sample screen contains the manufacturer's default values for the PCM-5862E/5862EL.

```
ROM PCI/ISA BIOS (2AS1HAKA)
POWER MANAGEMENT SETUP
AWARD SOFTWARE, INC.
```

Power Management : Disable	IRQ5 (COM 2) : Enabled
EM Control by APM : Yes	IRQ4 (COM 1) : Enabled
Video Off Option : Susp.Stby -> Off	IRQ5 (COM 4) : Enabled
Video Off Method : DMS Supported	IRQ6 (Floppy Disk) : Enabled
Switch Function : Break/Make	IRQ7 (LPT 1) : Enabled
Doze Speed (div by) : 2	IRQ8 (RTC Alarm) : Disabled
Stby Speed(div by) : 3	IRQ9 (IRQ2 Redir) : Enabled
MODEM Use IRQ : 3	IRQ10 (COM 3) : Enabled
	IRQ11 (Reserved) : Enabled
** EM Timers **	IRQ12 (PS/2 Mouse) : Enabled
HDD Off After : Disable	IRQ13 (Coprocesor) : Enabled
Doze Mode : Disable	IRQ14 (Hard Disk) : Enabled
Standby Mode : Disable	IRQ15 (Reserved) : Enabled
Suspend Mode : Disable	
** EM Events **	ESC : Quit F4+ : Select Item
COM Ports Activity : Enabled	F1 : Help BU/PD/+/- : Modify
LPT Ports Activity : Enabled	F3 : Old Values (Shift+F2) : Color
HDD ports Activity : Enabled	F6 : Load Bios Defaults
VGA Activity : Disabled	F7 : Load Setup Defaults

Power management setup

PnP/PCI Configuration

By choosing the PnP/PCI CONFIGURATION option from the Initial Setup Screen menu, the screen below is displayed. This sample screen contains the manufacturer's default values for the PCM-5862E/5862EL.

ROM PCI/ISA BIOS (ZASIHAKA)
PnP/PCI CONFIGURATION
AWARD SOFTWARE, INC.

Resources Controlled By : Manual Reset Configuration Data : Disabled	PCI IRQ Activated By : Level PCI IDE 2nd Channel : Enabled PCI IDE IRQ Map To : PCI-AUTO Primary IDE INT# : A Secondary IDE INT# : B
IRQ-3 assigned to : Legacy ISA IRQ-4 assigned to : Legacy ISA IRQ-5 assigned to : PCI/ISA PnP IRQ-7 assigned to : Legacy ISA IRQ-9 assigned to : PCI/ISA PnP IRQ-10 assigned to : PCI/ISA PnP IRQ-11 assigned to : PCI/ISA PnP IRQ-12 assigned to : PCI/ISA PnP IRQ-14 assigned to : Legacy ISA IRQ-15 assigned to : Legacy ISA DMA-0 assigned to : PCI/ISA PnP DMA-1 assigned to : PCI/ISA PnP DMA-3 assigned to : PCI/ISA PnP DMA-5 assigned to : PCI/ISA PnP DMA-6 assigned to : PCI/ISA PnP DMA-7 assigned to : PCI/ISA PnP	ESC : Quit +Ins : Select Item F1 : Help F0/F10/+/- : Modify F5 : Old Values (Shift/F2 : Color F6 : Load BIOS Defaults F7 : Load Setup Defaults

PnP/PCI Configuration

Integrated Peripherals

By choosing the INTEGRATED PERIPHERALS option from the INITIAL SETUP SCREEN menu, the screen below is displayed. This sample screen contains the manufacturer's default values for the PCM-5862E/5862EL.

ROM PCI/ISA BIOS (ZASINAKA)
INTEGRATED PERIPHERALS
AWARD SOFTWARE, INC.

Internal PCI/IDE : Enabled	PS/2 mouse function : Enabled
IDE Primary Master PIO : Auto	USB Controller : Disabled
IDE Primary Slave PIO : Auto	
IDE Burst Mode : Disabled	Ethernet Boot Rom : Disabled
IDE Data Post Post Write: Enabled	Panel Type : Ignore Int15 Hook
IDE HDD Block Mode : Enabled	
Onboard FDD Controller : Enabled	
Onboard Serial Port 1 : 3F8/IRQ4	
Onboard Serial Port 2 : 2F8/IRQ3	
Onboard Serial Port 3 : 3E8/IRQ10	
Onboard Serial Port 4 : 2E8/IRQ5	
UART 2 Mode : Standard	
Onboard Parallel Port : 378/IRQ7	ESC : Quit F4/F5 : Select Item
Onboard Parallel Mode : ECP/EPP	F1 : Help F6/F7/F8/+/- : Modify
ECP Mode Use DMA : 3	F5 : Old Values (Shift)F2 : Color
Parallel Port EPP Type : EPP1.9	F6 : Load BIOS Defaults
	F7 : Load Setup Defaults

Integrated Peripherals

Load BIOS defaults

LOAD BIOS DEFAULTS loads the default system values directly from ROM. If the stored record created by the Setup program becomes corrupted (and therefore unusable), these defaults will load automatically when you turn the PCM-5862E/5862EL on.

```
ROM PCI/ISA BIOS (2A51B8KA)
CMOS SETUP UTILITY
AMARD SOFTWARE, INC.
```

STANDARD CMOS SETUP	INTEGRATED PERIPHERALS
BIOS FEATURES SETUP	PASSWORD SETTING
CHIPSET FEATURES SETUP	IDE HDG AUTO DETECTION
POWER MANAGEMENT SETUP	SAVE & EXIT SETUP
MWD/PCI CONFIGURA	SAVING
LOAD BIOS DEFAULT	Load BIOS Defaults (Y/N)? N
LOAD SETUP DEFAULTS	
Esc : Quit	↑ ↓ → ← : Select Item
F10 : Save & Exit Setup	(Shift)F2 : Change Color

Load BIOS defaults screen

Change Password

To change the password, choose the PASSWORD SETTING option from the Setup main menu and press <Enter>.

1. If the CMOS is bad or this option has never been used, a default password is stored in the ROM. The screen will display the following messages:

Enter Password:

Press <Enter>.

2. If the CMOS is good or this option has been used to change the default password, the user is asked for the password stored in the CMOS. The screen will display the following message:

Confirm Password:

Enter the current password and press <Enter>.

3. After pressing <Enter> (ROM password) or the current password (user-defined), you can change the password stored in the CMOS. The password can be at most eight (8) characters long.

Remember - to enable this feature, you must first select either Setup or System in the BIOS FEATURES SETUP.

Auto detect hard disk

The IDE HDD AUTO DETECTION utility can automatically detect the IDE hard disk installed in your system. You can use it to self-detect and/or correct the hard disk type configuration.

```
ROM PCI/ISA BIOS (2A51HAKA)
CMOS SETUP UTILITY
AMARD SOFTWARE, INC.

HARD DISK TYPE  SIZE  CYLS.  HEADS  PRECOMP  LANDE  SECTORS  MODE
Drive C        : (MB) 790   15    65535  789    57

SELECT SECONDARY SLAVE OPTION (N=skip): N

ESC = SKIP
```

IDE HDD auto detection screen

Save & exit setup

If you select this option and press <Enter>, the values entered in the setup utilities will be recorded in the chipset's CMOS memory. The microprocessor will check this every time you turn your system on and compare this to what it finds as it checks the system. This record is required for the system to operate.

Exit without saving

Selecting this option and pressing <Enter> lets you exit the Setup program without recording any new values or changing old ones.

CHAPTER 5

PCI SVGA Setup

The PCM-5862E/5862EL features an on-board PCI flat panel/VGA interface. This chapter provides instructions for installing and operating the software drivers on the included display driver diskette.

Before you begin

To facilitate the installation of the enhanced display device drivers and utility software, you should read the instructions in this chapter carefully before you attempt installation. The enhanced display drivers for the PCM-5862E/5862EL board are located on the software installation diskette. You must install the drivers and utility software by using the supplied SETUP program for DOS drivers

Note: *The files on the software installation diskette are compressed. Do not attempt to install the drivers by copying the files manually. You must use the supplied SETUP program to install the drivers.*

Before you begin, it is important to note that most display drivers need to have the relevant software application already installed in the system prior to installing the enhanced display drivers. In addition, many of the installation procedures assume that you are familiar with both the relevant software applications and operating system commands. Review the relevant operating system commands and the pertinent sections of your application software's user's manual before performing the installation.

Installation

Disk 1: Windows 3.1, Windows 95, and Windows NT drivers

Disk 2: OS/2 drivers

Simultaneous display mode

The 65550 VGA BIOS supports monochrome LCD, EL, color TFT and STN LCD flat panel displays. It also supports interlaced and non-interlaced analog monitors (VGA color and VGA monochrome) in high-resolution modes while maintaining complete IBM VGA compatibility. Digital monitors (i.e. MDA, CGA, and EGA) are NOT supported. Multiple frequency (multisync) monitors are supported as analog monitors.

Both CRT and panel displays can be used simultaneously. The PCM-5863E/5862EL can be set in one of three configurations: on a CRT, on a flat panel display, or on both simultaneously. The system is initially set to simultaneous display mode. In the utility diskette, there are three .COM files that can be used to select the display. Simply type the filename at the DOS prompt:

CT.COM Enables CRT display only

FP.COM Enables panel display only

SM.COM Enables both displays at the same time.

Sleep mode

The display driver diskette contains two files that support sleep mode. Simply type the filename at the DOS prompt:

ON.COM switches to normal display mode.

OFF.COM switches to sleep mode.

Driver installation

Necessary prerequisites

The instructions in this manual assume that you understand elementary concepts of MS-DOS and the IBM Personal Computer. Before you attempt to install any driver or utility you should: know how to copy files from a floppy disk to a directory on the hard disk, understand the MS-DOS directory structure, and know how to format a floppy disk. If you are uncertain about any of these concepts, please refer to the DOS or Windows user reference guides for more information before you proceed with the installation.

Before you begin

Before you begin installing software drivers, you should make a backup copy of the display driver diskette and store the original in a safe place. The display driver diskette contains drivers for several versions of certain applications. You must install the correct version in order for the driver to work properly so make sure you know which version of the application you have.

Windows setup

These drivers are designed to work with Microsoft Windows 3.1. You may install these drivers through Windows or in DOS.

Step 1: Install Windows as you normally would for a VGA display. Run Windows to make sure that it is working correctly.

Step 2: Place the display driver diskette in drive A. In Windows Program Manager, choose **File** from the Options Menu. Then from the pull-down menu, choose **Run . . .** At the command line prompt, type **A:\SETUP**. Press the <ENTER> key or click **OK** to begin the installation. At this point, the setup program locates the directory where Windows is installed. For proper operation, the drivers must be installed in the Windows subdirectory. Press <ENTER> to complete the installation. Once completed, the Display Driver Control Panel appears on the screen. This Control Panel allows you to select and load the installed drivers.

Another method of installing these drivers is through the File Manager. Click on **Drive A:**. Then double-click on **SETUP.EXE** to begin installation.

Changing Display Drivers in Windows

To change display drivers in Windows, select the **Windows Setup** icon from the Main window. You will be shown the current setup configuration. Select **Change System Settings** from the Option menu. Click on the arrow at the end of the Display line. You will be shown a list of display drivers. Click on the driver you want. Then click on the **OK** button. Follow the directions to complete the setup.

Changing Color Schemes

After you change display drivers, you may notice that the color scheme used by Windows looks strange. This is because different drivers have different default colors. To change the color scheme, select the **Control Panel** from the Main window. Select the **Color** icon. You will be shown the current color scheme. Choose a new color scheme and click the **OK** button.

DOS Setup

Step 1: Install Windows as you normally would for a VGA display. Run Windows to make sure that it is working correctly. Then exit Windows.

Step 2: Place the display driver diskette in drive A. Type **A:** <ENTER> to make this the default drive. Type **SETUP** <ENTER> to run the driver SETUP program. Press any key to get to the applications list. Using the arrow keys, select **Windows Version 3.1** and press the <ENTER> key. Press the <ENTER> key to select **All Resolutions**, and then press <END> to begin the installation. At this point, you will be asked for the path to your Windows System directory (default C:\WINDOWS). When the installation is complete, press any key to continue. Press <ESC> followed by Y to exit to DOS.

Step 3: Change to the directory where you installed Windows (usually C:\WINDOWS).

Step 4: Type **SETUP** <ENTER> to run the Windows Setup program. It will show the current Windows configuration. Use the up arrow key to move to the Display line and press <ENTER>. A list of display drivers will be shown. Use the arrow keys to select one of the drivers starting with an asterisk (*) and press <ENTER>.

Step 5: Follow the directions on the screen to complete the setup. In most cases, you may press <ENTER> to accept the suggested option. When Setup is done, it will return to DOS. Type **WIN** <ENTER> to start Windows with the new display driver.

Changing Display Drivers in DOS

To change display drivers from DOS, change to the Windows directory and run Setup, repeating steps 4 and 5 from the previous page. Besides the special display drivers marked by an asterisk (*), you should be able to use the following standard drivers:

VGA	640x480, 16 colors
Super VGA	800x600, 16 colors

Panning Drivers

Special panning drivers are provided to allow high-resolution modes to be displayed on a flat panel or CRT. These drivers will show a section of a larger screen and will automatically pan, or scroll, the screen horizontally and vertically when the mouse reaches the edge of the display.

Linear Acceleration Drivers

A special high-performance linear acceleration driver is provided for 256-color modes. This driver may require special hardware and may not be supported on all systems. It is only available for Windows 3.1.

Windows 95 Drivers Setup Procedure

1. Boot system with VGA or SuperVGA driver.
2. Select properties from a menu after right button press.
3. Select display.
4. Select Change Display.
5. Select Change Monitor.
6. Select Change Adapter.
7. Select Have Disk.

Windows NT Drivers Setup Procedure

Step 1

1. Install Windows NT as you normally would for a VGA display.
2. First click the Start button, choose Settings and click on Control Panel.
3. Choose the Display icon and click on the icon.
4. In the Display Properties window, click on the Settings tab.
5. Click on Change Display Type. In the Change Display Type window, click on the Change button under Adapter Type. This will bring up the Select Device window.

Step 2

1. In the Select Device window, click on the Other button. Enter source directory where the Windows NT driver files are located.
2. Press <ENTER> and the name of the Chips and Technologies Video Accelerator driver will appear at the end of Models list box. Scroll to the end of the list box and double click on the driver.
3. Once the installation is complete, the system must be shut down and restarted.

Step 3

1. Upon restarting your computer, select the desired display settings from the Display property dialog box.
2. Click on Test to test the newly selected graphics mode. A color test screen should appear, followed by the Testing Mode window.
3. Click on Yes to continue. The Display Settings Change window will appear.
4. Click on Restart Now for the new settings to take effect.

OS/2 Drivers Setup Procedure

Preliminary Steps

The following steps must be performed before you install the 65550/554 display driver:

1. OS/2 DOS Support must be installed.
2. If you previously installed SVGA support, you must reset the system to VGA mode. VGA is the default video mode enabled when OS/2 is installed.

To restore VGA mode, use Selective Install and select VGA for Primary Display. For more information on this procedure, see the section on Changing Display Adapter Support in the OS/2 User's Guide.

Installing from Diskette

To install this driver, do the following steps:

1. Open an OS/2 full screen or windowed session.
2. Place the 65550 PCI Display Driver Diskette in drive A.
3. At the OS/2 command prompt, type the following commands to copy the files to the OS/2 drive:

Type:

```
A: <ENTER> to make this the default drive.
```

```
SETUP A: C: <ENTER>
```

where A: is the floppy disk drive and
C: is the hard disk partition containing \OS2

When the Setup Program is completed, you will need to perform a shutdown and then restart the system in order for changes to take effect.

A log of the information output during the install can be found in
<root>:\OS2\INSTALL\DISPLAY.LOG

4. After restarting the system, perform the following steps:

- 1). Open the OS/2 System folder.
- 2). Open the System Setup folder.
- 3). Open the Display Driver Install Object

This step will execute the Display Driver Installation (DSPINSTL) utility program to finish installation of the new drivers.

- 4). When the Display Driver Install window appears, select Primary Display and then select OK.
- 5). When The Primary Display Driver List window appears, select "Chips and Technologies 65550/554" from the list of adapter types, then select OK to install the video driver.
- 6). When the installation is complete, you will need to shutdown and then restart the system for the changes to take effect. Make sure to remove the install diskette before restarting the system.

When the system has restarted, the display driver will be initialized for 640x480x256 Color, 60Hz refresh. To switch to a different video resolution color depth, or refresh rate, follow the steps below.

Selecting Monitor Type

Monitor type is initially set to DEFAULT. This DEFAULT setting may not allow you to select all resolution/refresh combinations that are available for your monitor. The following steps can be done to select monitor type. This section applies only after installation, or when a different monitor is used.

1. Open the OS/2 System folder.
2. Open the System Setup folder.
3. Open the System object.
4. When the System - Settings notebook appears, select the Screen tab. This will take you to page 2 of the settings.
5. On Screen page 2, select your monitor type from the Display Name list. If your monitor is not listed, select DEFAULT. Return to Screen page 1.

It may be necessary to restart your system to have all refresh rate options available.

Selecting Screen Resolution/Refresh Rate

To switch to a different video resolution, color depth or refresh rate,

follow the steps below.

1. Open the OS/2 System folder.
2. Open the System Setup folder.
3. Open the System object.
4. From the selection windows provided, select a new Screen Resolution and Screen refresh rate.

Please note, Refresh rates, other than 60Hz, are only valid when the display is switched to CRT only display mode.

5. Close the System-Settings notebook.
6. Perform a shutdown and restart for the changes to take effect.

Installation Notes

1. During the installation of this driver, DISPLAY.LOG and DSPINSTL.LOG files are created in \OS2\INSTALL directory. These files identify the OS/2 system files that were updated, and indicate whether the installation was successful. The DISPLAY.LOG file also contains a string that identifies the version of driver that was installed. This information may be important when reporting an installation problem.
2. During installation, DSPINSTL will invoke the SVGA Configuration program SVGA.EXE to determine the hardware configuration, and create the file \OS2\INSTALL\SVGADATA.PMI. If this file is not created, the adapter will not be supported. When this step is done, the display will be blanked, and you may see a series of flashes on the display and/or what appears to be a “corrupted” display. This is normal, as the configuration process is doing Video BIOS mode sets to determine which screen resolutions BIOS supports. This configuration information is then used to provide the System-Settings Resolution and Refresh selections.

CHAPTER 6

Audio Setup

The PCM-5862E/5862EL is equipped with an audio interface that records and playback CD-quality audio. This chapter provides instructions for installing the software drivers on the included audio driver diskettes.

Introduction

The PCM-5862E/5862EL on board audio interface provides high-quality stereo sound and FM music synthesis (ESFM) by using the ES1868 or ES1869 audio controller from ESS Technology, Inc. The audio interface can record, compress, and play back voice, sound, and music with built-in mixer control.

The PCM-5862E/5862EL on board audio interface also supports the Plug and Play (PnP) standard and provides PnP configuration for the audio, FM, and MPU-104 logical devices. It is compatible with Sound Blaster™; Sound Blaster Pro™ version 3.01, voice and music functions. The ESFM synthesizer is register compatible with the OPL3 and has extended capabilities.

DOS Utilities

The ES1868/1869 audio controller supports PC games and applications for Sound Blaster™ and Sound Blaster™ with no needs of device driver in DOS environment. The default setting for audio controller in DOS are listed as follows.

Address : 220H
IRQ : 9
DMA : 1
MPU-401 : Disabled

Changing setting in DOS

The audio controller setting can be changed in DOS environment by using the DOS SETUP utility located in the UTILITY subdirectory of audio driver diskette.

To change the setting, simply type the **DOSSET** at the DOS prompt. Follow the instructions on screen to choose the new setting for the ES1868/1869 audio controller.

Controlling volume in DOS

The ES1868/1869 audio controller provides software control on the setting of audio volumes. The VOLUME CONTROL utility located in the UTILITY subdirectory of audio driver diskette is used to control the volume setting in DOS.

To control the volume setting, simply type the **ESSVOL** at the DOS prompt with appropriate parameters. The syntax of ESSVOL is shown as follows.

ESSVOL [/?] [/v:xx] [/l:xx] [/w:xx] [/m:xx] [/c:xx] [/s:xx] [/a:xx] [/p:xx]

no option	Display all volume settings.
/?	Display this message.
/v	Change master volume.
/l	Change line volume.
/w	Change wave volume.
/m	Change microphone volume.
/c	Change CD volume.
/s	Change Synthesizer volume.
/a	Change AuxB volume.
/p	Change PC Speaker volume.
xx	Volume. Note: no xx means 0 The value range of volume is 0 - 15. [PC Speaker volume range is 0 - 7]

Driver Installation

Before you begin

To facilitate the installation of the audio drivers, you should read the instructions in this chapter carefully before you attempt installation. The audio drivers for the PCM-5862E/5862EL board are located on the audio driver diskettes. You must install the drivers by using the supplied SETUP program.

Note: *The files on the software installation diskette are compressed. Do not attempt to install the drivers by copying the files manually. You must use the supplied SETUP program to install the drivers.*

Windows 3.1 drivers

These drivers are designed to work with Microsoft Windows 3.1. You may install these drivers through Windows.

1. Run Windows to make sure that it is working correctly.
2. Place the audio driver diskette in drive A. In the Windows Program Manager, choose **File** from the Options Menu. Then from the pull-down menu, choose **Run . . .** At the command line prompt, type **A:\WIN31\SETUP**. Press the <ENTER> key or click **OK** to begin the installation.
3. Click **Continue** when the “AudioDrive Setup” screen show up. Click the **Driver Installation** button to choose installing the audio driver.
4. At this point, the setup program displays the “Set Hardware Setting” screen, which allows you to change the hardware setting of audio controller in Windows. For proper operation, make sure the address, IRQ, and DMA settings are not used by other hardware. Press <ENTER> key or click **OK** to complete the installation.

Once completed, you can change the settings or remove the audio driver by using Windows’s Control Panel program.

Windows 95 Drivers

1. Boot your system and place the audio driver diskette in drive A.
2. Select *Add New Hardware* from Windows's Control Panel.
3. Click *Next* to bring up the Windows search for new hardware setup screen.
4. Select *No* and click *Next* button.
4. Select *Sound, video and game controllers* from the *Hardware types* list and click *Next* button.
5. Click *Have Disk*, type **A:\WIN95** and press <ENTER> at the prompt.
6. Select *ES1868 Control Interface* and *ES1868 Plug and Play AudioDrive*. Press the <ENTER> key or click *OK* to begin the installation.
7. Restart your computer after the installation completed.

Programming the Watchdog Timer

The PCM-5862E/5862EL is equipped with a watchdog timer that resets the CPU or generates an interrupt if processing comes to a standstill for whatever reason. This feature ensures system reliability in industrial standalone, or unmanned, environments.

Programming the Watchdog Timer

In order to program the watchdog timer, you must write a program which writes I/O port address 443 (hex). The output data is a value of time interval. The value range is from 01(hex) to 3F(hex), and the related time interval is 1 sec. to 63 sec.

Data	Time Interval
01	1 sec.
02	2 sec.
03	3 sec.
04	4 sec.
	.
	.
	.
3F	63 sec.

After data entry, your program must refresh the watchdog timer by rewriting the I/O port 443 (hex) while simultaneously setting it. When you want to disable the watchdog timer, your program should read I/O port 443 (hex).

The following example shows how you might program the watchdog timer in BASIC:

```
10   REM Watchdog timer example program
20   OUT &H443, data REM Start and restart the watchdog
30   GOSUB 1000 REM Your application task #1
40   OUT &H443, data REM Reset the timer
50   GOSUB 2000 REM Your application task #2
60   OUT &H443, data REM Reset the timer
70   X=INP (&H043) REM Disable the watchdog timer
80   END

1000 REM Subroutine #1, you application task
    .
    .
    .
1070 RETURN
2000 REM Subroutine #2, you application task
    .
    .
    .
2090 RETURN
```

APPENDIX **B**

Installing PC/104 Modules

This appendix gives instructions for installing PC/104 modules.

B.1 Installing PC/104 modules

The PCM-5862E/5862EL's PC/104 connectors give you the flexibility to attach PC/104 modules.

Installing these modules on the PCM-5862E/5862EL is quick and simple. The following steps show how to mount the PC/104 modules:

1. Remove the PCM-5862E/5862EL from your system paying particular attention to the safety instructions already mentioned above.
2. Make any jumper or link changes required to the CPU card now. Once the PC/104 module is mounted you may have difficulty in accessing these.
3. Normal PC/104 modules have male connectors and mount directly onto the main card. (Refer to the diagram on the following page.)
4. Mount the PC/104 module onto the CPU card by pressing the module firmly but carefully onto the mounting connectors.
5. Secure the PC/104 module onto the CPU card using the four mounting spacers and screws.

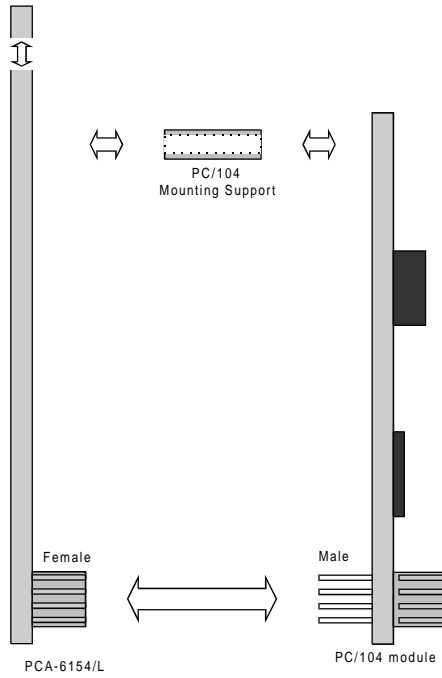

Figure B-1: PC/104 module mounting diagram

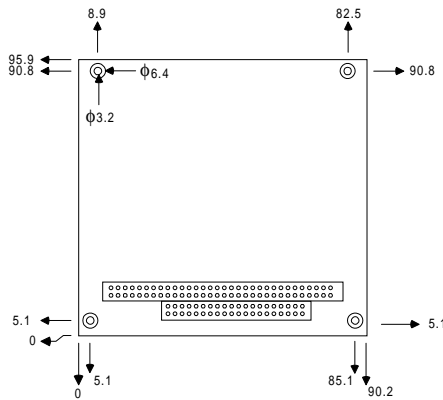

Figure B-2: PC/104 module dimensions (mm) (±0.1)

Pin Assignments

This appendix contains information of a detailed or specialized nature. It includes:

- CRT display connector
- Flat panel display connector
- PC/104 connectors
- USB connectors
- Fan power connector
- Front panel connector
- CD audio connector
- Peripheral power connector
- Ethernet 10BASE-T connector
- IR connector
- Audio connector
- Main power connector
- ATX power control connector
- ATX power control connector
- Keyboard and mouse connector
- COM port connector
- IDE hard drive connector
- Floppy drive connector
- Parallel port connector
- IRQ mapping chart
- System I/O ports
- 1st memory map
- DMA channel assignment

CRT display connector (CN1)

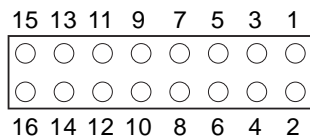

PCM-5862E/5862EL CRT display connector

Pin	Signal	Pin	Signal
1	RED	9	SIGNAL GND
2	N/C	10	H-SYNC
3	GREEN	11	CHASSIS GND
4	SIGNAL GND	12	V-SYNC
5	BLUE	13	CHASSIS GND
6	N/C	14	N/C
7	N/C	15	CHASSIS GND
8	N/C	16	N/C

Flat panel display connector (CN2)

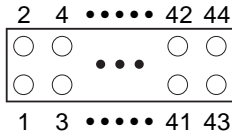

PCM-5862E/5862EL Flat panel display connector

Pin	Function	Pin	Function
1	+12 V	2	+12 V
3	GND	4	GND
5	5V/3.3V	6	5V/3.3V
7	ENAVEE*	8	GND
9	P0	10	P1
11	P2	12	P3
13	P4	14	P5
15	P6	16	P7
17	P8	18	P9
19	P10	20	P11
21	P12	22	P13
23	P14	24	P15
25	P16	26	P17
27	P18	28	P19
29	P20	30	P21
31	P22	32	P23
33	GND	34	GND
35	SHFCLK	36	FLM
37	M	38	LP
39	GND	40	ENABKL*
41	GND	42	ASHFCLK
43	ENAVDD*	44	5V/3.3V

* Low active

PC/104 connectors (CN3, CN9)

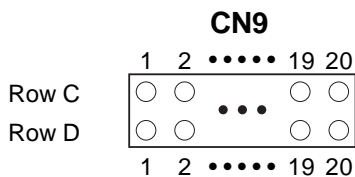
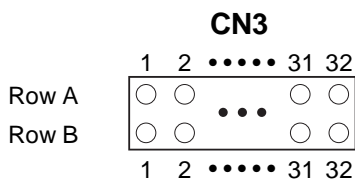

PCM-5862E/5862EL PC/104 connectors

Pin Number	Signal (CN3)		Signal (CN9)	
	RowA	RowB	RowA	RowB
1	IOCHCHK*	0V	0V	0V
2	SD7	RESET	SBHE*	MEMCS16*
3	SD6	+5V	LA23	IOCS16*
4	SD5	IRQ9	LA22	IRQ10
5	SD4	-5V	LA21	IRQ11
6	SD3	DRQ2	LA20	IRQ12
7	SD2	-12V	LA19	IRQ15
8	SD1	ENDXFR*	LA18	IRQ14
9	SD0	+12	LA17	DACK0*
10	IOCHRDY	(KEY)	MEMR*	DRQ0
11	AEN	SMEMW*	MEMW*	DACK5*
12	SA19	SMEMR*	SD8	DRQ5
13	SA18	IOW*	SD9	DACK6*
14	SA17	IOR*	SD10	DRQ6
15	SA16	DACK3*	SD11	DACK7*
16	SA15	DRQ3	SD12	DRQ7
17	SA14	DACK1*	SD13	+5V

PCM-5862E/5862EL PC/104 connectors (cont.)

Pin Number	Signal (CN3)		Signal (CN9)	
	RowA	RowB	RowA	RowB
18	SA13	DRQ1	SD14	MASTER*
19	SA12	REFRESH*	SD15	0V
20	SA11	SYSCLK	(KEY)	0V
21	SA10	IRQ7	—	—
22	SA9	IRQ6	—	—
23	SA8	IRQ5	—	—
24	SA7	IRQ4	—	—
25	SA6	IRQ3	—	—
26	SA5	DACK2*	—	—
27	SA4	TC	—	—
28	SA3	BALE	—	—
29	SA2	+5V	—	—
30	SA1	OSC	—	—
31	SA0	0V	—	—
32	0V	0V	—	—

* Low active

USB connectors (CN4, CN5)

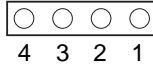

PCM-5862E/5862EL USB connector

Pin	Signal
1	+5 V
2	UV-
3	UV+
4	GND

Fan power connector (CN6)

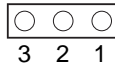

PCM-5862E/5862EL Fan power connector

Pin	Signal
1	+5 V
2	GND
3	+12 V

Front panel connector (CN7)

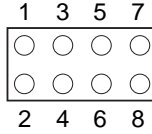

PCM-5862E/5862EL Front panel connector

Pin	Signal
1	HDD LED- (HARD DISK ACTIVE)
2	HDD LED+ (V_{CC})
3	SPEAKER+
4	SPEAKER- (GND)
5	GND
6	WATCHDOG OUTPUT*
7	RESET SWITCH- (GND)
8	RESET SWITCH+

* Low active

CD audio connector (CN8)

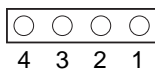

PCM-5862E/5862EL CD audio connector

Pin	Signal
1	CD AUDIO L
2	GND
3	CD AUDIO R
4	GND

Peripheral power connector (CN10)

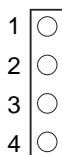

PCM-5862E/5862EL Peripheral power connector

Pin	Function
1	GND
2	-5 V
3	GND
4	-12 V

Ethernet 10BASE-T connector (CN11)

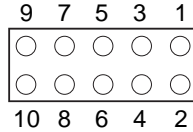

PCM-5862E/5862EL Ethernet 10BASE-T connector

Pin	Signal
1	V_{cc}
2	CRS LED
3	RCV+
4	RCV-
5	BNC LED
6	GND
7	N/C
8	GND
9	XMT+
10	XMT-

IR connector (CN12)

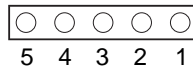

PCM-5862E/5862EL IR connector

Pin	Signal
1	V_{cc}
2	NC
3	IR IN
4	GND
5	IR OUT

Audio connector (CN13)

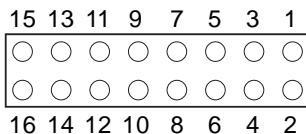

PCM-5862E/5862EL audio connector

Pin	Signal	Pin	Signal
1	SPEAKER OUT R+	2	SPEAKER OUT R-
3	SPEAKER OUT L+	4	SPEAKER OUT L-
5	LINE OUT R	6	LINE OUT L
7	GND	8	GND
9	LINE IN R	10	LINE IN L
11	GND	12	GND
13	NC	14	NC
15	MIC IN	16	GND

Main power connector (CN14)

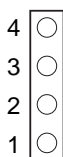

PCM-5862E/5862EL Main power connector

Pin	Signal
1	+12 V
2	GND
3	GND
4	+5 V

Keyboard and PS/2 mouse connector (CN15)

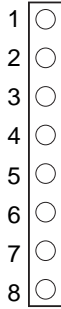

PCM-5862E/5862EL Keyboard and mouse connector

Pin	Signal
1	GND
2	MS VCC
3	MS DATA
4	MS CLOCK
5	GND
6	KB VCC
7	KB DATA
8	KB CLOCK

COM port connector (CN16)

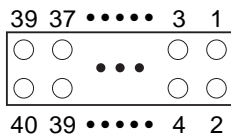

PCM-5862E/5862EL COM port connector

Pin	Signal	Pin	Signal
1	RLSD1	2	DSR1
3	RX1	4	RTS1
5	TX1	6	CTS1
7	DTR1	8	RI1
9	GND	10	NC
11	RLSD2	12	DSR2
13	RX2	14	RTS2
15	TX2	16	CTS2
17	DTR2	18	RI2
19	GND	20	NC
21	RLSD3	22	DSR3
23	RX3	24	RTS3
25	TX3	26	CTS3
27	DTR3	28	RI3
29	GND	30	NC
31	RLSD4	32	DSR4
33	RX4	34	RTS4
35	TX4	36	CTS4
37	DTR4	38	RI4
39	GND	40	NC

Note: The cable of serial port (CN16) comes with four DSUB-9 male connectors. The pin assignments of each DSUB-9 connector are listed below for your reference:

DSUB-9 Conn.(RS-232) mode	RS-422 mode	RS-485 module
Pin	Signal	Signal
1	DCD	TX-
2	RxD	TX+
3	TxD	RX+
4	DTR	RX-
5	GND	GND
6	DSR	NC
7	RTS	NC
8	CTS	NC
9	RI	NC

IDE hard drive connector (CN17)

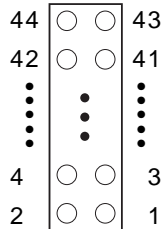

PCM-5862E/5862EL IDE hard drive connector

Pin	Signal	Pin	Signal
1	IDE RESET*	2	GND
3	DATA 7	4	DATA 8
5	DATA 6	6	DATA 9
7	DATA 5	8	DATA 10
9	DATA 4	10	DATA 11
11	DATA 3	12	DATA 12
13	DATA 2	14	DATA 13
15	DATA 1	16	DATA 14
17	DATA 0	18	DATA 15
19	SIGNAL GND	20	N/C
21	HDD 0	22	GND
23	IO WRITE	24	GND
25	IO READ	26	GND
27	HD READY	28	N/C
29	HDACK 0*	30	GND
31	IRQ14	32	N/C
33	ADDR 1	34	N/C
35	ADDR 0	36	ADDR 2
37	HARD DISK SELECT 0*		
38	HARD DISK SELECT 1*		
39	IDE ACTIVE*	40	GND
41	VCC	42	VCC
43	GND	44	N/C

* Low active

Floppy drive connector (CN18)

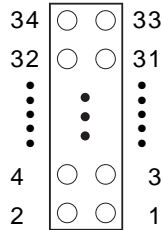

PCM-5862E/5862EL Floppy drive connector

Pin	Signal	Pin	Signal
1	GND	2	DENSITY SELECT*
3	GND	4	N/C
5	GND	6	DRIVE TYPE
7	GND	8	INDEX*
9	GND	10	MOTOR 0*
11	GND	12	DRIVE SELECT 1*
13	GND	14	DRIVE SELECT 0*
15	GND	16	MOTOR 1*
17	GND	18	DIRECTION*
19	GND	20	STEP*
21	GND	22	WRITE DATA*
23	GND	24	WRITE GATE*
25	GND	26	TRACK 0*
27	GND	28	WRITE PROTECT*
29	GND	30	READ DATA*
31	GND	32	HEAD SELECT*
33	GND	34	DISK CHANGE*

* Low active

Parallel port connector (CN19)

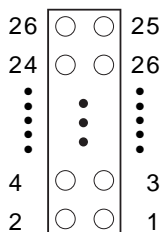

PCM-5862E/5862EL Parallel port connector

Pin	Signal	Pin	Signal
1	STROBE*	2	AUTOFD*
3	D0	4	ERR
5	D1	6	INIT*
7	D2	8	SLCTINI*
9	D3	10	GND
11	D4	12	GND
13	D5	14	GND
15	D6	16	GND
17	D7	18	GND
19	ACK*	20	GND
21	BUSY	22	GND
23	PE	24	GND
25	SLCT	26	N/C

* Low active

ATX Power Feature Connector (CON1)

PCM-5862E/5862EL ATX Feature Connector

Pin	Signal
1	VPSON
2	N.C.
3	5VSB (stand by voltage)

ATX Soft Power Switch Connector (CON2)

PCM-5862E/5862EL ATX Soft Switch Connector

Pin	Signal
1	GND
2	SWITCH

System I/O Ports

PCM-5862E/5862EL System I/O ports

Addr. range (Hex)	Device
000-01F	DMA controller
020-021	Interrupt controller 1, master
022-023	Chipset address
040-05F	8254 timer
060-06F	8042 (keyboard controller)
070-07F	Real-time clock, non-maskable interrupt (NMI) mask
080-09F	DMA page register,
0A0-0BF	Interrupt controller 2
0C0-0DF	DMA controller
0F0	Clear math co-processor
0F1	Reset math co-processor
0F8-0FF	Math co-processor
1F0-1F8	Fixed disk
200-207	Game I/O
278-27F	Reserved
2E8-2EF	Serial port 4
2F8-2FF	Serial port 2
300-31F	Prototype card
360-36F	Reserved
378-37F	Parallel printer port 1 (LPT 2)
380-38F	SDLC, bisynchronous 2
3A0-3AF	Bisynchronous 1
3B0-3BF	Monochrome display and printer adapter(LPT1)
3C0-3CF	Reserved
3D0-3DF	Color/graphics monitor adapter
3E8-3EF	Serial port 3
3F0-3F7	Diskette controller
3F8-3FF	Serial port 1
443	Watchdog timer

* PNP audio I/O map range from 220 ~ 250H (16 bytes)
MPU-401 select from 300 ~ 330H (2 bytes)

1st MB Memory Map

PCM-5862E/5862EL 1st MB memory map

Addr. range (Hex)	Device
F000h - FFFFh	System ROM
DC00h - EFFFh	Unused
*CC00h - DBFFh	Ethernet ROM
C000h - CBFFh	Expansion ROM
B800h - BFFFh	CGA/EGA/VGA text
B000h - B7FFh	Unused
A000h - AFFFh	EGA/VGA graphics
0000h - 9FFFh	Base memory

* If Ethernet Boot ROM enabled

DMA Channel Assignments

PCM-5862E/5862EL DMA channel assignments

Channel	Function
0	Available
1	Available (Audio)
2	Floppy disk (8-bit transfer)
3	Available (Parallel Port)
4	Cascade for DMA controller 1
5	Available
6	Available
7	Available

* Audio DMA select 0, 1 or 3

** Parallel Port DMA select 1 or 3

IRQ mapping chart

PCM-5862E/5862EL IRQ mappingg ch5862E/5862ELction

0	5862E/5862ELer
1	Keyboard
2	Interrupt from Controller 2
3	COM2
4	COM1
5	COM4
6	FDD
7	LPT1
8	RTC
9	Reserved (Audio)
10	COM3
11	Reserved (Ethernet)
12	PS/2 mouse
13	INT from co-processor
14	Primary IDE
15	Watchdog Timer

* Ethernet interface IRQ select: 9, 11, 12, 15

* PnP audio IRQ select: 9, 11, 12, 15

* PnP USB IRQ select: 9, 11, 12, 15

APPENDIX
D

Optional Extras

PCM-10586-2 Cable kit for PCM-5862E/5862EL

The PCM-5862E/5862EL requires several cables for normal operation. You can make them yourself or purchase an optional cable kit assembly, which includes the following:

Part No.	Cable Description	PCM-5862EL Connector	Terminating Connector
1701440350	2.5" and 1.8" IDE, IDC44P/IDC 44P /IDC44P	CN17	44-pin, 2mm, female IDC(350mm)
1701440500	3.5" IDE (40P), IDC 40P/IDC 40P /Housing 44P	CN17	40-pin, 2.54mm, female IDC(500mm)
1701340700 and 5.25"(34p)	Dual Floppy, 3.5"	CN18	34-pin Dual Floppy
1701260301	Parallel Port	CN19	25-pin female DSUB
1701100200	Network, 10-Base-T	CN11	RJ45 8-pin modular jack
1701150150	VGA CRT	CN1	15-pin DSUB
1700060200	Keyboard and PS/2 mouse	CN15	5-pin circular DIN, 6-pin circular DIN
1703040300	Peripheral power (-5V and -12V)	CN14	(4-conductor) (300mm)
1701440303	LCD Cable	CN2	44-pin, 2mm, pitch(300)mm
1701080300	Front Panel	CN7	(8-conductor pigtail)
1700400000	COM 1-4 cable	CN16	40-pin, 9pin male DSUB x4
1700160000	Audio cable	CN13	Ø - 3.5mm, female phone jack x3

Optional LCD Cables for 9.4" MONO, 10.4" TFT LCD Panel

Optional LCD Cables for 9.4" MONO, 10.4" TFT LCD Panel		
Part No.	Cable Discription	Panel Type
1700090501	Cable DF9 (2 mm) 50 cm	Toshiba LTM10C042
1700090403	Cable DF9 (2 mm) 40 cm	Sharp LM64183P Sharp LM64P89
1703440151	Wire 30P/44P 15 cm	Toshiba LTM12C275A

Optional USB cable

Optional USB cable part no: 1700080170

