



**Netz-Thyristor**  
**Phase Control Thyristor**
**T 1451N**
**Elektrische Eigenschaften / Electrical properties**  
**Höchstzulässige Werte / Maximum rated values**

Periodische Vorwärts- und Rückwärts-Spitzensperrspannung repetitive peak forward off-state and reverse voltages	$T_d = -40^\circ\text{C} \dots T_{d\text{max}}$	$V_{DRM}, V_{RRM}$	4800 5200	5000	V V
Periodische Vorwärts- und Rückwärts-Spitzensperrspannung repetitive peak forward off-state and reverse voltages	$T_d = 0^\circ\text{C} \dots T_{d\text{max}}$	$V_{DRM}, V_{RRM}$	4950 5350	5150	V V
Durchlaßstrom-Grenzeffektivwert maximum RMS on-state current		$I_{T(RMS)}$		3550	A
Dauergrenzstrom average on-state current	$T_c = 85^\circ\text{C}$ $T_c = 60^\circ\text{C}$	$I_{T(AVG)}$		1680 2260	A A
Stoßstrom-Grenzwert surge current	$T_d = 25^\circ\text{C}, t_p = 10\text{ ms}$ $T_d = T_{d\text{max}}, t_p = 10\text{ ms}$	$I_{TSM}$	44000 43000		A A
Grenzlastintegral I <sup>2</sup> -value	$T_d = 25^\circ\text{C}, t_p = 10\text{ ms}$ $T_d = T_{d\text{max}}, t_p = 10\text{ ms}$	PI	4800 4000		10 <sup>4</sup> A <sup>2</sup> s 10 <sup>4</sup> A <sup>2</sup> s
Kritische Stromsteilheit critical rate of rise of on-state current	DIN IEC 60747-6 $f = 50\text{ Hz}, I_{GM} = 3\text{ A}, di_G/dt = 6\text{ A}/\mu\text{s}$	$(di_T/dt)_{cr}$		300	A/ $\mu\text{s}$
Kritische Spannungssteilheit critical rate of rise of off-state voltage	$T_d = T_{d\text{max}}, V_D = 0,67 V_{DRM}$ 5.Kennbuchstabe / 5 <sup>th</sup> letter H	$(dv_D/dt)_{cr}$		2000	V/ $\mu\text{s}$

**Charakteristische Werte / Characteristic values**

Durchlaßspannung on-state voltage	$T_d = T_{d\text{max}}, I_T = 2000\text{ A}$	$v_T$	typ. max.	1,57 1,70	V V
Schleusenspannung threshold voltage	$T_d = T_{d\text{max}}$	$V_{T(0)}$	typ. max.	0,88 0,92	V V
Ersatzwiderstand slope resistance	$T_d = T_{d\text{max}}$	$r_T$	typ. max.	0,34 0,37	m $\Omega$ m $\Omega$
Durchlaßkennlinie on-state characteristic	$T_d = T_{d\text{max}}$	typ.	A B C D	0,497 0,000137 -0,0127 0,02	
		max.	A B C D	0,539 0,000193 0,00534 0,0164	
Zündstrom gate trigger current	$T_d = 25^\circ\text{C}, V_D = 6\text{ V}$	$I_{GT}$	max.	350	mA
Zündspannung gate trigger voltage	$T_d = 25^\circ\text{C}, V_D = 6\text{ V}$	$V_{GT}$	max.	2,5	V
Nicht zündender Steuerstrom gate non-trigger current	$T_d = T_{d\text{max}}, V_D = 6\text{ V}$ $T_d = T_{d\text{max}}, V_D = 0,5 V_{DRM}$	$I_{GP}$	max. max.	20 10	mA mA
Nicht zündende Steuerspannung gate non-trigger voltage	$T_d = T_{d\text{max}}, V_D = 0,5 V_{DRM}$	$V_{GP}$	max.	0,4	V
Haltestrom holding current	$T_d = 25^\circ\text{C}, V_D = 6\text{ V}, R_A = 5\ \Omega$	$I_H$	max.	350	mA
Einraststrom latching current	$T_d = 25^\circ\text{C}, V_D = 6\text{ V}, R_{AK} \geq 10\ \Omega$ $I_{GM} = 3\text{ A}, di_G/dt = 6\text{ A}/\mu\text{s}, t_g = 20\ \mu\text{s}$	$I_L$	max.	3	A
Vorwärts- und Rückwärts-Sperrstrom forward off-state and reverse current	$T_d = T_{d\text{max}}$ $V_D = V_{DRM}, V_R = V_{RRM}$	$I_{FO}, I_{RO}$	max.	400	mA
Zündverzug gate controlled delay time	DIN IEC 60747-6 $T_d = 25^\circ\text{C}, I_{GM} = 3\text{ A}, di_G/dt = 6\text{ A}/\mu\text{s}$	$t_{gd}$	max.	2	$\mu\text{s}$

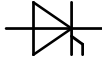
prepared by:	J. Przybilla	date of publication:	15.05.03
approved by:	R. Keller	revision:	4

**Netz-Thyristor**  
**Phase Control Thyristor**
**T 1451N**
**Elektrische Eigenschaften / Electrical properties**  
 Charakteristische Werte / Characteristic values

Freiwerdezeit circuit commutated turn-off time	$T_{vj} = T_{vj\ max}$ , $i_{TM} = I_{TAVM}$ $V_{RM} = 100\ V$ , $v_{DM} = 0,67\ V_{DRM}$ $dv_D/dt = 20\ V/\mu s$ , $-di_T/dt = 10\ A/\mu s$ 4.Kennbuchstabe / 4 <sup>th</sup> letter O	$t_q$	typ. 450	$\mu s$
Sperrverzögerungsladung recovered charge	$T_{vj} = T_{vj\ max}$ $i_{TM} = I_{TAVM}$ , $-di_T/dt = 10\ A/\mu s$ $V_R = 0,5V_{RRM}$ , $V_{RM} = 0,8V_{RRM}$	$Q_f$	max. 15	mAs
Rückstromspitze peak reverse recovery current	$T_{vj} = T_{vj\ max}$ $i_{TM} = I_{TAVM}$ , $-di_T/dt = 10\ A/\mu s$ $V_R = 0,5V_{RRM}$ , $V_{RM} = 0,8V_{RRM}$	$I_{RM}$	max. 320	A

**Thermische Eigenschaften / Thermal properties**

Innerer Wärmewiderstand thermal resistance, junction to case	<u>Kühlfläche / cooling surface</u> beidseitig / two-sided, $\theta = 180^\circ\ sin$ beidseitig / two-sided, DC Anode / anode, DC Kathode / cathode, DC	$R_{thJC}$	max. 0,0097 max. 0,009 max. 0,014 max. 0,0250	$^\circ C/W$ $^\circ C/W$ $^\circ C/W$ $^\circ C/W$
Übergangs-Wärmewiderstand thermal resistance, case to heatsink	<u>Kühlfläche / cooling surface</u> beidseitig / two-sided einseitig / single-sided	$R_{thCH}$	max. 0,0025 max. 0,005	$^\circ C/W$ $^\circ C/W$
Höchstzulässige Sperrschichttemperatur maximum junction temperature		$T_{vj\ max}$	125	$^\circ C$
Betriebstemperatur operating temperature		$T_{c\ op}$	-40...+125	$^\circ C$
Lagertemperatur storage temperature		$T_{stg}$	-40...+150	$^\circ C$

**Mechanische Eigenschaften / Mechanical properties**

Gehäuse, siehe Anlage case, see annex			Seite 3 page 3	
Si-Element mit Druckkontakt Si-pellet with pressure contact				
Anpresskraft clamping force		F	36...52	kN
Steueranschlüsse control terminals	DIN 46244 Gate Kathode /Cathode		A 4,8x0,8 A 6,3x0,8	
Gewicht weight		G	typ. 1500	g
Kriechstrecke creepage distance			33	mm
Schwingfestigkeit vibration resistance	f = 50 Hz		50	m/s <sup>2</sup>

Mit diesem Datenblatt werden Halbleiterbauelemente spezifiziert, jedoch keine Eigenschaften zugesichert. Sie gilt in Verbindung mit den zugehörigen technischen Erläuterungen.

This data sheet specifies semiconductor devices, but promises no characteristics. It is valid in combination with the belonging technical notes.

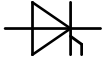
**N****Datenblatt / Data sheet**

power electronics in motion

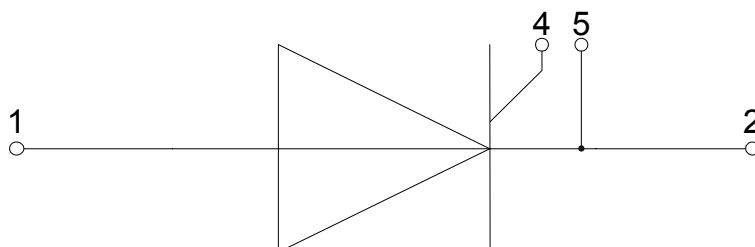
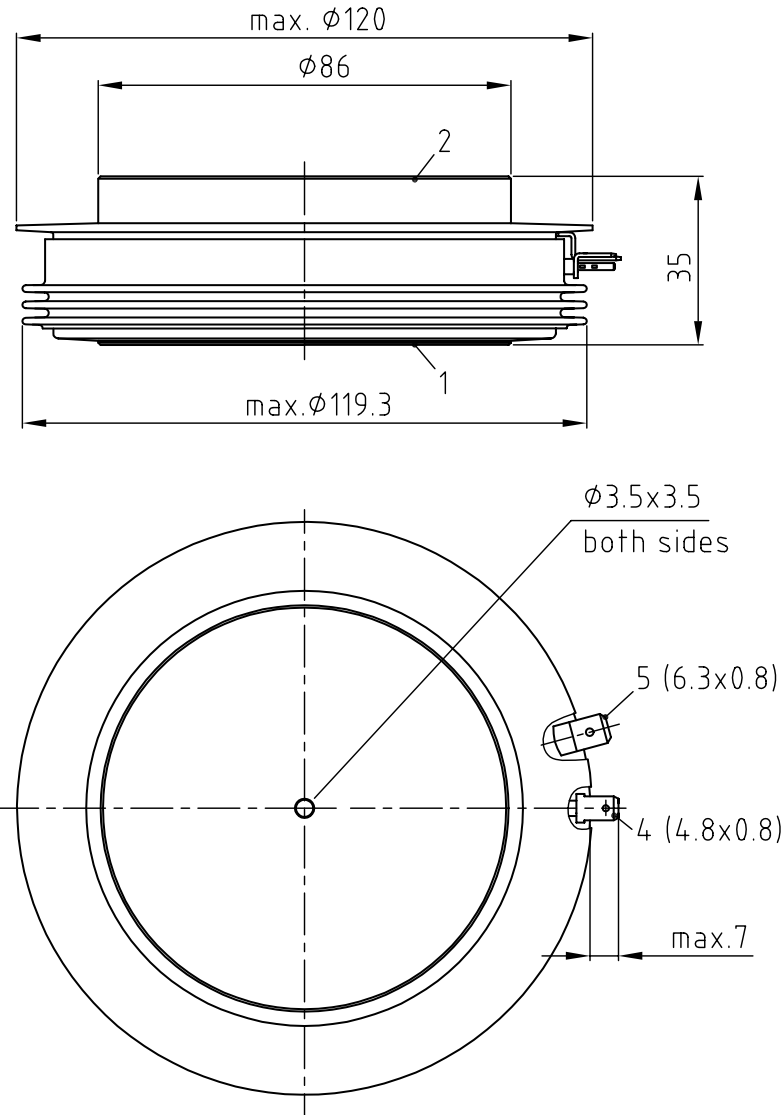
**eupec****Netz-Thyristor  
Phase Control Thyristor****T 1451N****1: Anode/Anode****2: Kathode/Cathode****4: Gate****5: Hilfskathode/  
Cathode (control terminal)**

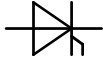

Netz-Thyristor  
Phase Control Thyristor

**T 1451N**

**Analytische Elemente des transienten Wärmewiderstandes  $Z_{thJC}$**   
**Analytical elements of transient thermal impedance  $Z_{thJC}$**

	Pos. n	1	2	3	4	5	6	7
beidseitig two-sided	$R_{thn}$ [°C/W]	0,00223	0,0027	0,0028	0,0008	0,00047		
	$\tau_n$ [s]	2,18	0,44	0,11	0,015	0,0041		
anodenseitig anode-sided	$R_{thn}$ [°C/W]	0,00623	0,0037	0,0028	0,0008	0,00047		
	$\tau_n$ [s]	6,1	0,6	0,11	0,015	0,0041		
kathodenseitig cathode-sided	$R_{thn}$ [°C/W]	0,01503	0,0059	0,0028	0,0008	0,00047		
	$\tau_n$ [s]	14,7	0,96	0,11	0,015	0,0041		

Analytische Funktion / Analytical function:

$$Z_{thJC} = \sum_{n=1}^{n_{max}} R_{thn} \left( 1 - e^{-\frac{t}{\tau_n}} \right)$$

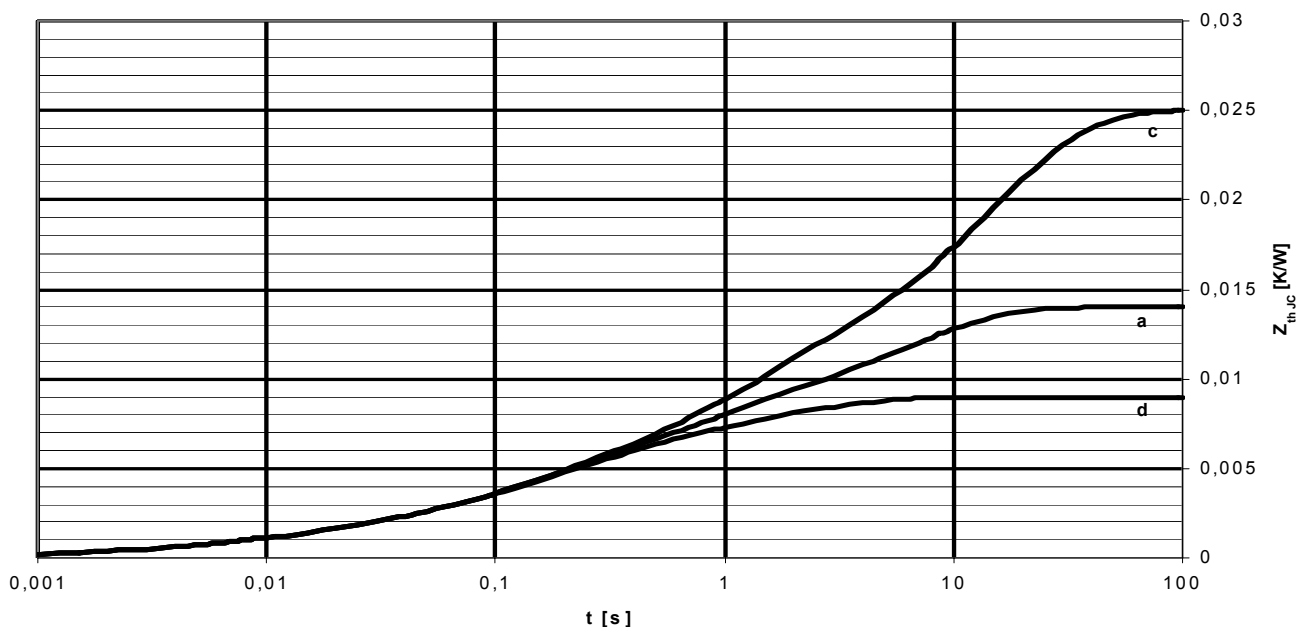

**Transienter innerer Wärmewiderstand für DC/ Transient thermal impedance  $Z_{thJC} = f(t)$  for DC**

Beidseitige Kühlung / Two-sided cooling

Anodenseitige Kühlung / Anode-sided cooling

Kathodenseitige Kühlung / Cathode-sided cooling

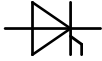

Netz-Thyristor  
Phase Control Thyristor

T 1451N

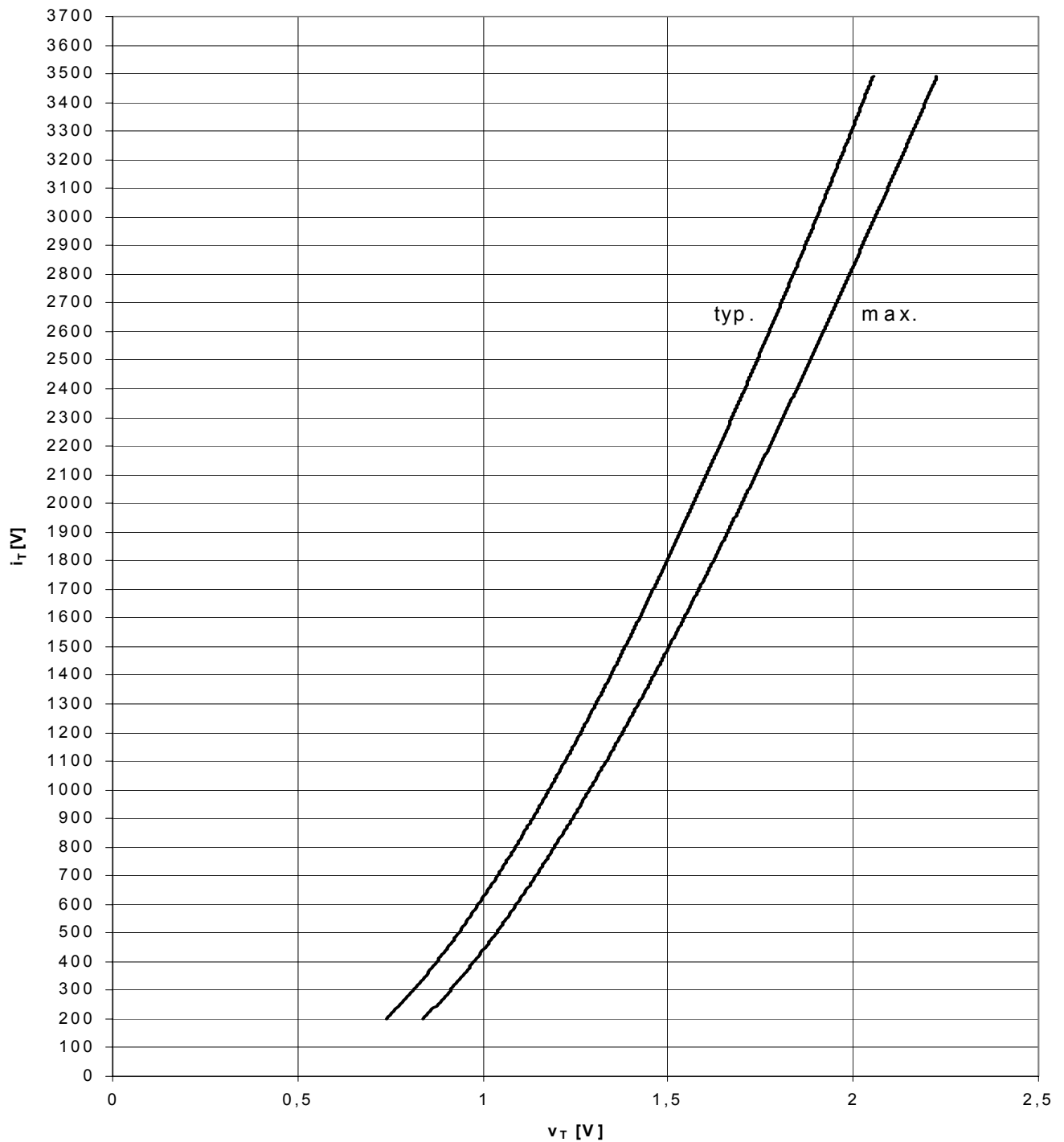

Grenzdurchlaßkennlinie / Limiting on-state characteristic  $i_T = f(v_T)$

$$T_{vj} = T_{vj \max}$$

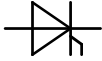

Netz-Thyristor  
Phase Control Thyristor

T 1451N

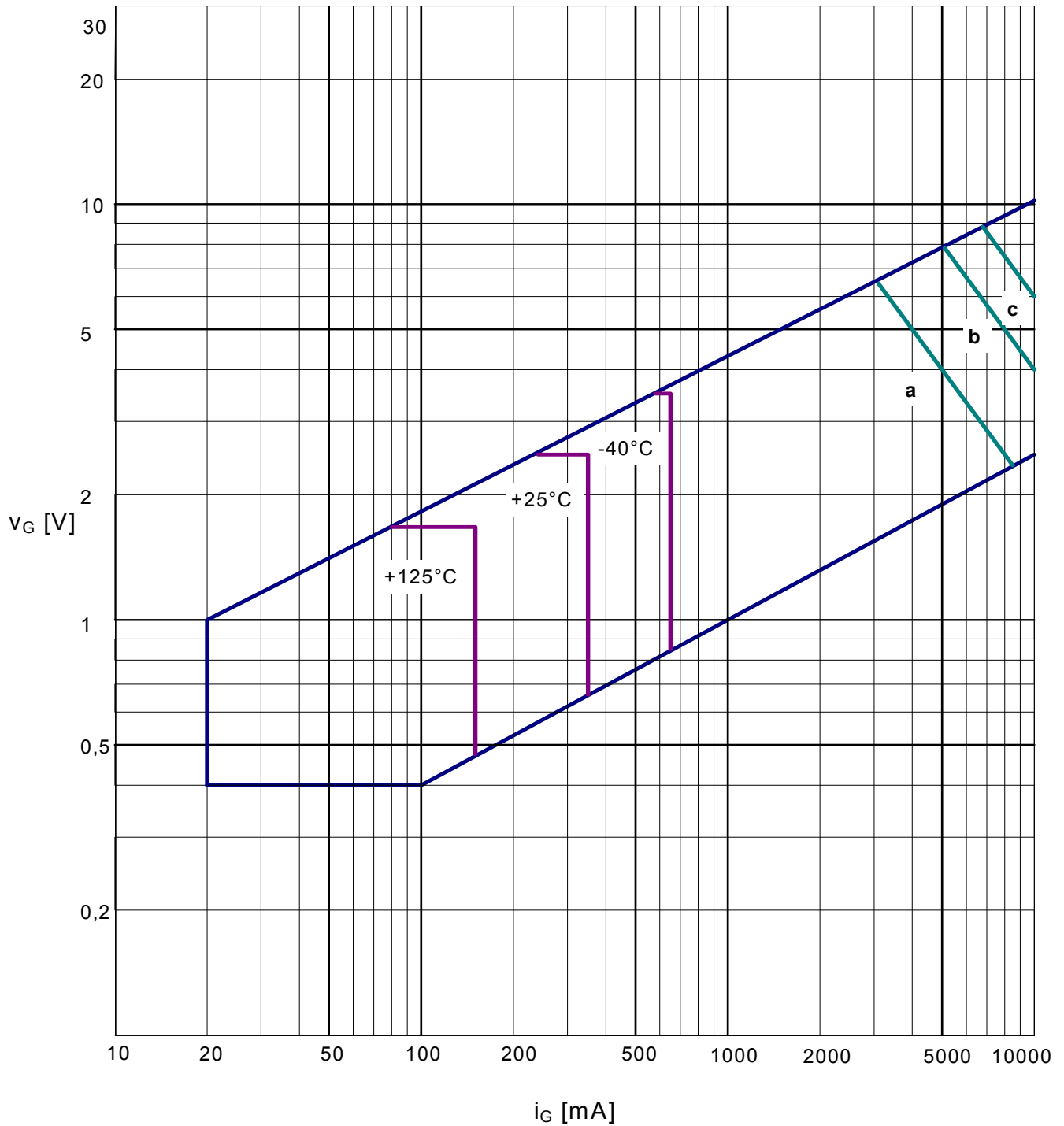

Steuercharakteristik  $v_G = f(i_G)$  mit Zündbereichen für  $V_D = 6$  V  
Gate characteristic  $v_G = f(i_G)$  with triggering area for  $V_D = 6$  V

Höchstzulässige Spitzensteuerverlustleistung / Maximum rated peak gate power dissipation  $P_{GM} = f(t_g)$  :

a - 20 W/10ms b - 40 W/1ms c - 60 W/0,5ms



Netz-Thyristor  
Phase Control Thyristor

**T 1451N**

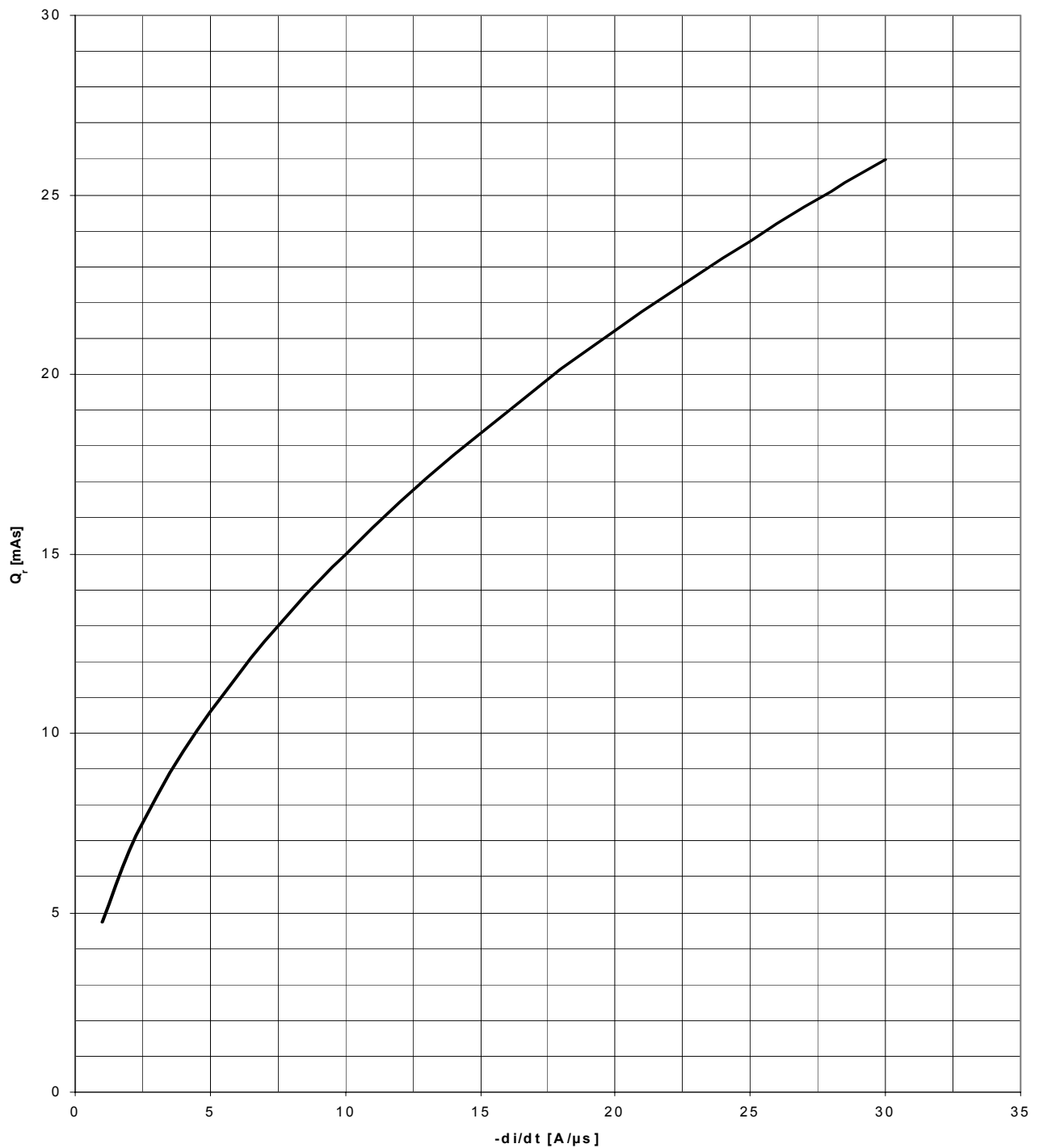

Sperrverzögerungsladung / Recovered charge  $Q_r = f(-di/dt)$

$$T_{vj} = T_{vjmax}, V_R = 0,5 V_{RRM}, V_{RM} = 0,8 V_{RRM}$$

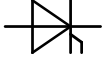

Netz-Thyristor  
Phase Control Thyristor

**T 1451N**

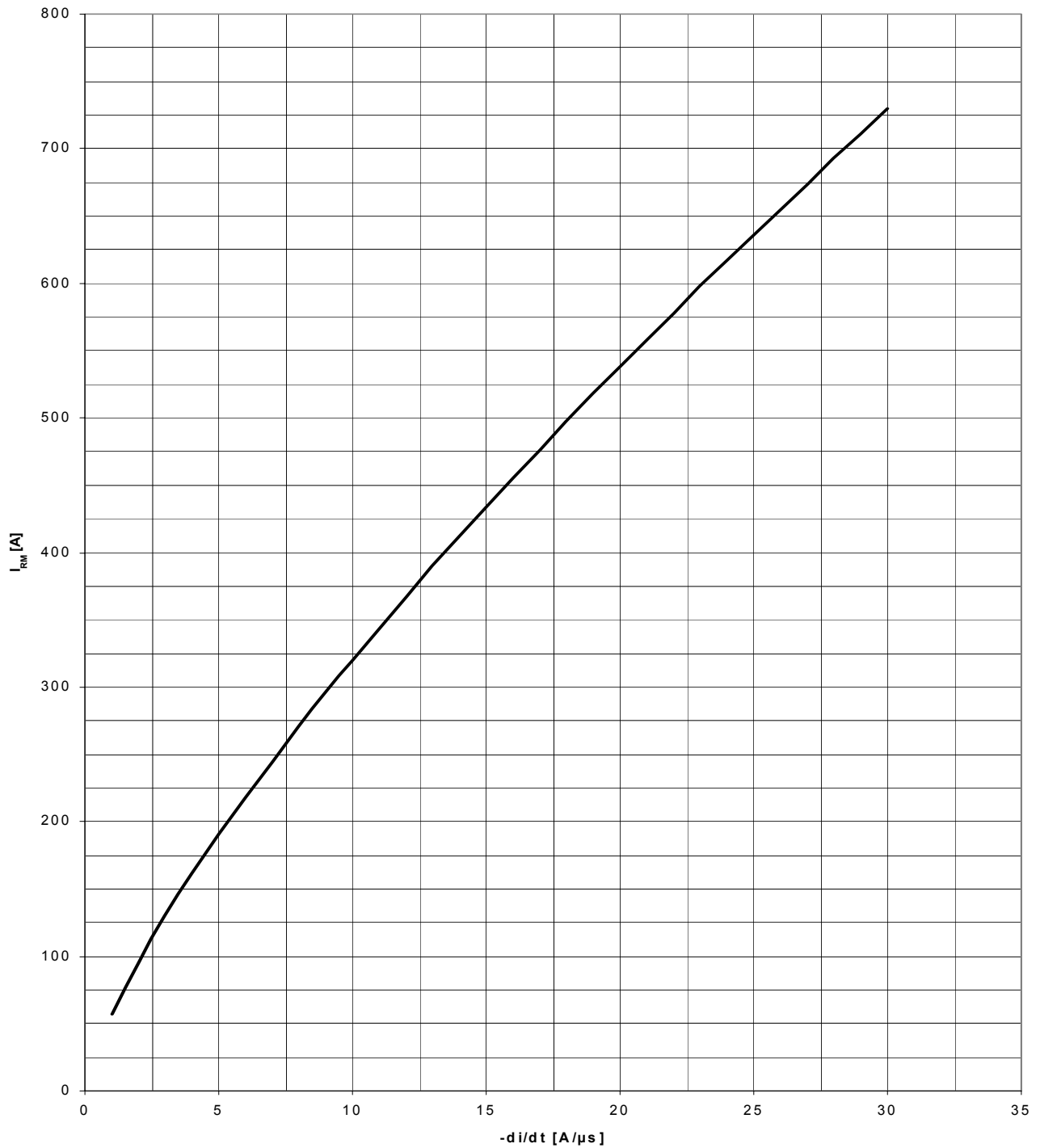

Rückstromspitze / Peak reverse recovery current  $I_{RM} = f(-di/dt)$

$$T_{vj} = T_{vjmax}, V_R = 0,5 V_{RRM}, V_{RM} = 0,8 V_{RRM}$$



## **Terms & Conditions of Usage**

### **Attention**

The present product data is exclusively subscribed to technically experienced staff. This Data Sheet is describing the specification of the products for which a warranty is granted exclusively pursuant the terms and conditions of the supply agreement. There will be no guarantee of any kind for the product and its specifications. Changes to the Data Sheet are reserved.

You and your technical departments will have to evaluate the suitability of the product for the intended application and the completeness of the product data with respect to such application. Should you require product information in excess of the data given in the Data Sheet, please contact your local Sales Office via "[www.eupec.com](http://www.eupec.com) / sales & contact".

### **Warning**

Due to technical requirements the products may contain dangerous substances. For information on the types in question please contact your local Sales Office via "[www.eupec.com](http://www.eupec.com) / sales & contact".