

FEATURES

- Specified over Temperature
- Low Power Consumption (5 μ A Typ)
- Precision Voltage Monitor of Voltages from 2.5 V to 5 V at 100 mV Increments
- Reset Assertion Down to $V_{CC} > 1$ V
- Reset Timeout Periods: 1 ms, 20 ms, 140 ms, or 1120 ms (Min)
- Built-In Manual Reset
- Pin Compatible with the ADM811
- Available in SOT-143 Package

APPLICATIONS

- Microprocessor Systems
- Controllers
- Intelligent Instruments
- Automotive Systems
- Safety Systems
- Portable Instruments

GENERAL DESCRIPTION

The ADM6315 is a reliable voltage monitoring device that is suitable for use in most voltage monitoring applications.

The ADM6315 is designed to monitor as little as a 1.8% degradation of a power supply voltage. Voltages that can be monitored by the ADM6315 are all voltages (at 100 mV increments) from 2.5 V to 5 V.

Included in this circuit is a debounced manual reset input. $\overline{\text{RESET}}$ can be activated using an ordinary switch (pulling $\overline{\text{MR}}$ low), a low input from another digital device, or a degradation of the supply voltage. The manual reset function is very useful, especially if the circuit in which the ADM6315 is operating enters into a state that can be detected only by the user. Allowing the user to manually reset a system can reduce the damage or danger that could otherwise be caused by an out-of-control or locked-up system.

The ADM6315 comes in a cost and space efficient SOT-143 package.

FUNCTIONAL BLOCK DIAGRAM

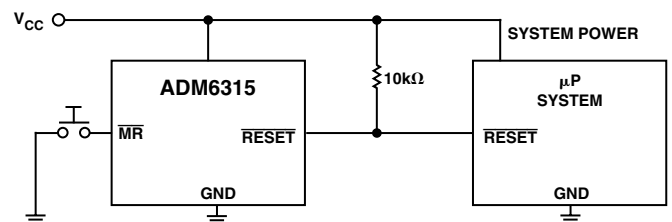
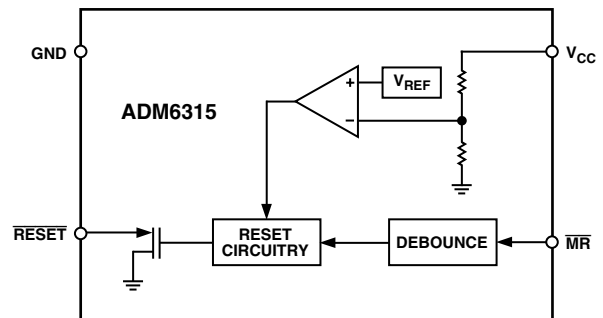

Figure 1. Typical Operating Circuit

REV. C

Information furnished by Analog Devices is believed to be accurate and reliable. However, no responsibility is assumed by Analog Devices for its use, nor for any infringements of patents or other rights of third parties that may result from its use. No license is granted by implication or otherwise under any patent or patent rights of Analog Devices. Trademarks and registered trademarks are the property of their respective owners.

ADM6315—SPECIFICATIONS (V_{CC} = Full Operating Range, T_A = T_{MIN} to T_{MAX}, V_{CC} Typ = 5 V, unless otherwise noted.)

Parameter	Min	Typ	Max	Unit	Test Conditions/Comments
SUPPLY					
Operating Voltage	1		5.5	V	T _A = -40°C to +85°C
V _{CC} Supply Current		5	12	μA	V _{CC} = 5.5 V, No Load, T _A = -40°C to +85°C
		4	15	μA	V _{CC} = 5.5 V, No Load, T _A = -40°C to +125°C
			10	μA	V _{CC} = 3.6 V, No Load, T _A = -40°C to +85°C
			12	μA	V _{CC} = 3.6 V, No Load, T _A = -40°C to +125°C
RESET VOLTAGE THRESHOLD (V_{TH})					
	V _{TH} - 1.8%		V _{TH} + 1.8%	V	T _A = 25°C
	V _{TH} - 2.5%		V _{TH} + 2.5%	V	T _A = -40°C to +85°C
	V _{TH} - 3.5%		V _{TH} + 3.5%	V	T _A = -40°C to +125°C
RESET THRESHOLD TEMPERATURE COEFFICIENT					
		60		ppm/°C	
V_{CC} TO RESET DELAY					
		35		μs	V _{CC} = Falling at 1 mV/μs
RESET ACTIVE TIMEOUT PERIOD					
ADM6315xxD1	1	1.4	2	ms	T _A = -40°C to +85°C
	0.8		2.4	ms	T _A = -40°C to +125°C
ADM6315xxD2	20	28	40	ms	T _A = -40°C to +85°C
	16		48	ms	T _A = -40°C to +125°C
ADM6315xxD3	140	200	280	ms	T _A = -40°C to +85°C
	112		336	ms	T _A = -40°C to +125°C
ADM6315xxD4	1120	1570	2240	ms	T _A = -40°C to +85°C
	896		2688	ms	T _A = -40°C to +125°C
MANUAL RESET					
Input Threshold	0.8		2.4	V	V _{TH} > 4 V (V _{IL})
				V	V _{TH} > 4 V (V _{IH})
	0.3 V _{CC}		0.7 V _{CC}	V	V _{TH} < 4 V (V _{IL})
				V	V _{TH} < 4 V (V _{IH})
Minimum Input Pulse	1			μs	
Glitch Rejection		100		ns	
To Reset Delay		500		ns	
Pull-Up Resistance	32	63	100	kΩ	
RESET OUTPUT					
Output Voltage			0.4	V	V _{CC} > 4.25 V, I _{SINK} = 3.2 mA
			0.3	V	V _{CC} > 2.5 V, I _{SINK} = 1.2 mA
			0.3	V	V _{CC} > 1 V, I _{SINK} = 80 μA
Output Leakage Current			1	μA	V _{CC} > V _{TH} , RESET De-asserted

Specifications subject to change without notice.

ABSOLUTE MAXIMUM RATINGS*

(T_A = 25°C, unless otherwise noted.)

Terminal Voltage (With Respect to Ground)

V_{CC} -0.3 V to +6 V

All Other Inputs -0.3 V to +6 V

Input Current

V_{CC} 20 mA

Output Current

$\overline{\text{RESET}}$ 20 mA

Power Dissipation (T_A = 70°C)

RA-4, SOT-143

Derate by 4 mW/°C above 70°C 320 mW

θ_{JA} Thermal Impedance 330°C/W

Operating Temperature Range -40°C to +125°C

Storage Temperature Range -65°C to +160°C

Lead Temperature (Soldering, 10 sec) 300°C

Vapor Phase (60 sec) 215°C

Infrared (15 sec) 220°C

ESD Rating 2.5 kV

*Stresses above those listed under Absolute Maximum Ratings may cause permanent damage to the device. This is a stress rating only; functional operation of the device at these or any other conditions above those listed in the operational sections of this specification is not implied. Exposure to absolute maximum ratings for extended periods may affect device reliability.

PIN CONFIGURATION

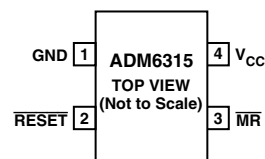

PIN FUNCTION DESCRIPTIONS

Pin	Mnemonic	Function
1	GND	0 V. Ground reference for all signals.
2	$\overline{\text{RESET}}$	Active Low Logic Output. $\overline{\text{RESET}}$ remains low while V _{CC} is below the reset threshold or when $\overline{\text{MR}}$ is low; $\overline{\text{RESET}}$ then remains low for either 1 ms (min), 20 ms (min), 140 ms (min), or 1120 ms (min) after V _{CC} rises above the reset threshold and $\overline{\text{MR}}$ is high.
3	$\overline{\text{MR}}$	Manual Reset. This active low debounced input will ignore input pulses of 100 ns (typical) and is guaranteed to accept input pulses of greater than 1 μs. Leave floating when not used.
4	V _{CC}	Monitored Supply Voltage.

CAUTION

ESD (electrostatic discharge) sensitive device. Electrostatic charges as high as 4000 V readily accumulate on the human body and test equipment and can discharge without detection. Although the ADM6315 features proprietary ESD protection circuitry, permanent damage may occur on devices subjected to high energy electrostatic discharges. Therefore, proper ESD precautions are recommended to avoid performance degradation or loss of functionality.



ADM6315

ORDERING GUIDE

Model	Temperature Range	Package Description	Package Option	Trip Point	Min Timeout (ms)	Branding
ADM6315-46D1ART-RL7	-40°C to +125°C	Small Outline Transistor (SOT-143)	RA-4	4.63	1	MDV
ADM6315-46D1ART-RL	-40°C to +125°C	Small Outline Transistor (SOT-143)	RA-4	4.63	1	MDV
ADM6315-45D1ART-RL7	-40°C to +125°C	Small Outline Transistor (SOT-143)	RA-4	4.50	1	MDU
ADM6315-45D1ART-RL	-40°C to +125°C	Small Outline Transistor (SOT-143)	RA-4	4.50	1	MDU
ADM6315-44D1ART-RL7	-40°C to +125°C	Small Outline Transistor (SOT-143)	RA-4	4.39	1	MDT
ADM6315-44D1ART-RL	-40°C to +125°C	Small Outline Transistor (SOT-143)	RA-4	4.39	1	MDT
ADM6315-31D1ART-RL7	-40°C to +125°C	Small Outline Transistor (SOT-143)	RA-4	3.08	1	MDG
ADM6315-31D1ART-RL	-40°C to +125°C	Small Outline Transistor (SOT-143)	RA-4	3.08	1	MDG
ADM6315-29D1ART-RL7	-40°C to +125°C	Small Outline Transistor (SOT-143)	RA-4	2.93	1	MDC
ADM6315-29D1ART-RL	-40°C to +125°C	Small Outline Transistor (SOT-143)	RA-4	2.93	1	MDC
ADM6315-26D1ART-RL7	-40°C to +125°C	Small Outline Transistor (SOT-143)	RA-4	2.63	1	MDB
ADM6315-26D1ART-RL	-40°C to +125°C	Small Outline Transistor (SOT-143)	RA-4	2.63	1	MDB
ADM6315-46D2ART-RL7	-40°C to +125°C	Small Outline Transistor (SOT-143)	RA-4	4.63	20	MEV
ADM6315-46D2ART-RL	-40°C to +125°C	Small Outline Transistor (SOT-143)	RA-4	4.63	20	MEV
ADM6315-45D2ART-RL7	-40°C to +125°C	Small Outline Transistor (SOT-143)	RA-4	4.50	20	MEU
ADM6315-45D2ART-RL	-40°C to +125°C	Small Outline Transistor (SOT-143)	RA-4	4.50	20	MEU
ADM6315-44D2ART-RL7	-40°C to +125°C	Small Outline Transistor (SOT-143)	RA-4	4.39	20	MET
ADM6315-44D2ART-RL	-40°C to +125°C	Small Outline Transistor (SOT-143)	RA-4	4.39	20	MET
ADM6315-31D2ART-RL7	-40°C to +125°C	Small Outline Transistor (SOT-143)	RA-4	3.08	20	MEG
ADM6315-31D2ART-RL	-40°C to +125°C	Small Outline Transistor (SOT-143)	RA-4	3.08	20	MEG
ADM6315-29D2ART-RL7	-40°C to +125°C	Small Outline Transistor (SOT-143)	RA-4	2.93	20	MEC
ADM6315-29D2ART-RL	-40°C to +125°C	Small Outline Transistor (SOT-143)	RA-4	2.93	20	MEC
ADM6315-26D2ART-RL7	-40°C to +125°C	Small Outline Transistor (SOT-143)	RA-4	2.63	20	MEB
ADM6315-26D2ART-RL	-40°C to +125°C	Small Outline Transistor (SOT-143)	RA-4	2.63	20	MEB
ADM6315-46D3ART-RL7	-40°C to +125°C	Small Outline Transistor (SOT-143)	RA-4	4.63	140	MFV
ADM6315-46D3ART-RL	-40°C to +125°C	Small Outline Transistor (SOT-143)	RA-4	4.63	140	MFV
ADM6315-45D3ART-RL7	-40°C to +125°C	Small Outline Transistor (SOT-143)	RA-4	4.50	140	MFU
ADM6315-45D3ART-RL	-40°C to +125°C	Small Outline Transistor (SOT-143)	RA-4	4.50	140	MFU
ADM6315-44D3ART-RL7	-40°C to +125°C	Small Outline Transistor (SOT-143)	RA-4	4.39	140	MFT
ADM6315-44D3ART-RL	-40°C to +125°C	Small Outline Transistor (SOT-143)	RA-4	4.39	140	MFT
ADM6315-31D3ART-RL7	-40°C to +125°C	Small Outline Transistor (SOT-143)	RA-4	3.08	140	MFG
ADM6315-31D3ART-RL	-40°C to +125°C	Small Outline Transistor (SOT-143)	RA-4	3.08	140	MFG
ADM6315-29D3ART-RL7	-40°C to +125°C	Small Outline Transistor (SOT-143)	RA-4	2.93	140	MFC
ADM6315-29D3ART-RL	-40°C to +125°C	Small Outline Transistor (SOT-143)	RA-4	2.93	140	MFC
ADM6315-26D3ART-RL7	-40°C to +125°C	Small Outline Transistor (SOT-143)	RA-4	2.63	140	MFB
ADM6315-26D3ART-RL	-40°C to +125°C	Small Outline Transistor (SOT-143)	RA-4	2.63	140	MFB
ADM6315-46D4ART-RL7	-40°C to +125°C	Small Outline Transistor (SOT-143)	RA-4	4.63	1120	MGV
ADM6315-46D4ART-RL	-40°C to +125°C	Small Outline Transistor (SOT-143)	RA-4	4.63	1120	MGV
ADM6315-45D4ART-RL7	-40°C to +125°C	Small Outline Transistor (SOT-143)	RA-4	4.50	1120	MGU
ADM6315-45D4ART-RL	-40°C to +125°C	Small Outline Transistor (SOT-143)	RA-4	4.50	1120	MGU
ADM6315-44D4ART-RL7	-40°C to +125°C	Small Outline Transistor (SOT-143)	RA-4	4.39	1120	MGT
ADM6315-44D4ART-RL	-40°C to +125°C	Small Outline Transistor (SOT-143)	RA-4	4.39	1120	MGT
ADM6315-31D4ART-RL7	-40°C to +125°C	Small Outline Transistor (SOT-143)	RA-4	3.08	1120	MGG
ADM6315-31D4ART-RL	-40°C to +125°C	Small Outline Transistor (SOT-143)	RA-4	3.08	1120	MGG
ADM6315-29D4ART-RL7	-40°C to +125°C	Small Outline Transistor (SOT-143)	RA-4	2.93	1120	MGC
ADM6315-29D4ART-RL	-40°C to +125°C	Small Outline Transistor (SOT-143)	RA-4	2.93	1120	MGC
ADM6315-26D4ART-RL7	-40°C to +125°C	Small Outline Transistor (SOT-143)	RA-4	2.63	1120	MGB
ADM6315-26D4ART-RL	-40°C to +125°C	Small Outline Transistor (SOT-143)	RA-4	2.63	1120	MGB

Typical Performance Characteristics—ADM6315

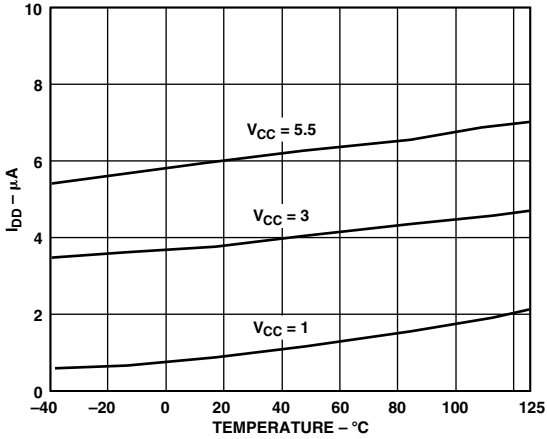

TPC 1. Supply Current vs. Temperature

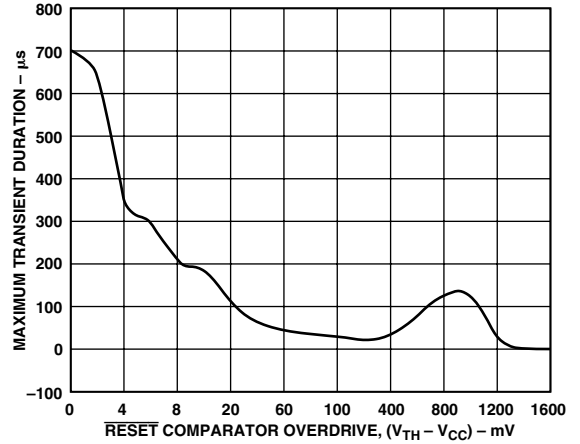

TPC 4. Maximum Transient Duration vs. $\overline{\text{RESET}}$ Comparator Overdrive

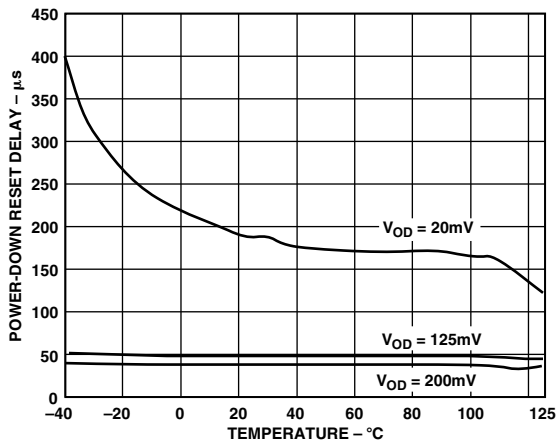

TPC 2. Power-Down Reset Delay vs. Temperature

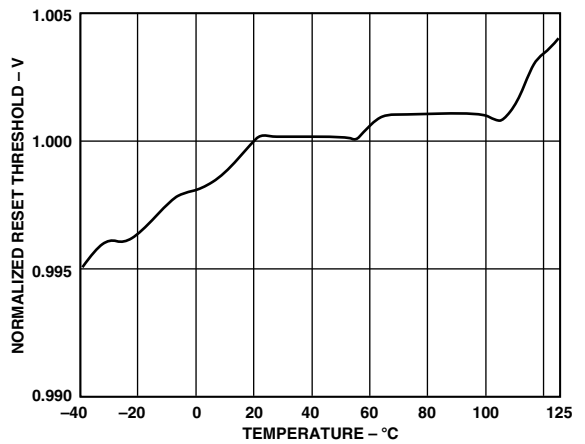

TPC 5. Normalized Reset Threshold vs. Temperature (V_{CC} Falling)

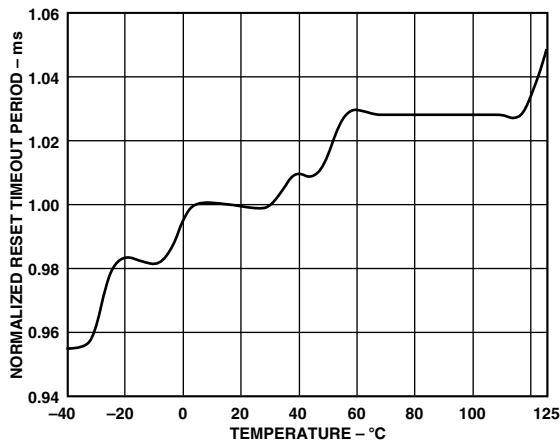

TPC 3. Normalized Reset Timeout Period vs. Temperature (V_{CC} Rising)

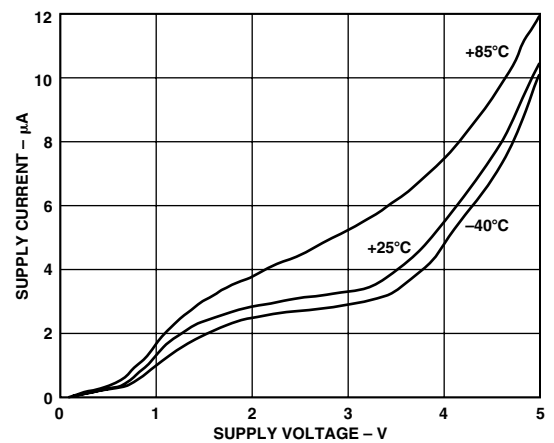

TPC 6. Supply Current vs. Supply Voltage

ADM6315

INTERFACING TO OTHER DEVICES' OUTPUT

The ADM6315 series is designed to integrate with as many devices as possible. One feature of the ADM6315 is the $\overline{\text{RESET}}$ open-drain output, which can sink current from sources with a voltage greater than the V_{CC} of the ADM6315 input, making it suitable for use in more diverse applications.

BENEFITS OF A VERY ACCURATE RESET THRESHOLD

Because the ADM6315 series can operate effectively even when there are large degradations of the supply voltages (due to an accurate internal voltage reference circuit), the possibility of a malfunction during a power failure is greatly reduced.

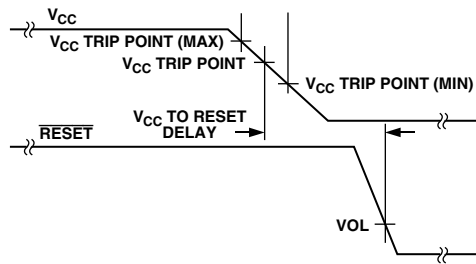

Figure 2. V_{CC} Power-Down/Brownout Timing Diagram

DETAILED DESCRIPTION

The ADM6315 is designed to protect the integrity of a system's operation by ensuring the proper operation of the system during power-up, power-down, and brownout conditions.

When the ADM6315 is powered up (depending on the selected reset active timeout), the $\overline{\text{RESET}}$ output of the ADM6315 remains low for a period typically equal to the reset active timeout period. This is designed to give the system time to power up correctly and for the power supply to stabilize before any devices are brought out of reset and allowed to begin executing instructions. Initializing a system in this way provides a more reliable startup for microprocessor systems.

When a brownout condition occurs (assuming V_{CC} is falling at $1 \text{ mV}/\mu\text{s}$), the ADM6315 produces a reset in typically $35 \mu\text{s}$. Producing a reset this fast means that the entire system can be reset together before any part of the system's voltage falls below its recommended operating voltage. This can avoid dangerous and/or erroneous operation of a microprocessor based system.

MANUAL RESET INPUT

The ADM6315 also provides an additional input, $\overline{\text{MR}}$. This input can be used either as a means for the system operator to manually reset the system via a switch or for a digital circuit to reset the system.

The $\overline{\text{MR}}$ input (typically) ignores negative going pulses faster than 100 ns and is guaranteed to accept any negative going input pulse of a duration greater than or equal to $1 \mu\text{s}$. If $\overline{\text{MR}}$ is connected to long cables or is used in a noisy environment, then placing a $1 \mu\text{F}$ decoupling capacitor between the $\overline{\text{MR}}$ input and ground further improves the glitch immunity of the ADM6315.

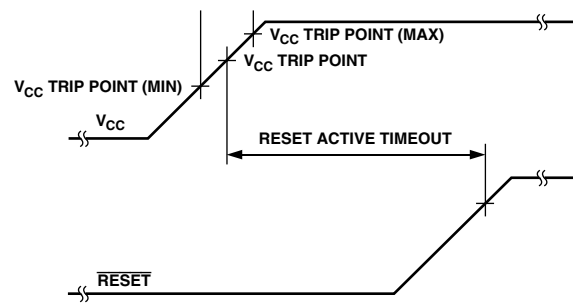

Figure 3. V_{CC} Power-Up Timing Diagram

TRANSIENT IMMUNITY

As well as being an accurate reset circuit, the ADM6315 has good immunity to negative going transients (TPC 4). Because of this characteristic, the ADM6315 is suitable for use in noisy environments.

TPC 4 shows the reset comparator overdrive (the maximum magnitude of negative going pulses with respect to the typical reset threshold) versus the pulse duration, without causing a reset.

ADM6315

Revision History

Location	Page
12/03—Data Sheet changed from REV. B to REV. C.	
Edit to ABSOLUTE MAXIMUM RATINGS	3
Edits to ORDERING GUIDE	4
Deleted Table I and Table II	6
Deleted Table III and Table IV	7
Updated OUTLINE DIMENSIONS	8
2/03—Data Sheet changed from REV. A to REV. B.	
Edits to FEATURES	1
Edits to SPECIFICATIONS	2
Edits to ABSOLUTE MAXIMUM RATINGS	3
Edits to ORDERING GUIDE	3
Edits to Table I and Table II	6
Edits to Table III and Table IV	7
Updated OUTLINE DIMENSIONS	8
10/01—Data Sheet changed from REV. 0 to REV. A.	
Edits to Table III	7
Edits to Table IV	7

C00081-0-12/03(C)

This datasheet has been download from:

www.datasheetcatalog.com

Datasheets for electronics components.