

Dual Ultra Low Noise Amplifier

The EL1516 is a dual, ultra low noise amplifier, ideally suited to line receiving applications in ADSL, VDSL, and home PNA designs. With low noise specification of just $1.3\text{nV}/\sqrt{\text{Hz}}$ and $1.5\text{pA}/\sqrt{\text{Hz}}$, the EL1516 is perfect for the detection of very low amplitude signals.

The EL1516 features a -3dB bandwidth of 350MHz @ $A_V = -1$ and is gain-of-2 stable. The EL1516 also affords minimal power dissipation with a supply current of just 5.5mA per amplifier. The amplifier can be powered from supplies ranging from 5V to 12V.

The EL1516A incorporates an enable and disable function to reduce the supply current to 5nA typical per amplifier, allowing the $\overline{\text{EN}}$ pins to float or apply a low logic level will enable the amplifiers.

The EL1516 is available in space-saving 8-pin MSOP and industry-standard 8-pin SO packages and the EL1516A is available in a 10-pin MSOP package. All are specified for operation over the -40°C to $+85^\circ\text{C}$ temperature range.

Pinouts

EL1516
(8-PIN SO, MSOP)
TOP VIEW

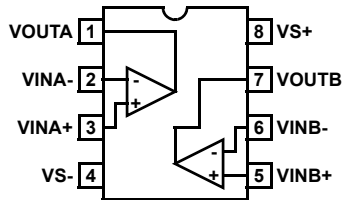

EL1516A
(10-PIN MSOP)
TOP VIEW

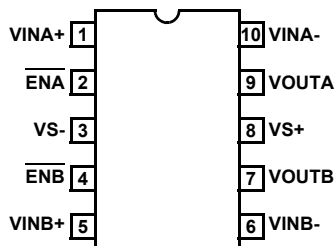

Features

- EL2227 upgrade replacement
- Voltage noise of only $1.3\text{nV}/\sqrt{\text{Hz}}$
- Current noise of only $1.5\text{pA}/\sqrt{\text{Hz}}$
- Bandwidth (-3dB) of 350MHz @ $A_V = -1$
- Bandwidth (-3dB) of 250MHz @ $A_V = +2$
- Gain-of-2 stable
- Just 5.5mA per amplifier
- $100\text{mA } I_{\text{OUT}}$
- Fast enable/disable (EL1516A only)
- 5V to 12V operation
- Pb-free available (RoHS compliant)

Applications

- ADSL receivers
- VDSL receivers
- Home PNA receivers
- Ultrasound input amplifiers
- Wideband instrumentation
- Communications equipment
- AGC & PLL active filters
- Wideband sensors

Ordering Information

PART NUMBER	PACKAGE	TAPE & REEL	PKG. DWG. #
EL1516IY	8-Pin MSOP	-	MDP0043
EL1516IY-T13	8-Pin MSOP	13"	MDP0043
EL1516IY-T7	8-Pin MSOP	7"	MDP0043
EL1516IYZ (See Note)	8-Pin MSOP (Pb-free)	-	MDP0043
EL1516IYZ-T13 (See Note)	8-Pin MSOP (Pb-free)	13"	MDP0043
EL1516IYZ-T7 (See Note)	8-Pin MSOP (Pb-free)	7"	MDP0043
EL1516IS	8-Pin SO	-	MDP0027
EL1516IS-T13	8-Pin SO	13"	MDP0027
EL1516IS-T7	8-Pin SO	7"	MDP0027
EL1516ISZ (See Note)	8-Pin SO (Pb-free)	-	MDP0027
EL1516ISZ-T13 (See Note)	8-Pin SO (Pb-free)	13"	MDP0027
EL1516ISZ-T7 (See Note)	8-Pin SO (Pb-free)	7"	MDP0027
EL1516AIY	10-Pin MSOP	-	MDP0043
EL1516AIY-T13	10-Pin MSOP	13"	MDP0043
EL1516AIY-T7	10-Pin MSOP	7"	MDP0043
EL1516AIYZ (See Note)	10-Pin MSOP (Pb-free)	-	MDP0043
EL1516AIYZ-T13 (See Note)	10-Pin MSOP (Pb-free)	13"	MDP0043
EL1516AIYZ-T7 (See Note)	10-Pin MSOP (Pb-free)	7"	MDP0043

NOTE: Intersil Pb-free products employ special Pb-free material sets; molding compounds/die attach materials and 100% matte tin plate termination finish, which are RoHS compliant and compatible with both SnPb and Pb-free soldering operations. Intersil Pb-free products are MSL classified at Pb-free peak reflow temperatures that meet or exceed the Pb-free requirements of IPC/JEDEC J STD-020.

EL1516, EL1516A

Absolute Maximum Ratings (T_A = 25°C)

Supply Voltage between V _{S+} and V _{S-}	14V	Storage Temperature	-65°C to +150°C
Input Voltage	V _{S-} -0.3V, V _S +0.3V	Operating Temperature	-40°C to +85°C
Maximum Continuous Output Current	40mA	Power Dissipation	See Curves
Maximum Die Temperature	150°C		

CAUTION: Stresses above those listed in "Absolute Maximum Ratings" may cause permanent damage to the device. This is a stress only rating and operation of the device at these or any other conditions above those indicated in the operational sections of this specification is not implied.

IMPORTANT NOTE: All parameters having Min/Max specifications are guaranteed. Typ values are for information purposes only. Unless otherwise noted, all tests are at the specified temperature and are pulsed tests, therefore: T_J = T_C = T_A

Electrical Specifications V_{S+} = +2.5V, V_{S-} = -2.5V, R_L = 500Ω and C_L = 3pF to 0V, R_F = R_G = 620Ω, V_{CM} = 0V, and T_A = 25°C, unless otherwise specified.

PARAMETER	DESCRIPTION	CONDITIONS	MIN	TYP	MAX	UNIT
INPUT CHARACTERISTICS						
V _{OS}	Input Offset Voltage	V _{CM} = 0V		-0.2	+3	mV
TCV _{OS}	Average Offset Voltage Drift			-0.3		μV/°C
I _B	Input Bias Current	V _{CM} = 0V		6.5	9	μA
I _{OS}	Input Offset Current			50	500	nA
R _{IN}	Input Impedance			2		MΩ
C _{IN}	Input Capacitance			1.6		pF
CMIR	Common-Mode Input Range		-1.3		+1.7	V
CMRR	Common-Mode Rejection Ratio	for V _{IN} from -4.7V to 5.4V	85	105		dB
A _{VOL}	Open-Loop Gain	V _O = ±1.25V	70	75		dB
e _n	Voltage Noise	f = 100kHz		1.24		nV/√Hz
i _n	Current Noise	f = 100kHz		1.5		pA/√Hz
OUTPUT CHARACTERISTICS						
V _{OL}	Output Swing Low	R _L = 500Ω		1.45	1.35	V
		R _L = 150Ω		1.37	1.25	V
V _{OH}	Output Swing High	R _L = 500Ω	1.5	1.6		V
		R _L = 150Ω	1.4	1.5		V
I _{SC}	Short Circuit Current	R _L = 10Ω	60	75		mA
POWER SUPPLY PERFORMANCE						
PSRR	Power Supply Rejection Ratio	V _S is moved from ±5.4V to ±6.6V	75	80		dB
I _{S ON}	Supply Current Enable (Per Amplifier)	No load		5.7	7	mA
I _{S OFF}	Supply Current Disable (Per Amplifier) (EL1516A)	I+ (DIS)		2	5	μA
		I- (DIS)	-19	-16		μA
TC I _S	I _S Temperature Coefficient			32		μA/°C
V _S	Operating Range		5		12	V
DYNAMIC PERFORMANCE						
SR	Slew Rate	V _O = ±1.25V square wave, measured 25%-75%	80	110		V/μs
TC SR	SR Temperature Coefficient			0.5		V/μs/°C
t _S	Settling to 0.1% (A _V = +2)	A _V = +2, V _O = ±1V		25		ns
BW1	-3dB Bandwidth	A _V = -1, R _F = 100Ω		320		MHz
BW2	-3dB Bandwidth	A _V = +2, R _F = 100Ω		200		MHz

EL1516, EL1516A

Electrical Specifications $V_{S+} = +2.5V$, $V_{S-} = -2.5V$, $R_L = 500\Omega$ and $C_L = 3pF$ to $0V$, $R_F = R_G = 620\Omega$, $V_{CM} = 0V$, and $T_A = 25^\circ C$, unless otherwise specified. **(Continued)**

PARAMETER	DESCRIPTION	CONDITIONS	MIN	TYP	MAX	UNIT
HD2	2nd Harmonic Distortion	$f = 1MHz$, $V_O = 2V_{P-P}$, $R_L = 100\Omega$		90		dBc
HD3	3rd Harmonic Distortion	$f = 1MHz$, $V_O = 2V_{P-P}$, $R_L = 100\Omega$		95		dBc
ENABLE (EL1516AIY ONLY)						
t_{EN}	Enable Time			125		ns
t_{DIS}	Disable Time			336		ns
I_{IHEN}	\overline{EN} Pin Input High Current	$\overline{EN} = V_{S+}$		18		μA
I_{ILEN}	\overline{EN} Pin Input Low Current	$\overline{EN} = V_{S-}$		10		nA
V_{IHEN}	\overline{EN} Pin Input High Voltage for Power-down			$V_{S+} - 1$		V
V_{IHEN}	\overline{EN} Pin Input Low Voltage for Power-up			$V_{S-} + 3$		V

Electrical Specifications $V_{S+} = +6V$, $V_{S-} = -6V$, $R_L = 500\Omega$ and $C_L = 3pF$ to $0V$, $R_F = R_G = 620\Omega$, $V_{CM} = 0V$, and $T_A = 25^\circ C$, unless otherwise specified.

PARAMETER	DESCRIPTION	CONDITIONS	MIN	TYP	MAX	UNIT
INPUT CHARACTERISTICS						
V_{OS}	Input Offset Voltage	$V_{CM} = 0V$		0.1	3	mV
TCV_{OS}	Average Offset Voltage Drift			-0.3		$\mu V/^\circ C$
I_B	Input Bias Current	$V_{CM} = 0V$		6.5	9	μA
I_{OS}	Input Offset Current			50	500	nA
R_{IN}	Input Impedance			12		$M\Omega$
C_{IN}	Input Capacitance			1.6		pF
CMIR	Common-Mode Input Range		-4.5		+5.5	V
CMRR	Common-Mode Rejection Ratio	for V_{IN} from -4.7V to 5.4V	90	110		dB
A_{VOL}	Open-Loop Gain	$V_O = \pm 2.5V$	75	80		dB
e_n	Voltage Noise	$f = 100kHz$		1.24		nV/\sqrt{Hz}
i_n	Current Noise	$f = 100kHz$		1.5		pA/\sqrt{Hz}
OUTPUT CHARACTERISTICS						
V_{OL}	Output Swing Low	$R_L = 500\Omega$		-4.8	-4.7	V
		$R_L = 150\Omega$		-4.6	-4.5	V
V_{OH}	Output Swing High	$R_L = 500\Omega$	4.8	4.9		V
		$R_L = 150\Omega$	4.5	4.7		V
I_{SC}	Short Circuit Current	$R_L = 10\Omega$	110	160		mA
POWER SUPPLY PERFORMANCE						
PSRR	Power Supply Rejection Ratio	V_S is moved from $\pm 5.4V$ to $\pm 6.6V$	75	85		dB
$I_{S ON}$	Supply Current Enable (Per Amplifier)	No load		5.8	7	mA
$I_{S OFF}$	Supply Current Disable (Per Amplifier) (EL1516A)	I+ (DIS)		2	5	μA
		I- (DIS)	-19	-16		μA
$TC I_S$	I_S Temperature Coefficient			32		$\mu A/^\circ C$
V_S	Operating Range		5		12	V

EL1516, EL1516A

Electrical Specifications $V_{S+} = +6V$, $V_{S-} = -6V$, $R_L = 500\Omega$ and $C_L = 3pF$ to 0V, $R_F = R_G = 620\Omega$, $V_{CM} = 0V$, and $T_A = 25^\circ C$, unless otherwise specified. **(Continued)**

PARAMETER	DESCRIPTION	CONDITIONS	MIN	TYP	MAX	UNIT
DYNAMIC PERFORMANCE						
SR	Slew Rate	$V_O = \pm 2.5V$ square wave, measured 25%-75%	90	128		V/ μs
TC SR	SR Temperature Coefficient			0.5		V/ $\mu s/^\circ C$
t_S	Settling to 0.1% ($A_V = +2$)	$A_V = +2$, $V_O = \pm 1V$		20		ns
BW1	-3dB Bandwidth	$A_V = -1$, $R_F = 100\Omega$		350		MHz
BW2	-3dB Bandwidth	$A_V = +2$, $R_F = 100\Omega$		250		MHz
HD2	2nd Harmonic Distortion	$f = 1MHz$, $V_O = 2V_{P-P}$, $R_L = 500\Omega$		125		dBc
		$f = 1MHz$, $V_O = 2V_{P-P}$, $R_L = 150\Omega$		117		dBc
HD3	3rd Harmonic Distortion	$f = 1MHz$, $V_O = 2V_{P-P}$, $R_L = 500\Omega$		115		dBc
		$f = 1MHz$, $V_O = 2V_{P-P}$, $R_L = 150\Omega$		110		dBc
ENABLE (EL1516AIY ONLY)						
t_{EN}	Enable Time			125		ns
t_{DIS}	Disable Time			336		ns
I_{IHEN}	\overline{EN} Pin Input High Current	$\overline{EN} = V_{S+}$		17	20	μA
I_{ILEN}	\overline{EN} Pin Input Low Current	$\overline{EN} = V_{S-}$		7	20	nA
V_{IHEN}	\overline{EN} Pin Input High Voltage for Power-down			$V_{S+} - 1$		V
V_{IHEN}	\overline{EN} Pin Input Low Voltage for Power-up			$V_{S-} + 3$		V

Typical Performance Curves

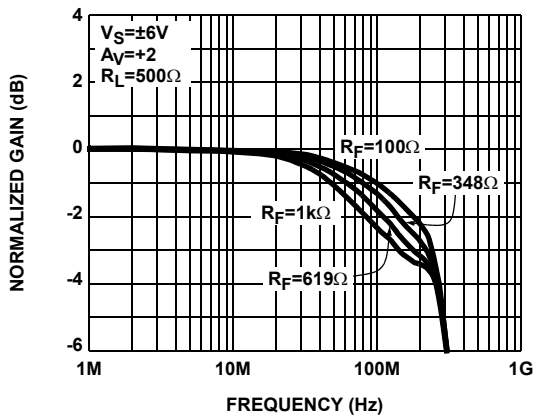

FIGURE 1. NON-INVERTING FREQUENCY RESPONSE FOR VARIOUS R_F

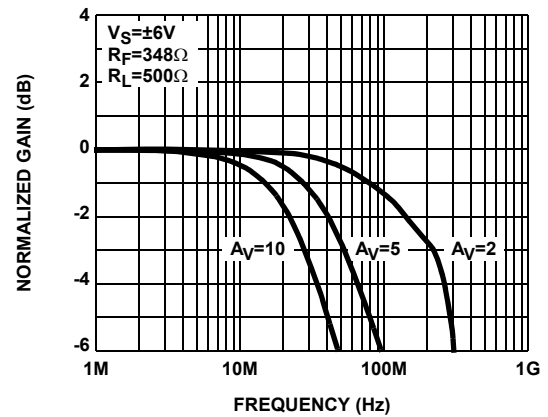

FIGURE 2. NON-INVERTING FREQUENCY RESPONSE (GAIN)

Typical Performance Curves (Continued)

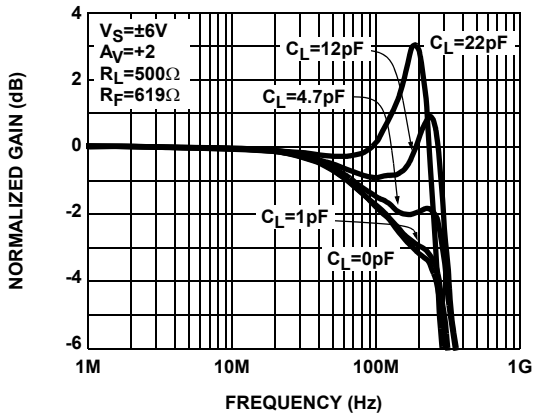

FIGURE 3. NON-INVERTING FREQUENCY RESPONSE FOR VARIOUS C_L

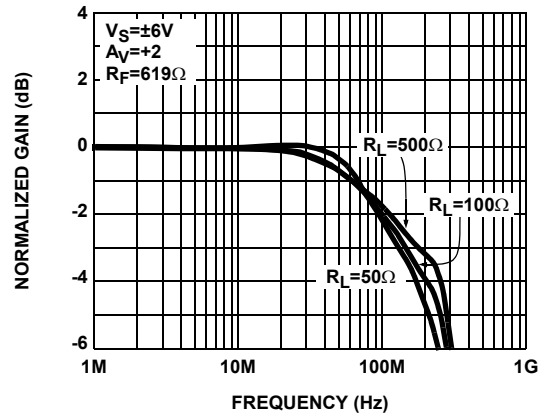

FIGURE 4. NON-INVERTING FREQUENCY RESPONSE FOR VARIOUS R_L

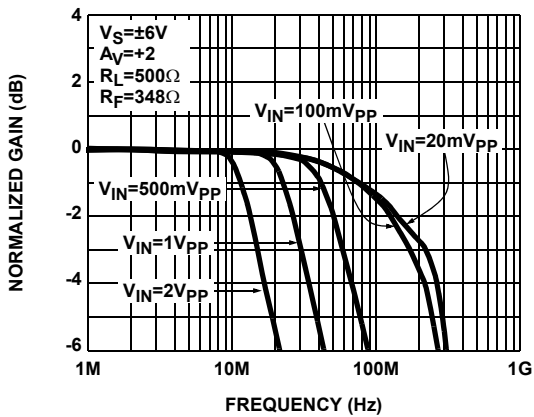

FIGURE 5. NON-INVERTING FREQUENCY RESPONSE FOR VARIOUS INPUT SIGNAL LEVELS

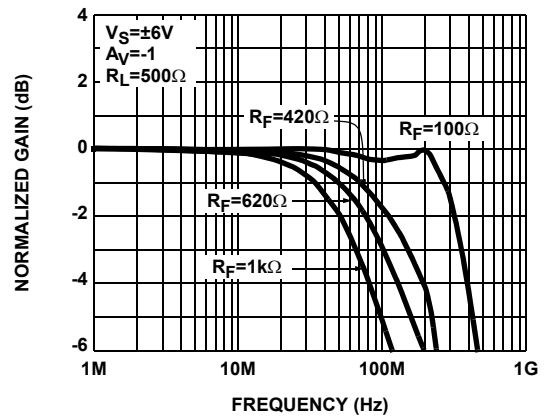

FIGURE 6. INVERTING FREQUENCY RESPONSE FOR VARIOUS R_F

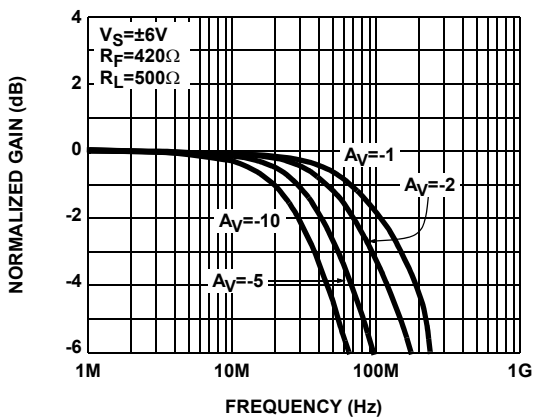

FIGURE 7. INVERTING FREQUENCY RESPONSE (GAIN)

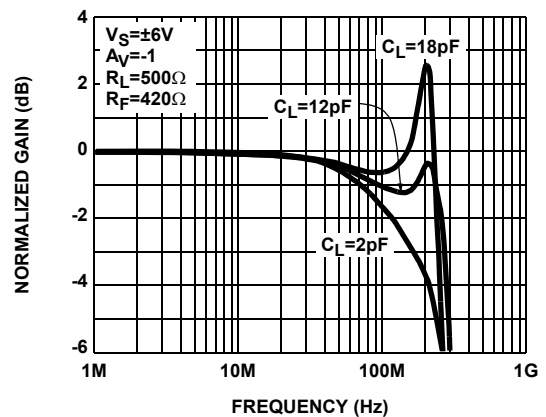

FIGURE 8. INVERTING FREQUENCY RESPONSE FOR VARIOUS C_L

Typical Performance Curves (Continued)

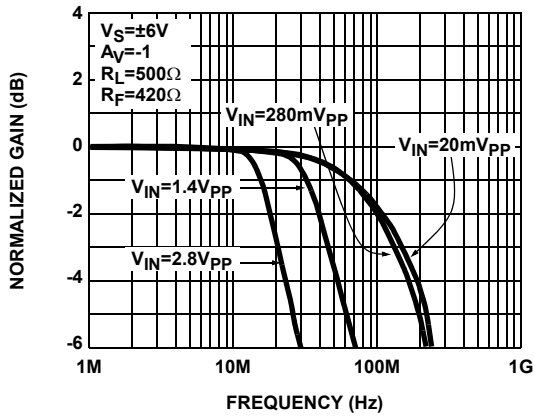

FIGURE 9. INVERTING FREQUENCY RESPONSE FOR VARIOUS SIGNAL LEVELS

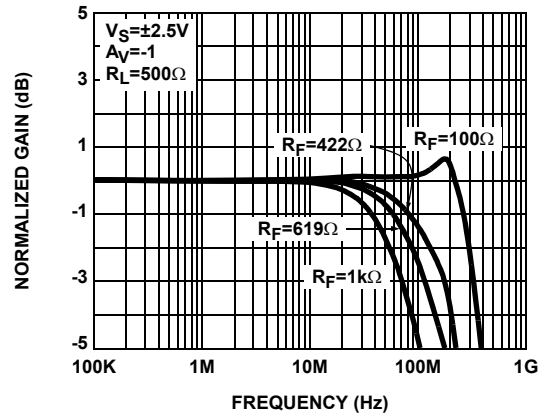

FIGURE 10. INVERTING FREQUENCY RESPONSE FOR VARIOUS R_F

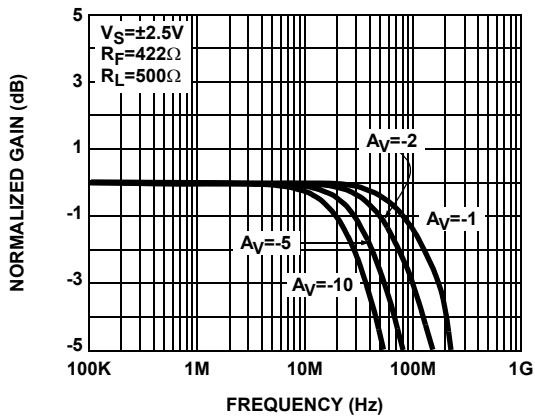

FIGURE 11. INVERTING FREQUENCY RESPONSE FOR VARIOUS A_V

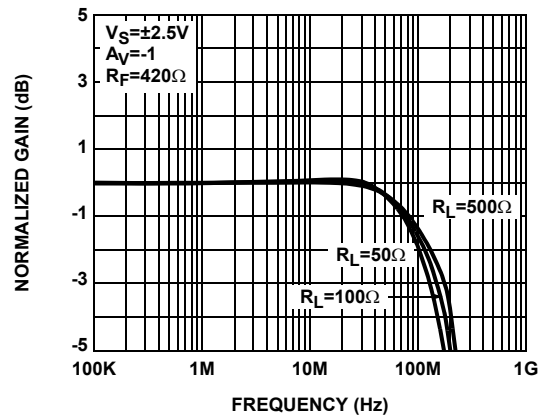

FIGURE 12. INVERTING FREQUENCY RESPONSE FOR VARIOUS R_L

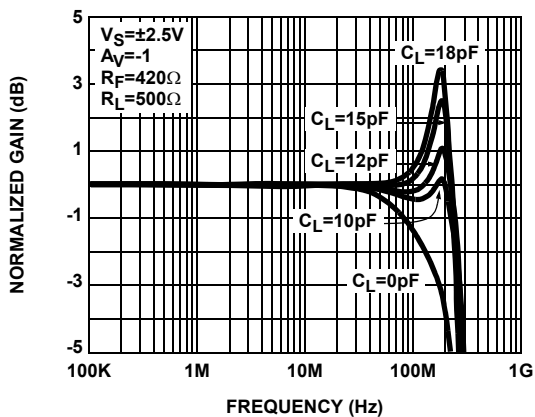

FIGURE 13. INVERTING FREQUENCY RESPONSE FOR VARIOUS C_L

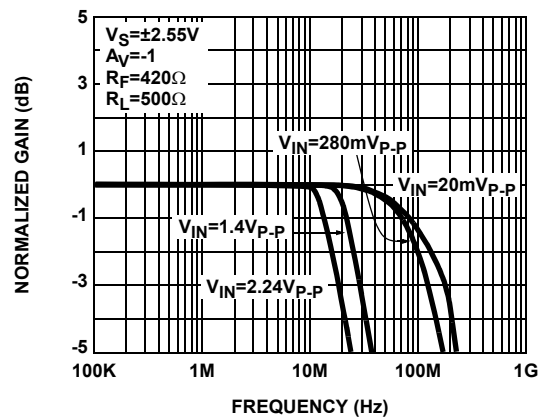

FIGURE 14. INVERTING FREQUENCY RESPONSE FOR VARIOUS INPUT SIGNAL LEVELS

Typical Performance Curves (Continued)

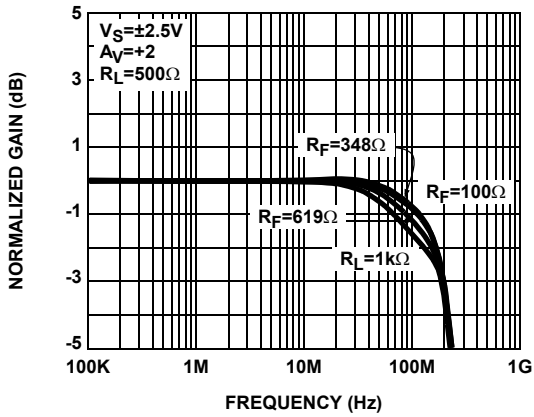

FIGURE 15. NON-INVERTING FREQUENCY RESPONSE FOR VARIOUS R_F

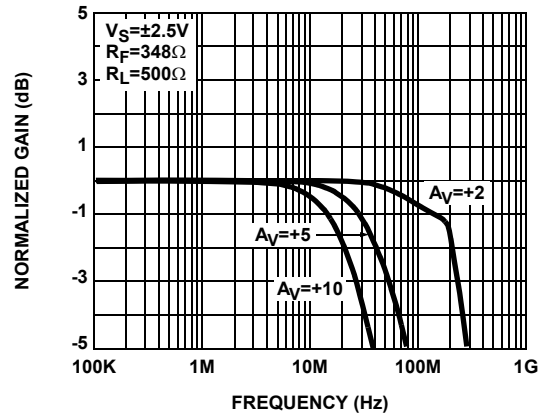

FIGURE 16. NON-INVERTING FREQUENCY RESPONSE FOR VARIOUS A_V

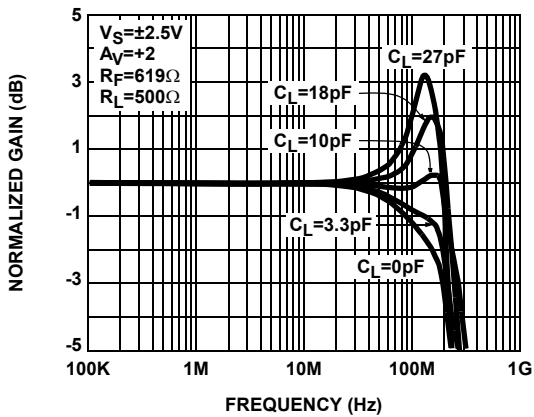

FIGURE 17. NON-INVERTING FREQUENCY RESPONSE FOR VARIOUS C_L

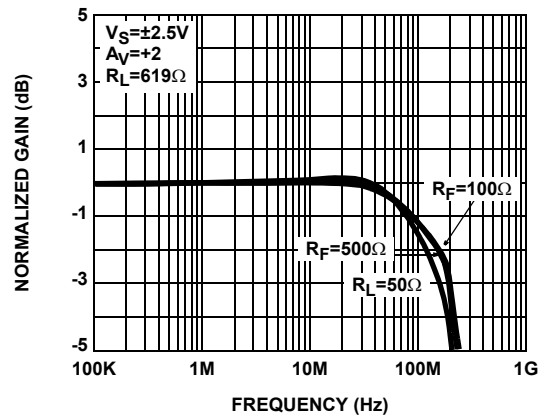

FIGURE 18. NON-INVERTING FREQUENCY RESPONSE FOR VARIOUS R_L

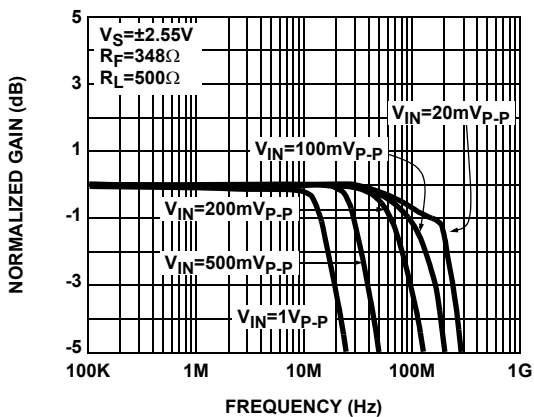

FIGURE 19. NON-INVERTING FREQUENCY RESPONSE FOR VARIOUS INPUT SIGNAL LEVELS

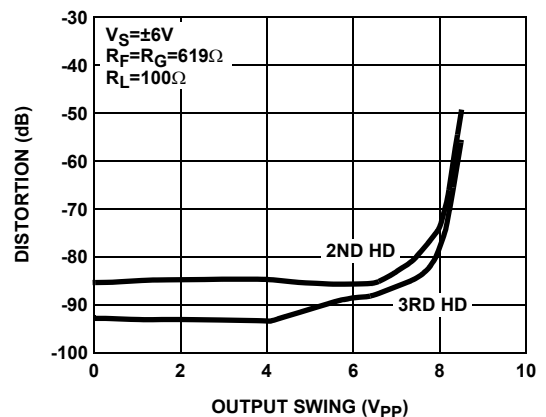

FIGURE 20. 1MHz 2ND AND 3RD HARMONIC DISTORTION vs OUTPUT SWING

Typical Performance Curves (Continued)

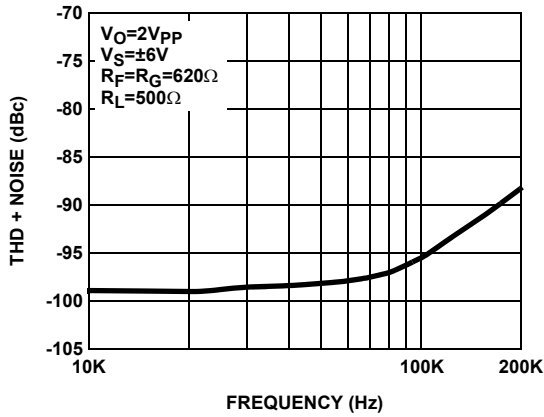

FIGURE 21. THD + NOISE vs FREQUENCY

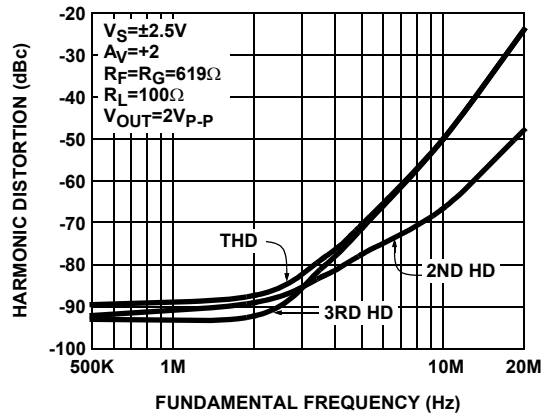

FIGURE 22. HARMONIC DISTORTION vs FREQUENCY

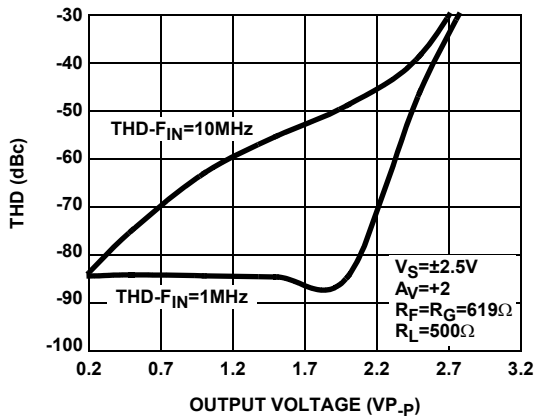

FIGURE 23. THD vs OUTPUT VOLTAGE

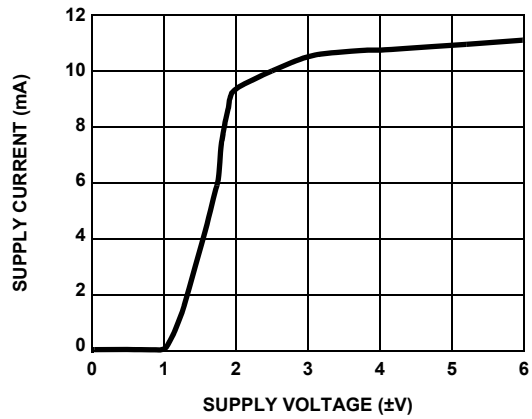

FIGURE 24. SUPPLY CURRENT vs SUPPLY VOLTAGE

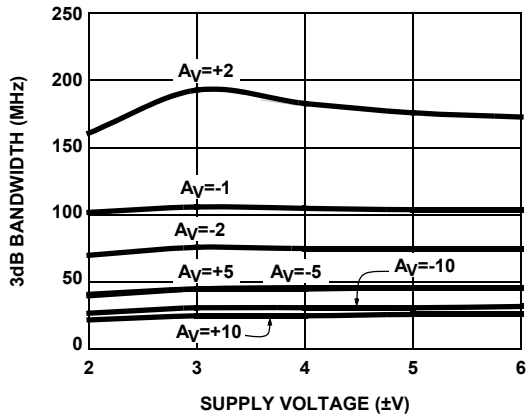

FIGURE 25. 3dB BANDWIDTH vs SUPPLY VOLTAGE

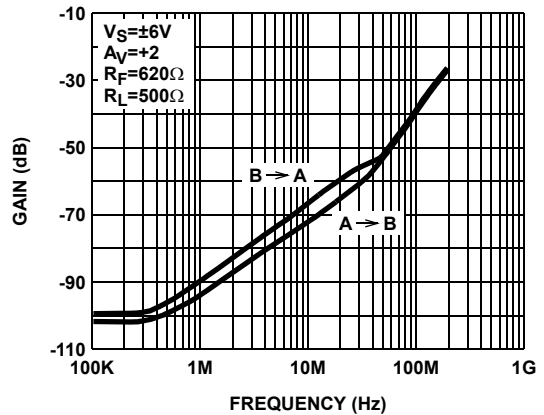

FIGURE 26. CHANNEL-TO-CHANNEL ISOLATION vs FREQUENCY

Typical Performance Curves (Continued)

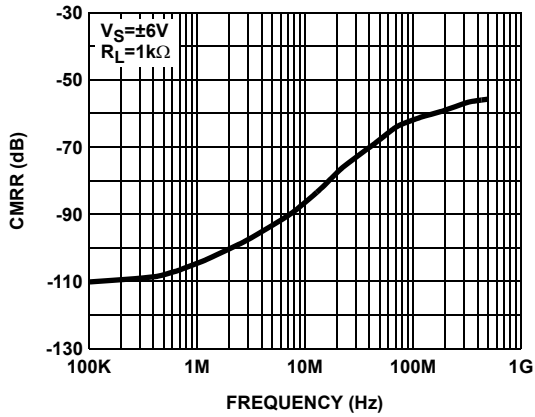

FIGURE 27. CMRR

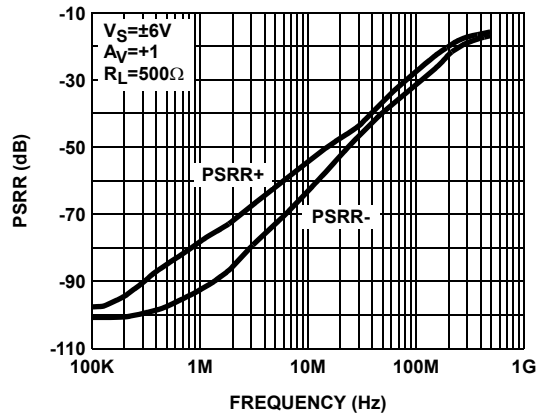

FIGURE 28. PSRR

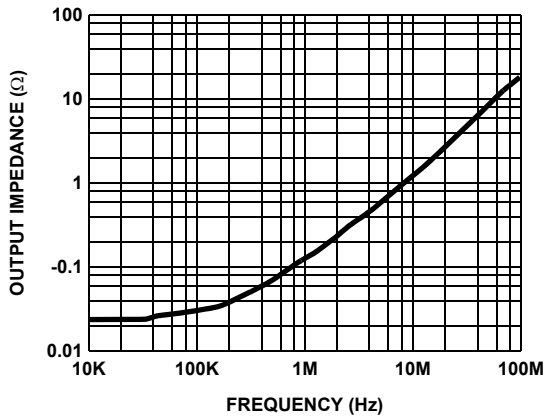

FIGURE 29. CLOSED LOOP OUTPUT IMPEDANCE vs FREQUENCY

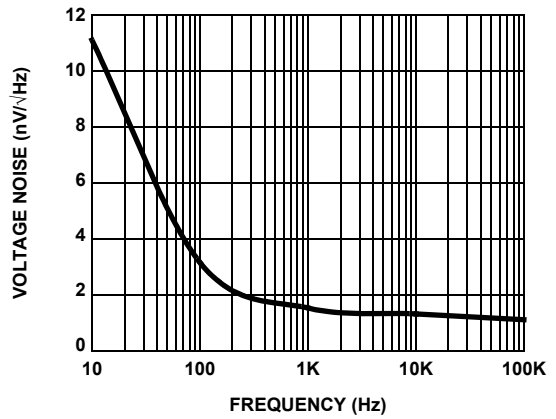

FIGURE 30. VOLTAGE NOISE

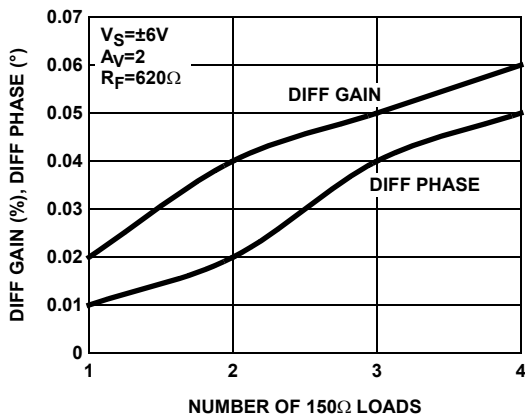

FIGURE 31. DIFFERENTIAL GAIN/PHASE

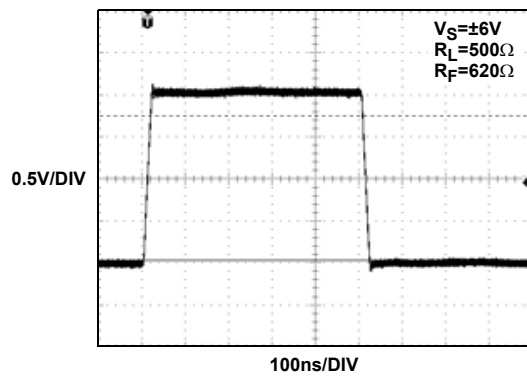

FIGURE 32. LARGE SIGNAL STEP RESPONSE

Typical Performance Curves (Continued)

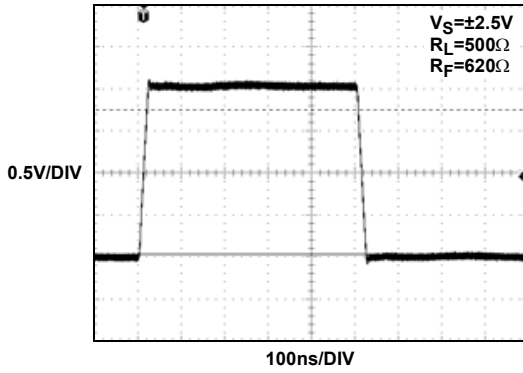

FIGURE 33. LARGE SIGNAL STEP RESPONSE

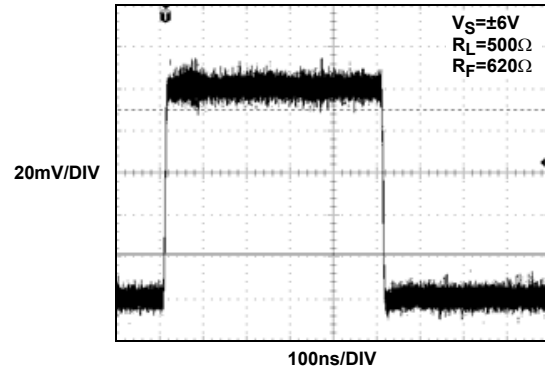

FIGURE 34. SMALL SIGNAL STEP RESPONSE

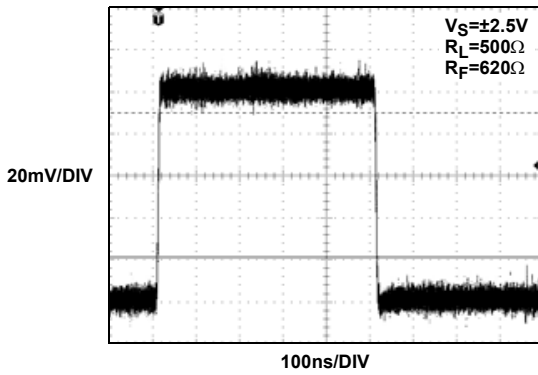

FIGURE 35. SMALL SIGNAL STEP RESPONSE

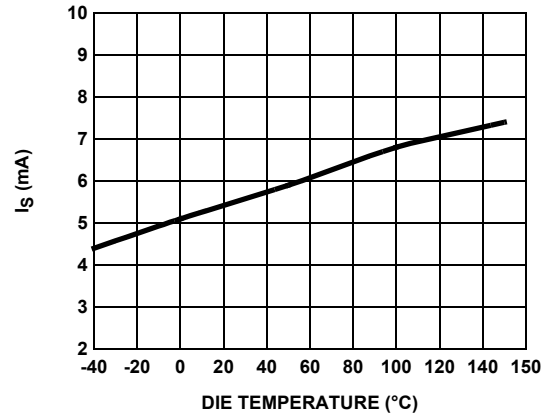

FIGURE 36. SUPPLY CURRENT vs TEMPERATURE

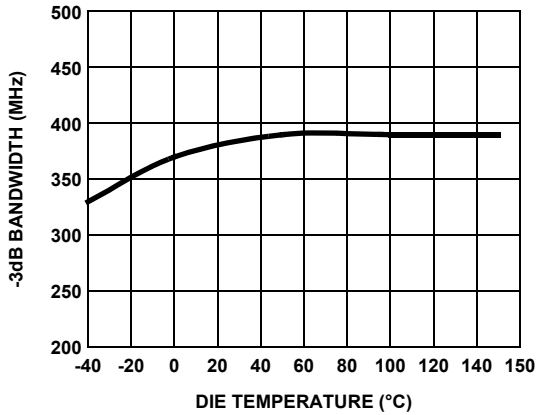

FIGURE 37. -3dB BANDWIDTH vs TEMPERATURE

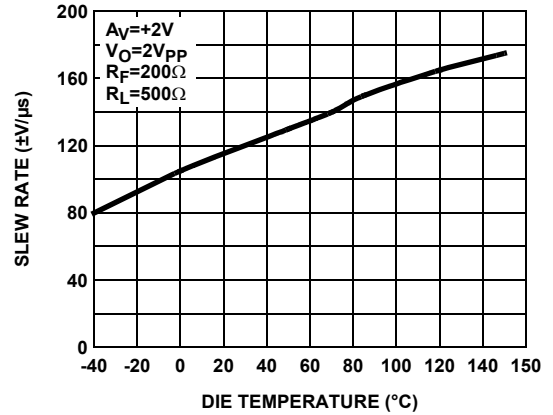

FIGURE 38. SLEW RATE vs TEMPERATURE

Typical Performance Curves (Continued)

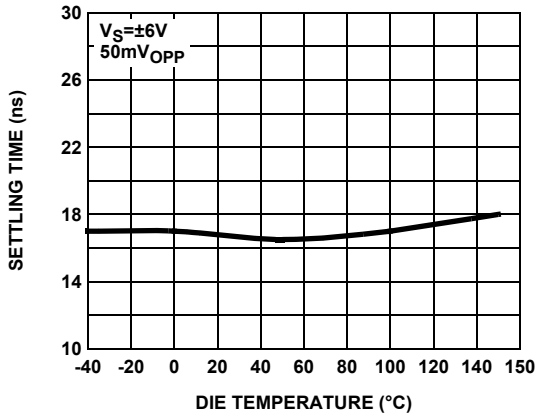

FIGURE 39. 0.1% SETTling TIME vs TEMPERATURE

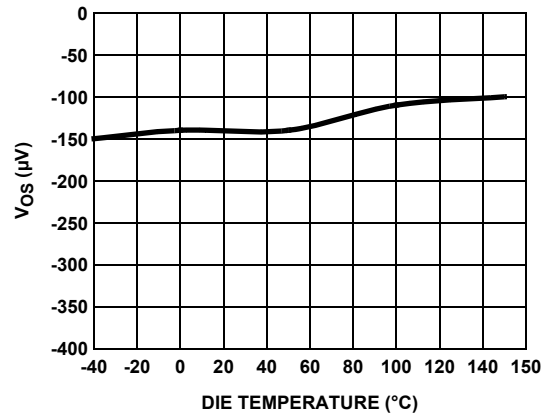

FIGURE 40. V_{OS} vs TEMPERATURE

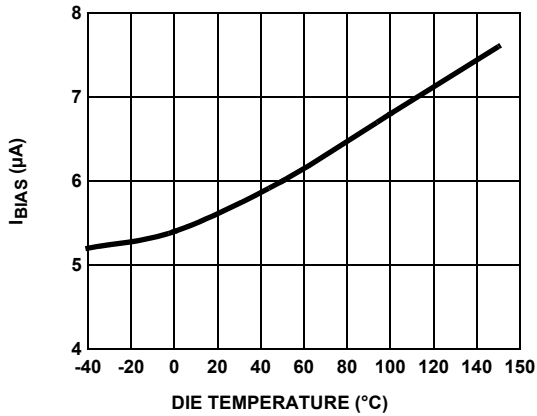

FIGURE 41. I_{BIAS} CURRENT vs TEMPERATURE

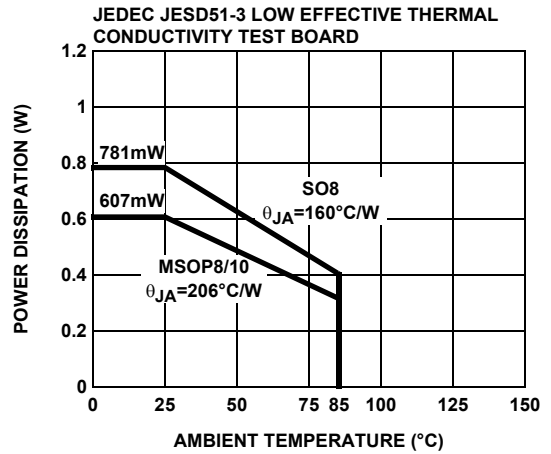

FIGURE 42. PACKAGE POWER DISSIPATION vs AMBIENT TEMPERATURE

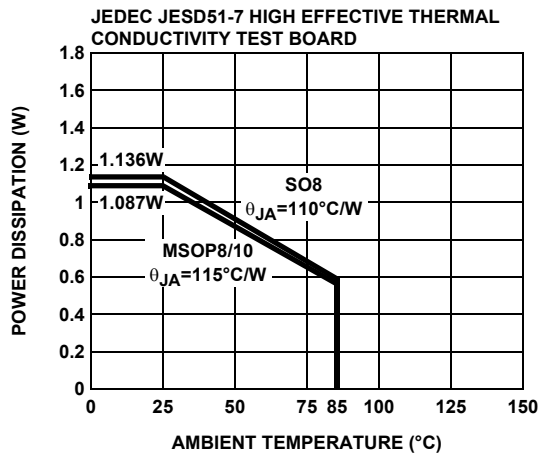
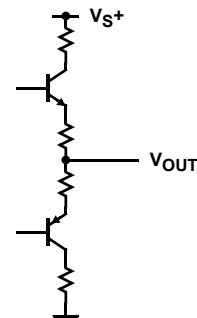
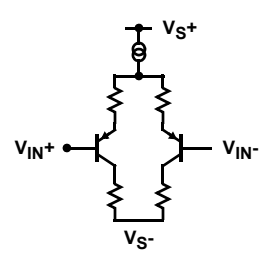
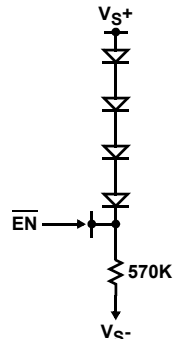

FIGURE 43. PACKAGE POWER DISSIPATION vs AMBIENT TEMPERATURE

Pin Descriptions

EL1516 (8-PIN SO & 8-PIN MSOP)	EL1516A (10-PIN MSOP)	PIN NAME	PIN FUNCTION	EQUIVALENT CIRCUIT
1	9	VOUTA	Output	 <p>CIRCUIT 1</p>
2	10	VINA-	Input	 <p>CIRCUIT 2</p>
3	1	VINA+	Input	Reference Circuit 2
4	3	VS-	Supply	
5	5	VINB+	Input	
6	6	VINB-	Input	Reference Circuit 2
7	7	VOUTB	Output	Reference Circuit 1
8	8	VS+	Supply	
	2, 4	$\overline{\text{ENA}}, \overline{\text{ENB}}$	Enable	 <p>CIRCUIT 3</p>

Applications Information

Product Description

The EL1516 is a dual voltage feedback operational amplifier designed especially for DMT ADSL and other applications requiring very low voltage and current noise. It also features low distortion while drawing moderately low supply current. The EL1516 uses a classical voltage-feedback topology which allows it to be used in a variety of applications where current-feedback amplifiers are not appropriate because of restrictions placed upon the feedback element used with the amplifier. The conventional topology of the EL1516 allows, for example, a capacitor to be placed in the feedback path, making it an excellent choice for applications such as active filters, sample-and-holds, or integrators.

ADSL CPE Applications

The low noise EL1516 amplifier is specifically designed for the dual differential receiver amplifier function with ADSL transceiver hybrids as well as other low-noise amplifier applications. A typical ADSL CPE line interface circuit is shown in Figure 44. The EL1516 is used in receiving DMT down stream signal. With careful transceiver hybrid design and the EL1516 1.4nV/√Hz voltage noise and 1.5pA/√Hz current noise performance, -140dBm/Hz system background noise performance can be easily achieved.

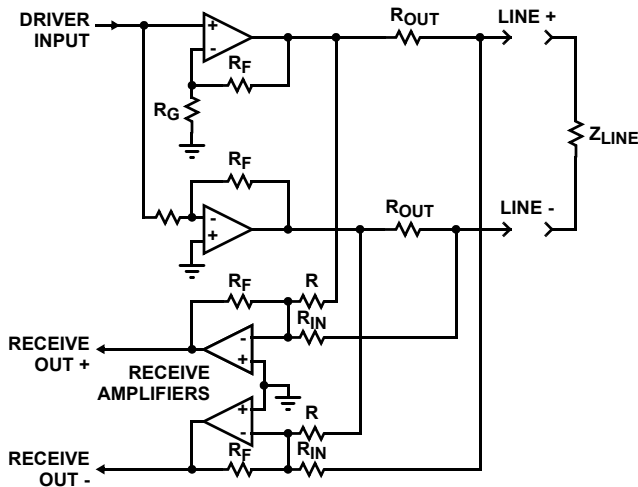

FIGURE 44. TYPICAL LINE INTERFACE CONNECTION

Power Dissipation

With the wide power supply range and large output drive capability of the EL1516, it is possible to exceed the 150°C maximum junction temperatures under certain load and power supply conditions. It is therefore important to calculate the maximum junction temperature (T_{JMAX}) for all applications to determine if power supply voltages, load conditions, or package type need to be modified for the

EL1516 to remain in the safe operating area. These parameters are related as follows:

$$T_{JMAX} = T_{MAX} + (\theta_{JA} \times PD_{MAXTOTAL})$$

where:

- $PD_{MAXTOTAL}$ is the sum of the maximum power dissipation of each amplifier in the package (PD_{MAX})
- PD_{MAX} for each amplifier can be calculated as follows:

$$PD_{MAX} = 2 \times V_S \times I_{SMAX} + (V_S - V_{OUTMAX}) \times \frac{V_{OUTMAX}}{R_L}$$

where:

- T_{MAX} = Maximum ambient temperature
- θ_{JA} = Thermal resistance of the package
- PD_{MAX} = Maximum power dissipation of 1 amplifier
- V_S = Supply voltage
- I_{MAX} = Maximum supply current of 1 amplifier
- V_{OUTMAX} = Maximum output voltage swing of the application
- R_L = Load resistance

To serve as a guide for the user, we can calculate maximum allowable supply voltages for the example of the video cable-driver below since we know that $T_{JMAX} = 150^\circ\text{C}$, $T_{MAX} = 75^\circ\text{C}$, $I_{SMAX} = 7.7\text{mA}$, and the package θ_{JA} s are shown in Table 1. If we assume (for this example) that we are driving a back-terminated video cable, then the maximum average value (over duty-cycle) of V_{OUTMAX} is 1.4V, and $R_L = 150\Omega$, giving the results seen in Table 1.

TABLE 1.

PART	PACKAGE	θ_{JA}	MAX P_{DISS} @ T_{MAX}	MAX V_S
EL1516IS	SO8	110°C/W	0.406W @ 85°C	
EL1516IY	MSOP8	115°C/W	0.400W @ 85°C	
EL1516AIY	MSOP10	115°C/W	0.400W @ 85°C	

Single-Supply Operation

The EL1516 has been designed to have a wide input and output voltage range. This design also makes the EL1516 an excellent choice for single-supply operation. Using a single positive supply, the lower input voltage range is within 1.2V of ground ($R_L = 500\Omega$), and the lower output voltage range is within 875mV of ground. Upper input voltage range reaches 3.6V, and output voltage range reaches 3.8V with a 5V supply and $R_L = 500\Omega$. This results in a 2.625V output swing on a single 5V supply. This wide output voltage range also

EL1516, EL1516A

allows single-supply operation with a supply voltage as high as 12V.

Gain-Bandwidth Product and the -3dB Bandwidth

The EL1516 has a gain-bandwidth product of 300MHz while using only 6mA of supply current per amplifier. For gains greater than 2, their closed-loop -3dB bandwidth is approximately equal to the gain-bandwidth product divided by the noise gain of the circuit. For gains less than 2, higher-order poles in the amplifiers' transfer function contribute to even higher closed loop bandwidths. For example, the EL1516 has a -3dB bandwidth of 350MHz at a gain of +2, dropping to 80MHz at a gain of +5. It is important to note that the EL1516 has been designed so that this "extra" bandwidth in low-gain applications does not come at the expense of stability. As seen in the typical performance curves, the EL1516 in a gain of +2 only exhibits 0.5dB of peaking with a 1000Ω load.

Output Drive Capability

The EL1516 has been designed to drive low impedance loads. It can easily drive 6V_{PP} into a 100Ω load. This high

output drive capability makes the EL1516 an ideal choice for RF, IF and video applications.

Printed-Circuit Layout

The EL1516 is well behaved, and easy to apply in most applications. However, a few simple techniques will help assure rapid, high quality results. As with any high-frequency device, good PCB layout is necessary for optimum performance. Ground-plane construction is highly recommended, as is good power supply bypassing. A 0.1μF ceramic capacitor is recommended for bypassing both supplies. Lead lengths should be as short as possible, and bypass capacitors should be as close to the device pins as possible. For good AC performance, parasitic capacitances should be kept to a minimum at both inputs and at the output. Resistor values should be kept under 5kΩ because of the RC time constants associated with the parasitic capacitance. Metal-film and carbon resistors are both acceptable, use of wire-wound resistors is not recommended because of their parasitic inductance. Similarly, capacitors should be low-inductance for best performance.

MSOP Package Outline Drawing

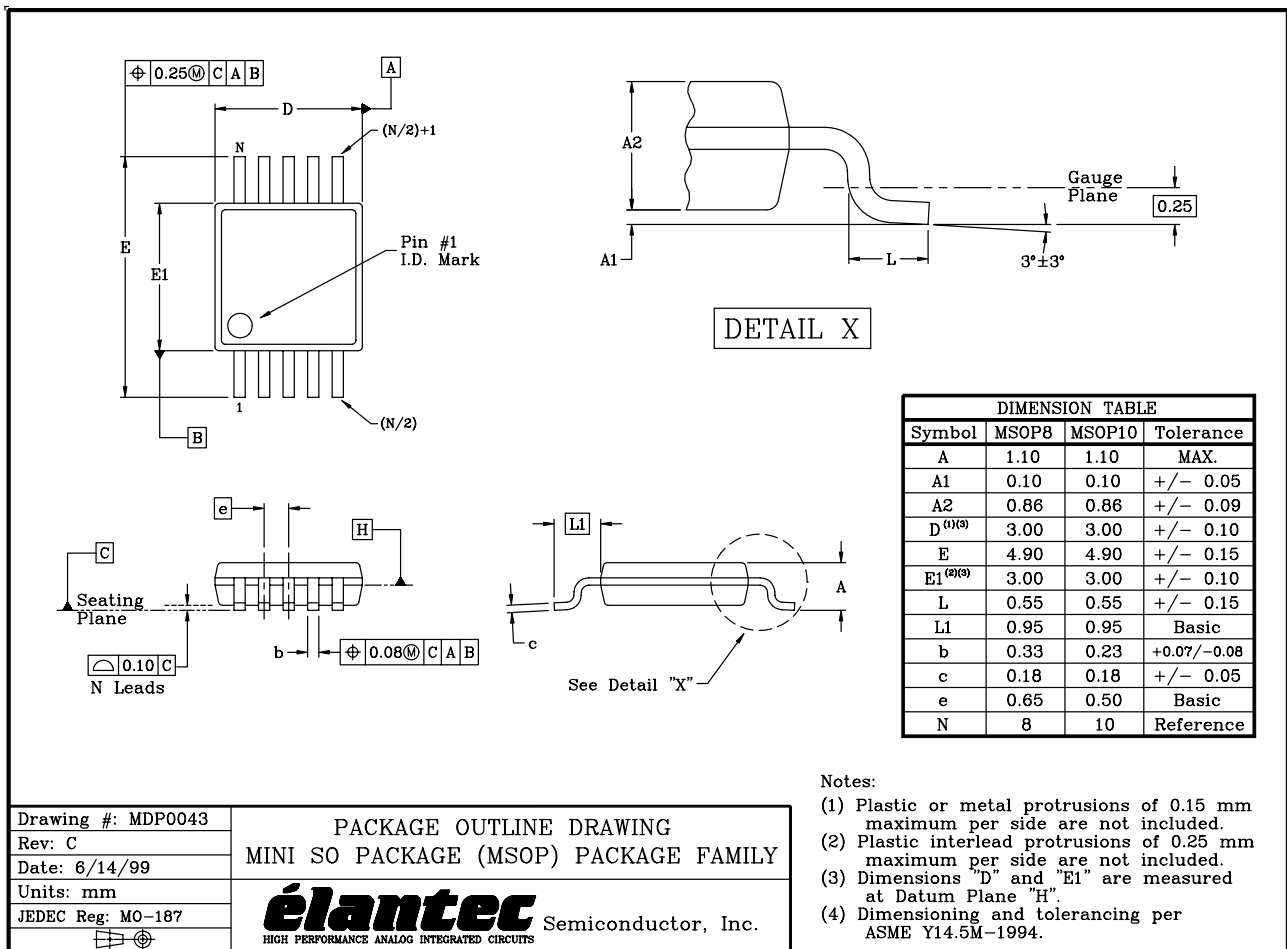

SO Package Outline Drawing

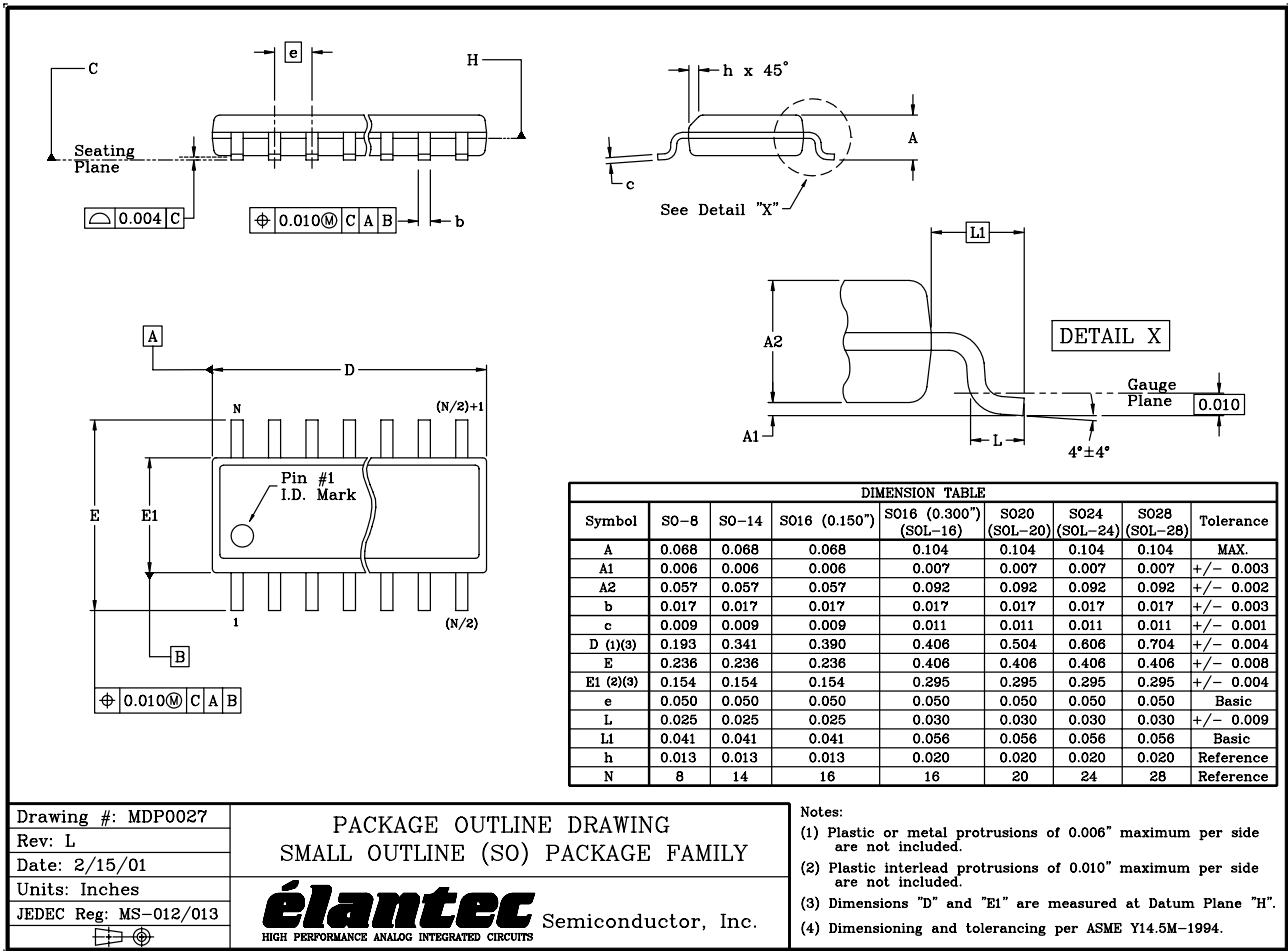

NOTE: The package drawing shown here may not be the latest version. To check the latest revision, please refer to the Intersil website at <http://www.intersil.com/design/packages/index.asp>

All Intersil U.S. products are manufactured, assembled and tested utilizing ISO9000 quality systems. Intersil Corporation's quality certifications can be viewed at www.intersil.com/design/quality

Intersil products are sold by description only. Intersil Corporation reserves the right to make changes in circuit design, software and/or specifications at any time without notice. Accordingly, the reader is cautioned to verify that data sheets are current before placing orders. Information furnished by Intersil is believed to be accurate and reliable. However, no responsibility is assumed by Intersil or its subsidiaries for its use; nor for any infringements of patents or other rights of third parties which may result from its use. No license is granted by implication or otherwise under any patent or patent rights of Intersil or its subsidiaries.

For information regarding Intersil Corporation and its products, see www.intersil.com